



825 Diligence Drive, Suite 205
Newport News, Virginia 23606
tel: 757 873-8850
fax: 757 596-2694

March 23, 2005

Harry F. Bailey
Environmental Engineer
Public Water Supply Section
Department of Environment and Natural Resources
943 Washington Square Mall
Washington, NC 27889

Subject: Well Completion Documents for Production Well Orville
Dare County Water System
PWS ID 04-28-030, Dare County

Dear Mr. Bailey:

On behalf of Dare County Water, CDM is pleased to inform you that Dare County's Production Well Orville has been constructed and tested by A.C. Schultes of Carolina, Inc. Attached for your information and review are four sets of well completion documents that include the following information:

- Signed Well Drillers Log
- Well Yield and Drawdown Report
- TDH and Pump Head Calculations
- Engineer's Well Construction Verification
- Well Site Deed and Plat
- Water Quality Analyses

Please note that the Deed of Easement included with this submittal has been executed between the National Park Service and Dare County, but has yet to be recorded by the Office of the Register of Deeds. The County is working on this issue and we will forward a "recorded" deed to you upon receipt.

An Application for Approval of Engineering Plans and Specifications for this project was received by NCDENR on January 9, 2004 (Tracking No. 04-00061) and pulled for review on March 4, 2004. The referenced application included Production Wells Wilbur, Orville, 15, and



Harry F. Bailey
March 23, 2005
Page 2

17. We are requesting authorization to finish all construction associated with Production Well Orville.

It is our professional opinion, based upon our review of the water quality and hydrogeologic characteristics of this new well, that the NCDENR should be able to authorize the construction of the permanent facility.

Thank you for your attention and assistance to this critical project for the County. If you have any questions or I can be of further assistance, please do not hesitate to call.

Sincerely,

A handwritten signature in black ink, appearing to read 'G. St. John'.

Gary A. St. John, P.E., DEE
Associate
Camp Dresser & McKee Inc.

cc: Kenneth C. Flatt - Dare County Water
W. Scott Manahan - CDM

Production Well Orville

Well Completion Data

Table of Contents

Section 1: Signed Well Drillers Log

Section 2: Well Yield and Drawdown Report

Section 3: TDH and Pump Head Calculations

Section 4: Engineer's Well Construction Verification

Section 5: Well Site Deed/Plat

Section 6: Water Quality Analyses

WELL CONSTRUCTION RECORD

North Carolina - Department of Environment and Natural Resources - Division of Water Quality - Groundwater Section

WELL CONTRACTOR (INDIVIDUAL) NAME (print) Edward A. Jackson CERTIFICATION # 2426

WELL CONTRACTOR COMPANY NAME A.C. Schultes of Carolina, Inc. PHONE # (910) 285-7465

STATE WELL CONSTRUCTION PERMIT # WS0700769 (if applicable) ASSOCIATED WQ PERMIT # _____ (if applicable)

1 WELL USE (Check Applicable Box): Residential Municipal/Public Industrial Agricultural
 Monitoring Recovery Heat Pump Water Injection Other If Other, List Use _____

2 WELL LOCATION:
 Nearest Town: Kill Devil Hills County Dare
1000 Colington Road (Orville Site)
 (Street Name, Numbers, Community, Subdivision, Lot No., Zip Code)
 Topographic/Land setting
 Ridge Slope Valley Flat
 (check appropriate box)
 Latitude/longitude of well location

 (degrees/minutes/seconds)

3 OWNER: Dare County Water Department
 Address Mustain Drive

 (Street or Route No.)
Kill Devil Hills, NC

 City or Town State Zip Code

Latitude/longitude source: GPS Topographic map
 (check box)

Area code - Phone number

4 DATE DRILLED October 15, 2004

5 TOTAL DEPTH: 410

6 DOES WELL REPLACE EXISTING WELL? YES NO

7 STATIC WATER LEVEL Below Top of Casing: 20 FT.
 (Use "+" if Above Top of Casing)

8 TOP OF CASING IS +3 FT. Above Land Surface *

*Top of casing terminate at/or below land surface requires a variance in accordance with 15A NCAC 2C.0118.

YIELD (gpm): 600 METHOD OF TEST Pump

WATER ZONES (depth) 295 - 405

DEPTH		DRILLING LOG
From	To	Formation Description
SEE ATTACHED		

LOCATION SKETCH

Show direction and distance in miles from at least two State Roads or County Roads. Include the road numbers and common road names.

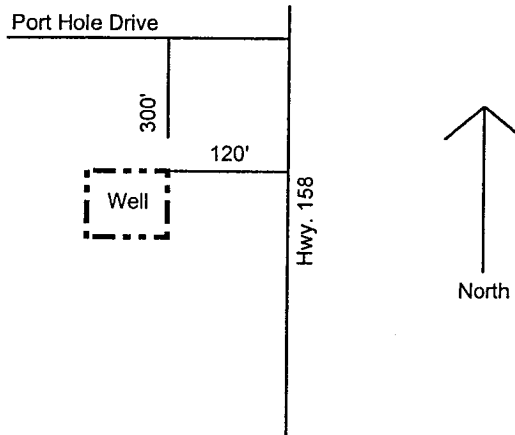

11 DISINFECTION: Type Chlorine Amount 20 # HTH

12 CASING:

From	To	Depth	Diameter	Thickness or Weight/Ft.	Material
From <u>+3</u>	To <u>100</u>	Ft	<u>20"</u>	<u>0.250</u>	<u>Steel</u>
From <u>+3</u>	To <u>295</u>	Ft	<u>12"</u>	<u>0.750</u>	<u>SDR 17 PVC</u>
From <u>405</u>	To <u>410</u>	Ft	<u>8"</u>	<u>0.375</u>	<u>316 S.S.</u>
From _____	To _____	Ft	_____	_____	_____
From _____	To _____	Ft	_____	_____	_____

13 GROUT:

From	To	Depth	Material	Method
From <u>0</u>	To <u>100</u>	Ft	<u>Cement</u>	<u>Tremmie</u>
From <u>0</u>	To <u>295</u>	Ft	<u>Cement</u>	<u>Tremmie</u>

14 SCREEN:

From	To	Depth	Diameter	Slot Size	Material
From <u>295</u>	To <u>405</u>	Ft	<u>8</u>	<u>0.025</u>	<u>316 S.S.</u>
From _____	To _____	Ft	_____	_____	_____
From _____	To _____	Ft	_____	_____	_____
From _____	To _____	Ft	_____	_____	_____

15 SAND/GRAVEL PACK:

From	To	Depth	Size	Material
From <u>295</u>	To <u>410</u>	Ft	<u>#2</u>	<u>Southern Products</u>
From _____	To _____	Ft	_____	_____

16 REMARKS: _____

HEREBY CERTIFY THAT THIS WELL WAS CONSTRUCTED IN ACCORDANCE WITH 15A NCAC 2C, WELL CONSTRUCTION STANDARDS, AND THAT A COPY OF THIS RECORD HAS BEEN PROVIDED TO THE WELL OWNER

Edward A. Jackson
 SIGNATURE OF PERSON CONSTRUCTING THE WELL

November 12, 2004
 DATE

Submit the original to the Division of Water Quality, Groundwater Section, 1636 Mail Service Center - Raleigh, NC 27699-1636
 Phone No. (919) 733-3221, within 30 days.

GW-1 REV. 07/2001

SAND ANALYSIS A.C. SCHULTES, INC.

Town Dare County State North Carolina Date: 9/22/04
 From Well of _____ Orville
 Remarks DITCH SAMPLES
300 - 310

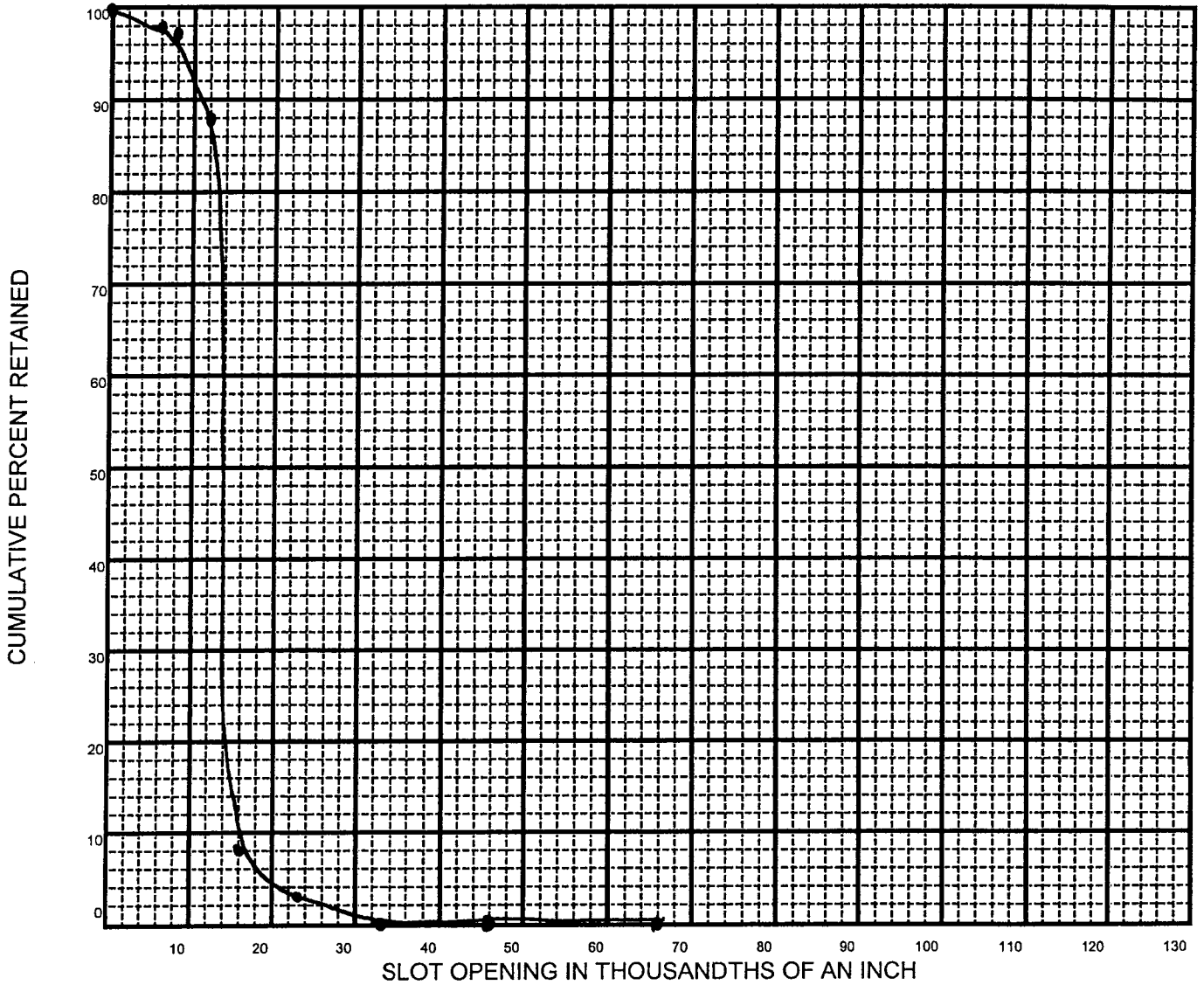

SIEVE OPENING	CUMULATIVE PERCENT RETAINED
0.066	0
0.046	0
0.039	
0.033	0
0.023	3
0.016	8
0.012	88
0.008	97
0.006	98
PAN	100
SCREEN SLOT	

NOTES: _____

SLOT OPENING RECOMMENDED: 0.030

RECOMMENDED SCREEN: DIA: _____ IN. LENGTH _____ FT.

BY: Randy Hudson

SO MANY CONSIDERATION ENTER INTO THE MAKING OF A GOOD WELL THAT WHILE WE BELIEVE SLOT SIZES FURNISHED OR RECOMMENDED FROM SAND SAMPLES ARE CORRECT WE ASSUME NO RESPONSIBILITY FOR THE SUCCESSFUL OPERATION OF JOHNSON WELL SCREENS

SAND ANALYSIS A.C. SCHULTES, INC.

Town Dare County State North Carolina Date: 9/22/04
 From Well of _____
 Remarks DITCH SAMPLES
310 - 320

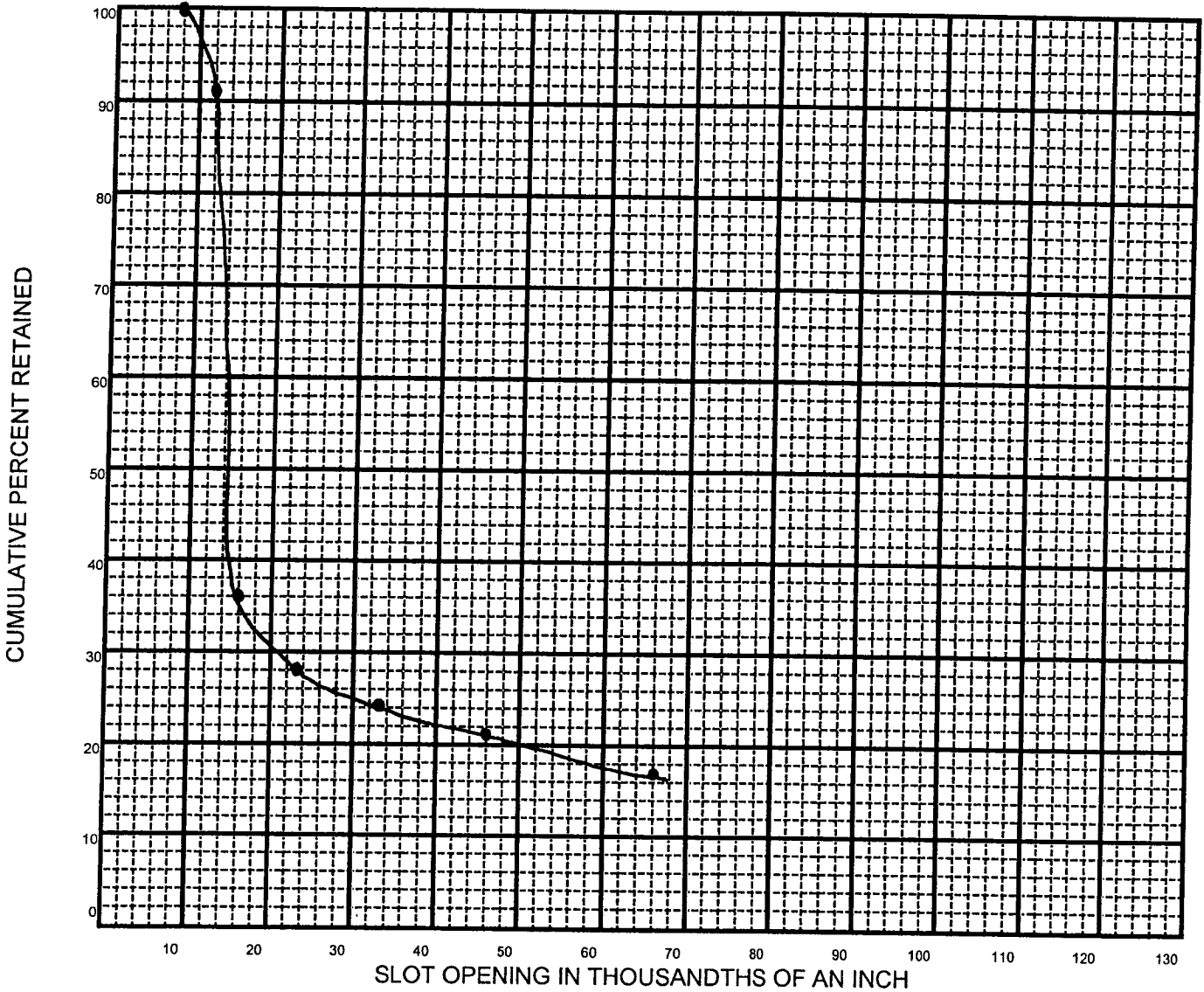

SIEVE OPENING	CUMULATIVE PERCENT RETAINED		
0.066	17		
0.046	21		
0.039			
0.033	24		
0.023	28		
0.016	36		
0.012	91		
0.008	100		
0.006			
PAN			
SCREEN SLOT			

NOTES: _____

SLOT OPENING RECOMMENDED: 0.030

RECOMMENDED SCREEN: DIA: _____ IN. LENGTH _____ FT.

BY: Randy Hudson

SO MANY CONSIDERATION ENTER INTO THE MAKING OF A GOOD WELL THAT WHILE WE BELIEVE SLOT SIZES FURNISHED OR RECOMMENDED FROM SAND SAMPLES ARE CORRECT WE ASSUME NO RESPONSIBILITY FOR THE SUCCESSFUL OPERATION OF JOHNSON WELL SCREENS

SAND ANALYSIS

A.C. SCHULTES, INC.

Town Dare County State North Carolina Date: 9/22/04
 From Well of _____
 Remarks DITCH SAMPLES
320 - 330

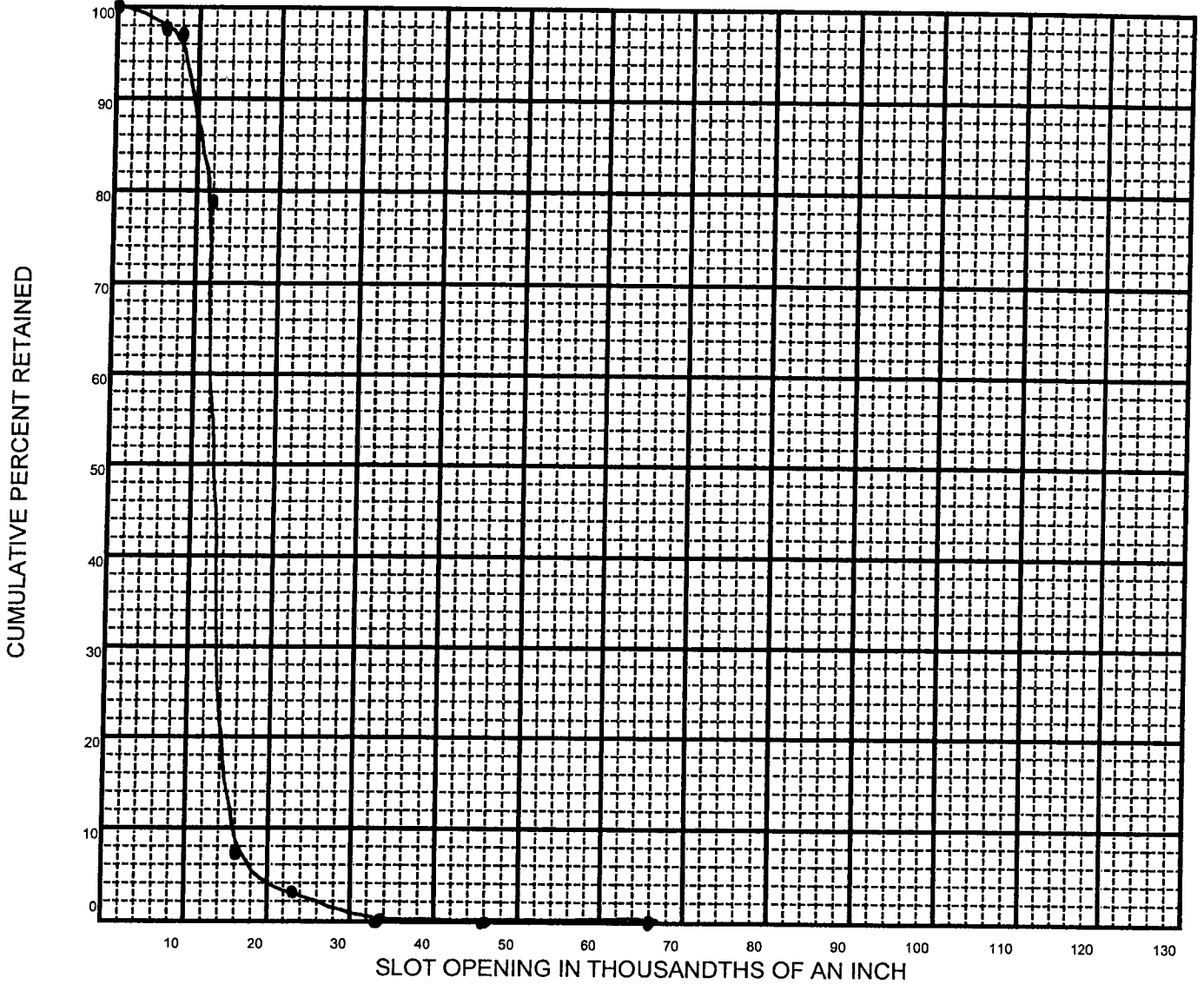

SIEVE OPENING	CUMULATIVE PERCENT RETAINED	
0.066	0	
0.046	0	
0.039		
0.033	0	
0.023	3	
0.016	7	
0.012	79	
0.008	97	
0.006	98	
PAN	100	
SCREEN SLOT		

NOTES: _____

SLOT OPENING RECOMMENDED: 0.030

RECOMMENDED SCREEN: DIA: _____ IN. LENGTH _____ FT.

BY: Randy Hudson

SO MANY CONSIDERATION ENTER INTO THE MAKING OF A GOOD WELL THAT WHILE WE BELIEVE SLOT SIZES FURNISHED OR RECOMMENDED FROM SAND SAMPLES ARE CORRECT WE ASSUME NO RESPONSIBILITY FOR THE SUCCESSFUL OPERATION OF JOHNSON WELL SCREENS

SAND ANALYSIS

A.C. SCHULTES, INC.

Town Dare County State North Carolina Date: 9/22/04
 From Well of _____
 Remarks DITCH SAMPLES
330 - 340

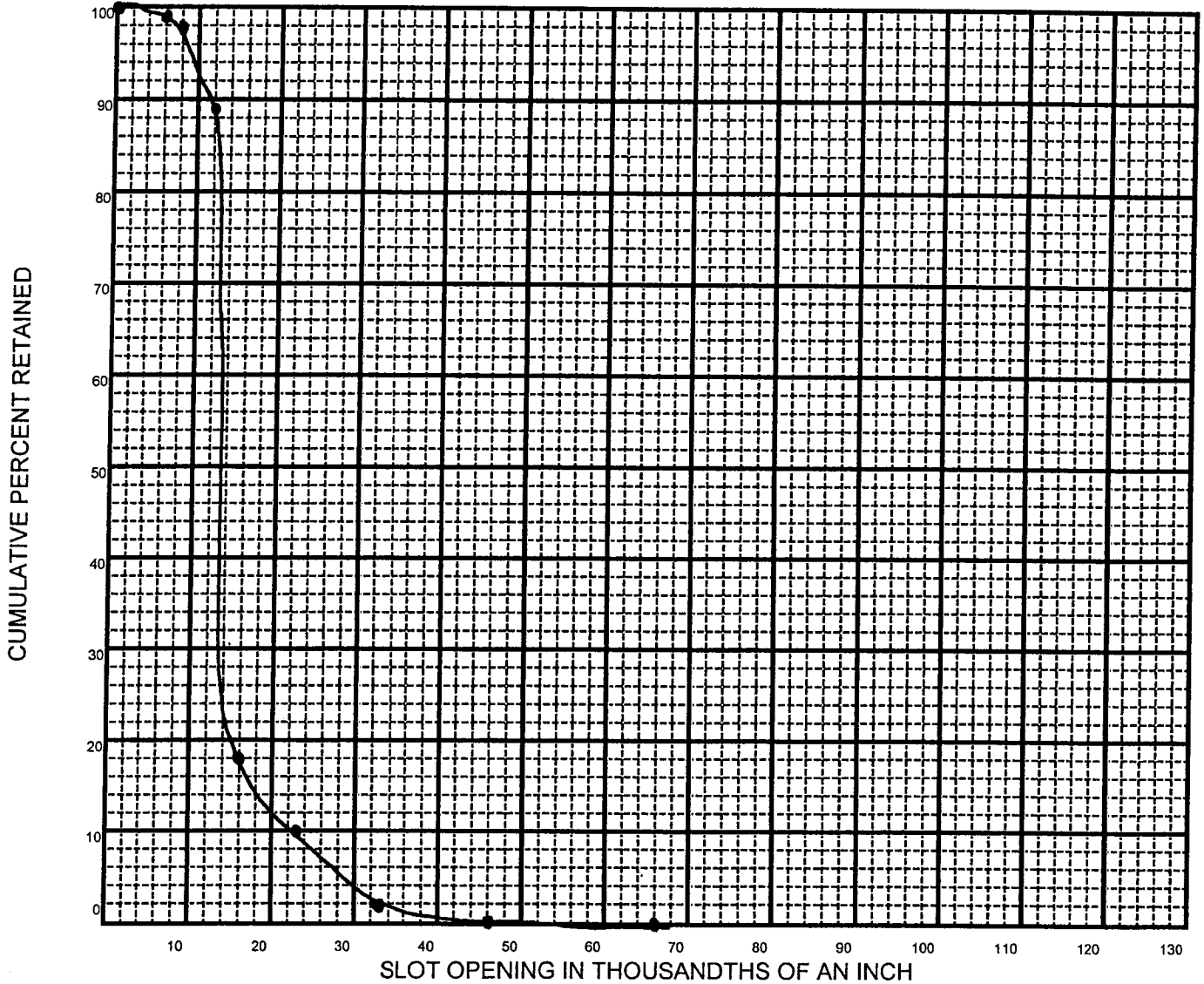

SIEVE OPENING	CUMULATIVE PERCENT RETAINED	
0.066	0	
0.046	0	
0.039		
0.033	2	
0.023	10	
0.016	18	
0.012	89	
0.008	98	
0.006	99	
PAN	100	
SCREEN SLOT		

NOTES: _____

SLOT OPENING RECOMMENDED: 0.030

RECOMMENDED SCREEN: DIA: _____ IN. LENGTH _____ FT.

BY: Randy Hudson

SO MANY CONSIDERATION ENTER INTO THE MAKING OF A GOOD WELL THAT WHILE WE BELIEVE SLOT SIZES FURNISHED OR RECOMMENDED FROM SAND SAMPLES ARE CORRECT WE ASSUME NO RESPONSIBILITY FOR THE SUCCESSFUL OPERATION OF JOHNSON WELL SCREENS

SAND ANALYSIS

A.C. SCHULTES, INC.

Town Dare County State North Carolina Date: 9/22/04
 From Well of _____
 Remarks DITCH SAMPLES
340 - 350

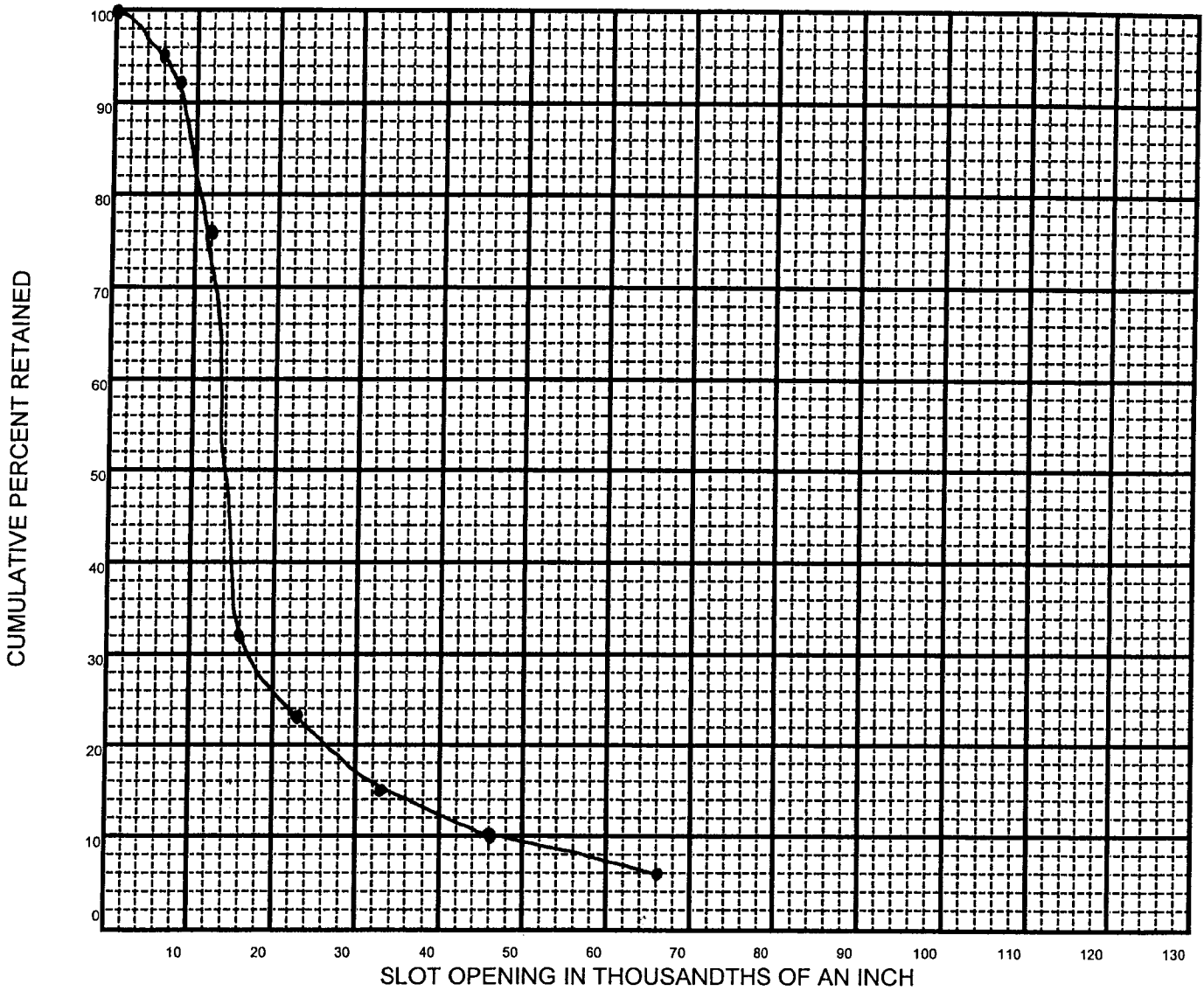

SIEVE OPENING	CUMULATIVE PERCENT RETAINED
0.066	6
0.046	10
0.039	
0.033	15
0.023	23
0.016	32
0.012	76
0.008	92
0.006	95
PAN	100
SCREEN SLOT	

NOTES: _____

SLOT OPENING RECOMMENDED: 0.030

RECOMMENDED SCREEN: DIA: _____ IN. LENGTH _____ FT.

BY: Randy Hudson

SO MANY CONSIDERATION ENTER INTO THE MAKING OF A GOOD WELL THAT WHILE WE BELIEVE SLOT SIZES FURNISHED OR RECOMMENDED FROM SAND SAMPLES ARE CORRECT WE ASSUME NO RESPONSIBILITY FOR THE SUCCESSFUL OPERATION OF JOHNSON WELL SCREENS

SAND ANALYSIS

A.C. SCHULTES, INC.

Town Dare County State North Carolina Date: 9/22/04
 From Well of _____
 Remarks DITCH SAMPLES
350 - 360

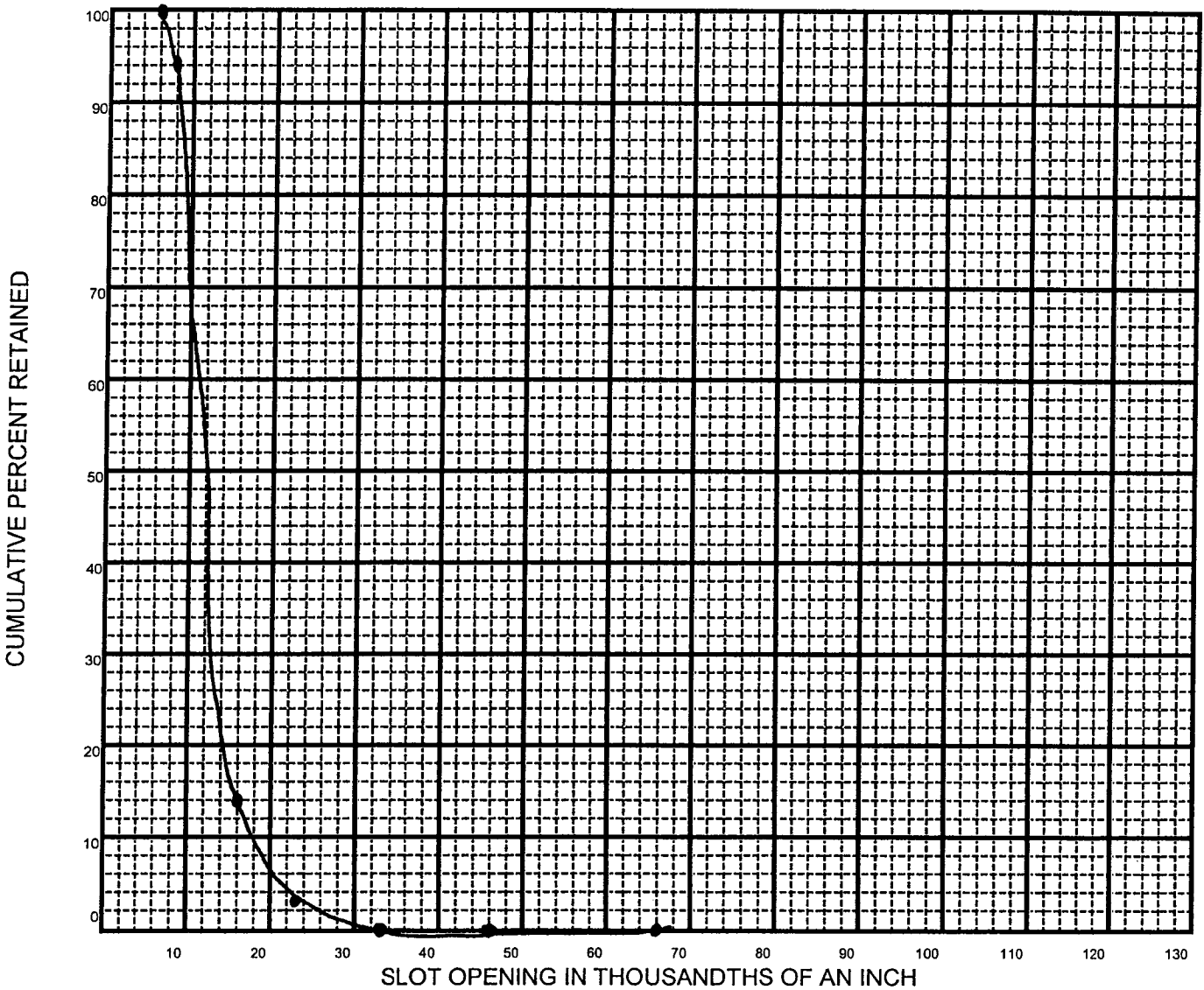

SIEVE OPENING	CUMULATIVE PERCENT RETAINED
0.066	0
0.046	0
0.039	
0.033	0
0.023	3
0.016	14
0.012	94
0.008	100
0.006	
PAN	
SCREEN SLOT	

NOTES: _____

SLOT OPENING RECOMMENDED: 0.030

RECOMMENDED SCREEN: DIA: _____ IN. LENGTH _____ FT.

BY: Randy Hudson

SO MANY CONSIDERATION ENTER INTO THE MAKING OF A GOOD WELL THAT WHILE WE BELIEVE SLOT SIZES FURNISHED OR RECOMMENDED FROM SAND SAMPLES ARE CORRECT WE ASSUME NO RESPONSIBILITY FOR THE SUCCESSFUL OPERATION OF JOHNSON WELL SCREENS

SAND ANALYSIS

A.C. SCHULTES, INC.

Town Dare County State North Carolina Date: 9/22/04
 From Well of _____
 Remarks DITCH SAMPLES
360 - 370

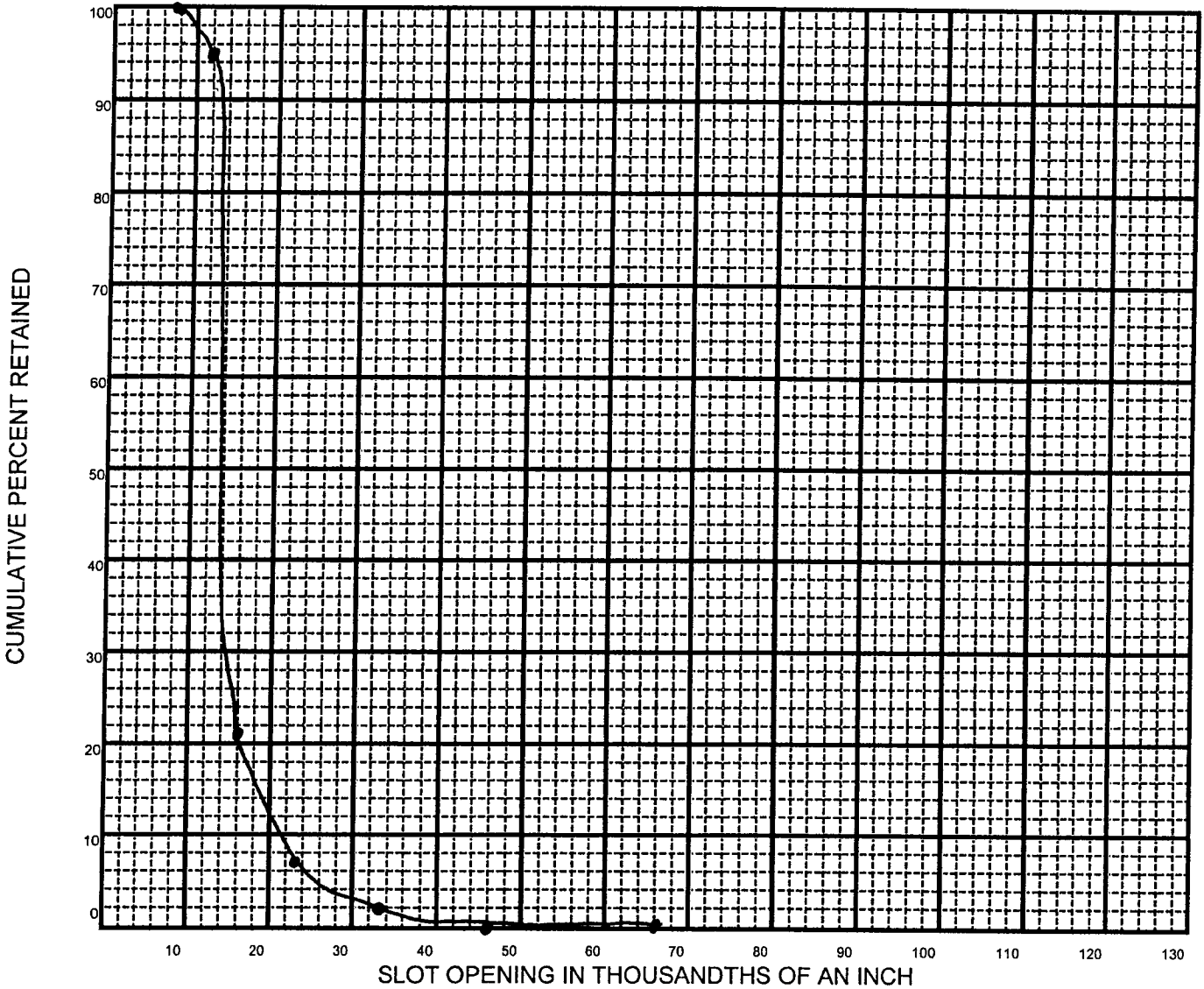

SIEVE OPENING	CUMULATIVE PERCENT RETAINED	
0.066	0	
0.046	0	
0.039		
0.033	2	
0.023	7	
0.016	21	
0.012	95	
0.008	100	
0.006		
PAN		
SCREEN		
SLOT		

NOTES: _____

SLOT OPENING RECOMMENDED: 0.030

RECOMMENDED SCREEN: DIA: _____ IN. LENGTH _____ FT.

BY: Randy Hudson

SO MANY CONSIDERATION ENTER INTO THE MAKING OF A GOOD WELL THAT WHILE WE BELIEVE SLOT SIZES FURNISHED OR RECOMMENDED FROM SAND SAMPLES ARE CORRECT WE ASSUME NO RESPONSIBILITY FOR THE SUCCESSFUL OPERATION OF JOHNSON WELL SCREENS

SAND ANALYSIS

A.C. SCHULTES, INC.

Town Dare County State North Carolina Date: 9/22/04
 From Well of _____
 Remarks DITCH SAMPLES
370 - 380

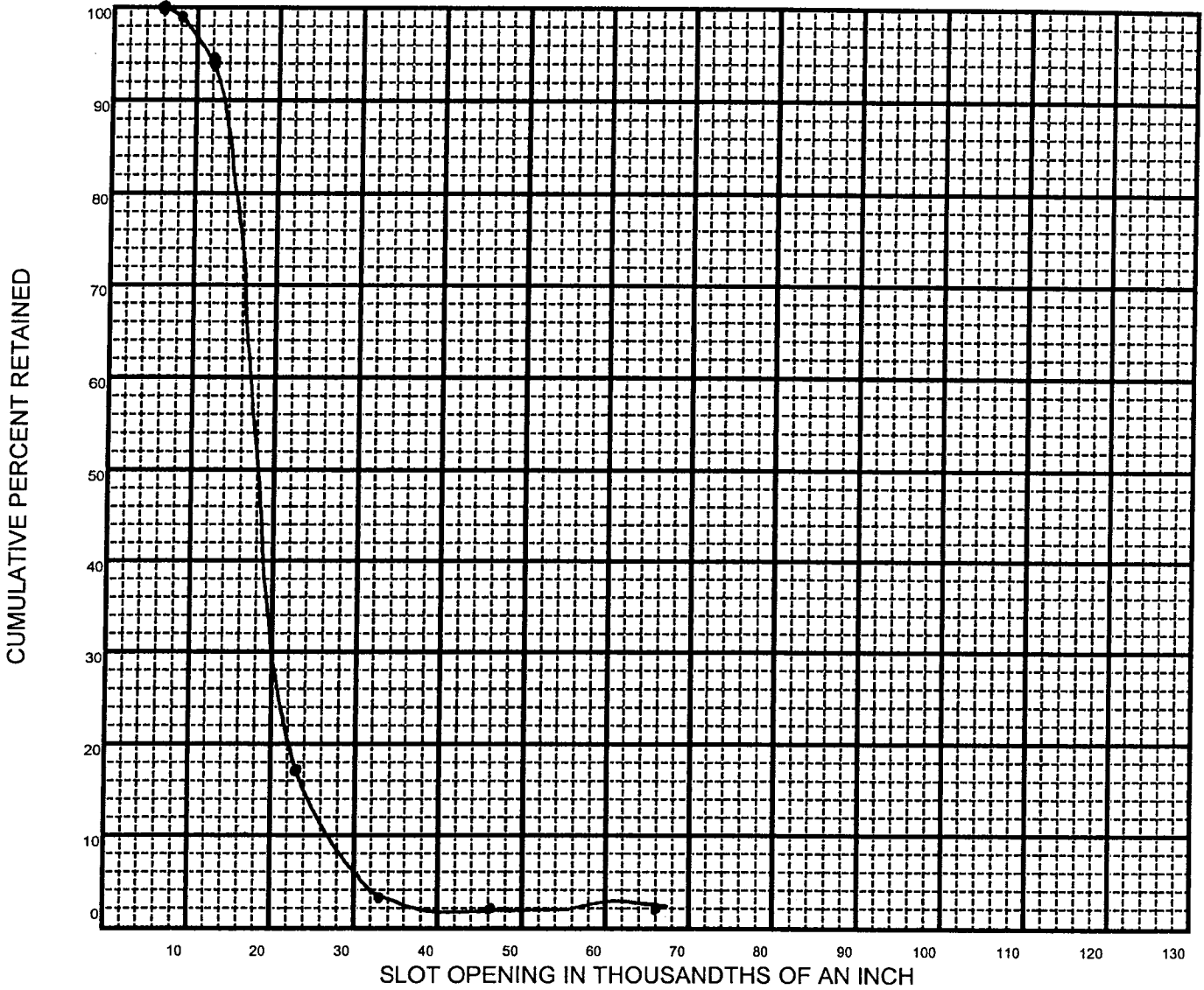

SIEVE OPENING	CUMULATIVE PERCENT RETAINED	
0.066	2	
0.046	2	
0.039		
0.033	3	
0.023	17	
0.016	23	
0.012	94	
0.008	99	
0.006	100	
PAN		
SCREEN SLOT		

NOTES: _____

SLOT OPENING RECOMMENDED: 0.030

RECOMMENDED SCREEN: DIA: _____ IN. LENGTH _____ FT.

BY: Randy Hudson

SO MANY CONSIDERATION ENTER INTO THE MAKING OF A GOOD WELL THAT WHILE WE BELIEVE SLOT SIZES FURNISHED OR RECOMMENDED FROM SAND SAMPLES ARE CORRECT WE ASSUME NO RESPONSIBILITY FOR THE SUCCESSFUL OPERATION OF JOHNSON WELL SCREENS

SAND ANALYSIS

A.C. SCHULTES, INC.

Town Dare County State North Carolina Date: 9/22/04
 From Well of _____
 Remarks DITCH SAMPLES
380 - 390

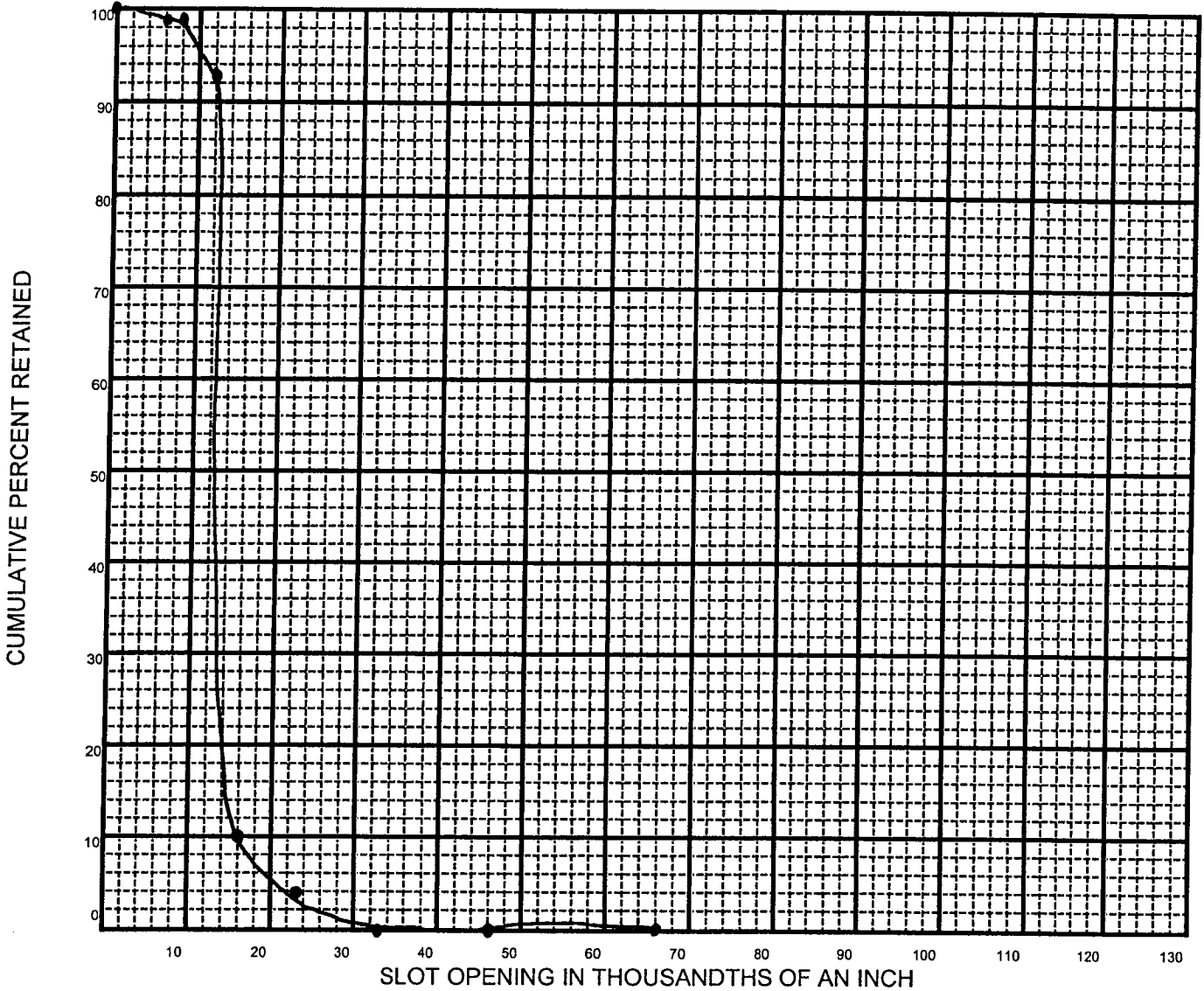

SIEVE OPENING	CUMULATIVE PERCENT RETAINED
0.066	0
0.046	0
0.039	
0.033	0
0.023	4
0.016	10
0.012	93
0.008	99
0.006	99
PAN	100
SCREEN SLOT	

NOTES: _____

SLOT OPENING RECOMMENDED: 0.030

RECOMMENDED SCREEN: DIA: _____ IN. LENGTH _____ FT.

BY: Randy Hudson

SO MANY CONSIDERATION ENTER INTO THE MAKING OF A GOOD WELL THAT WHILE WE BELIEVE SLOT SIZES FURNISHED OR RECOMMENDED FROM SAND SAMPLES ARE CORRECT WE ASSUME NO RESPONSIBILITY FOR THE SUCCESSFUL OPERATION OF JOHNSON WELL SCREENS

SAND ANALYSIS A.C. SCHULTES, INC.

Town Dare County State North Carolina Date: 9/22/04
 From Well of _____ Orville
 Remarks DITCH SAMPLES
390 - 400

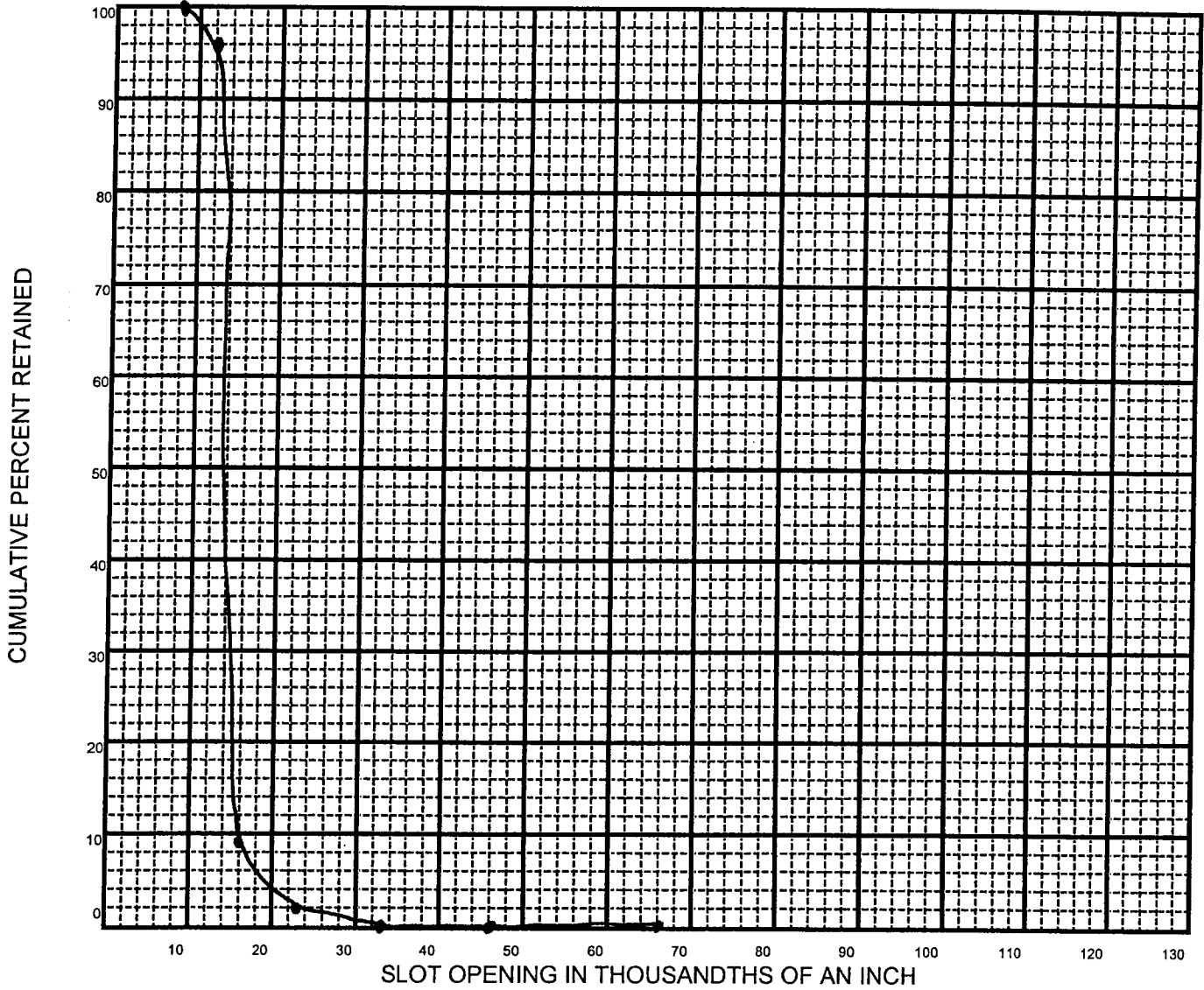

SIEVE OPENING	CUMULATIVE PERCENT RETAINED	
0.066	0	
0.046	0	
0.039		
0.033	0	
0.023	2	
0.016	9	
0.012	96	
0.008	100	
0.006		
PAN		
SCREEN SLOT		

NOTES: _____

SLOT OPENING RECOMMENDED: 0.030

RECOMMENDED SCREEN: DIA: _____ IN. LENGTH _____ FT.

BY: Randy Hudson

SO MANY CONSIDERATION ENTER INTO THE MAKING OF A GOOD WELL THAT WHILE WE BELIEVE SLOT SIZES FURNISHED OR RECOMMENDED FROM SAND SAMPLES ARE CORRECT WE ASSUME NO RESPONSIBILITY FOR THE SUCCESSFUL OPERATION OF JOHNSON WELL SCREENS

SAND ANALYSIS A.C. SCHULTES, INC.

Town Dare County State North Carolina Date: 9/22/04
 From Well of _____
 Remarks DITCH SAMPLES
400 - 410

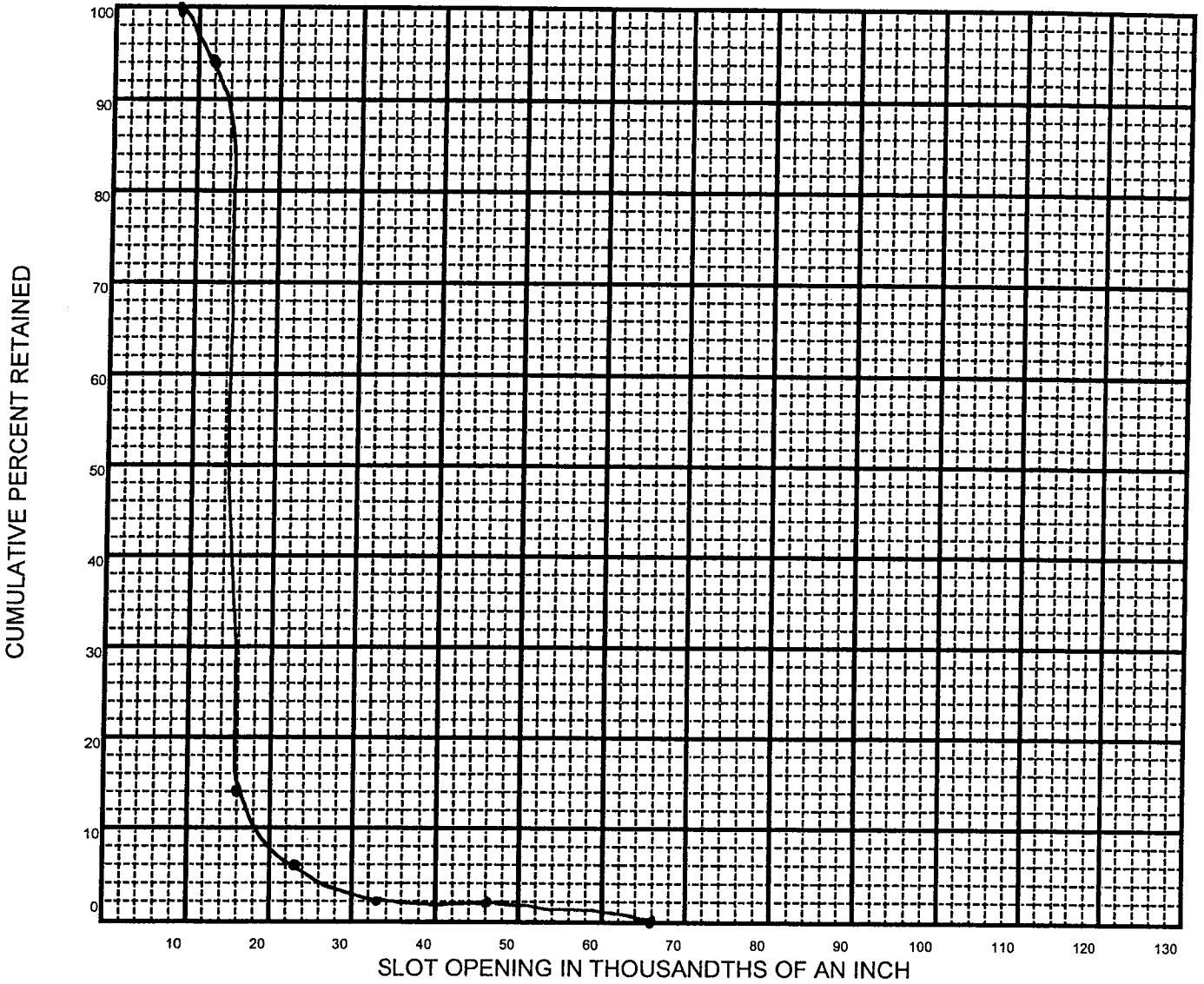

SIEVE OPENING	CUMULATIVE PERCENT RETAINED	
0.066	0	
0.046	2	
0.039		
0.033	2	
0.023	6	
0.016	14	
0.012	94	
0.008	100	
0.006		
PAN		
SCREEN SLOT		

NOTES: _____

SLOT OPENING RECOMMENDED: 0.030

RECOMMENDED SCREEN: DIA: _____ IN. LENGTH _____ FT.

BY: Randy Hudson

SO MANY CONSIDERATION ENTER INTO THE MAKING OF A GOOD WELL THAT WHILE WE BELIEVE SLOT SIZES FURNISHED OR RECOMMENDED FROM SAND SAMPLES ARE CORRECT WE ASSUME NO RESPONSIBILITY FOR THE SUCCESSFUL OPERATION OF JOHNSON WELL SCREENS

SAND ANALYSIS

A.C. SCHULTES, INC.

Town Dare County State North Carolina Date: 9/22/04
 From Well of _____
 Remarks DITCH SAMPLES
410 - 420

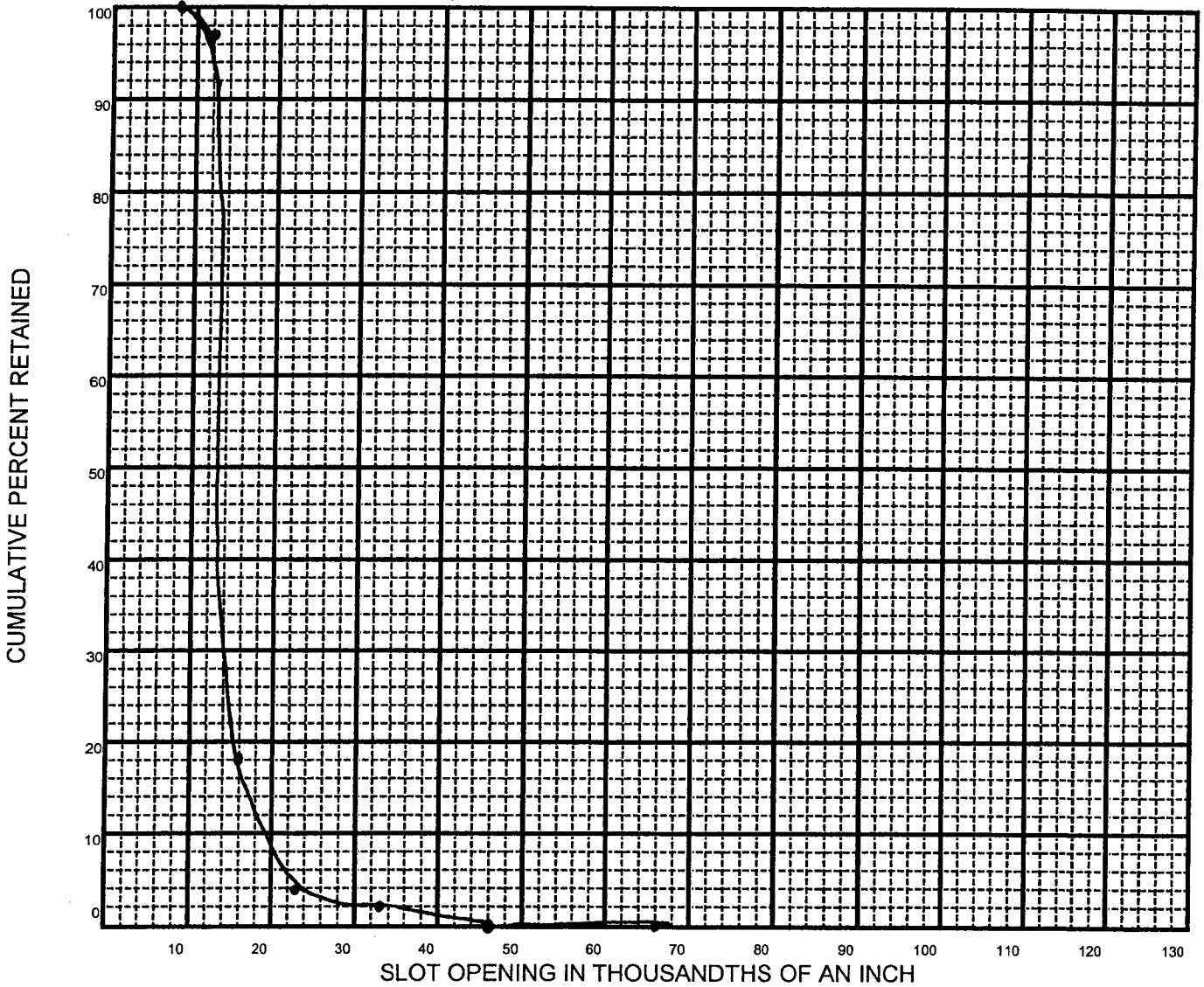

SIEVE OPENING	CUMULATIVE PERCENT RETAINED	
0.066	0	
0.046	0	
0.039		
0.033	2	
0.023	4	
0.016	18	
0.012	97	
0.008	100	
0.006		
PAN		
SCREEN SLOT		

NOTES: _____

SLOT OPENING RECOMMENDED: 0.030

RECOMMENDED SCREEN: DIA: _____ IN. LENGTH _____ FT.

BY: Randy Hudson

SO MANY CONSIDERATION ENTER INTO THE MAKING OF A GOOD WELL THAT WHILE WE BELIEVE SLOT SIZES FURNISHED OR RECOMMENDED FROM SAND SAMPLES ARE CORRECT WE ASSUME NO RESPONSIBILITY FOR THE SUCCESSFUL OPERATION OF JOHNSON WELL SCREENS

SAND ANALYSIS

A.C. SCHULTES, INC.

Town Dare County State North Carolina Date: 9/22/04
 From Well of _____
 Remarks Orville
DITCH SAMPLES
420 - 430

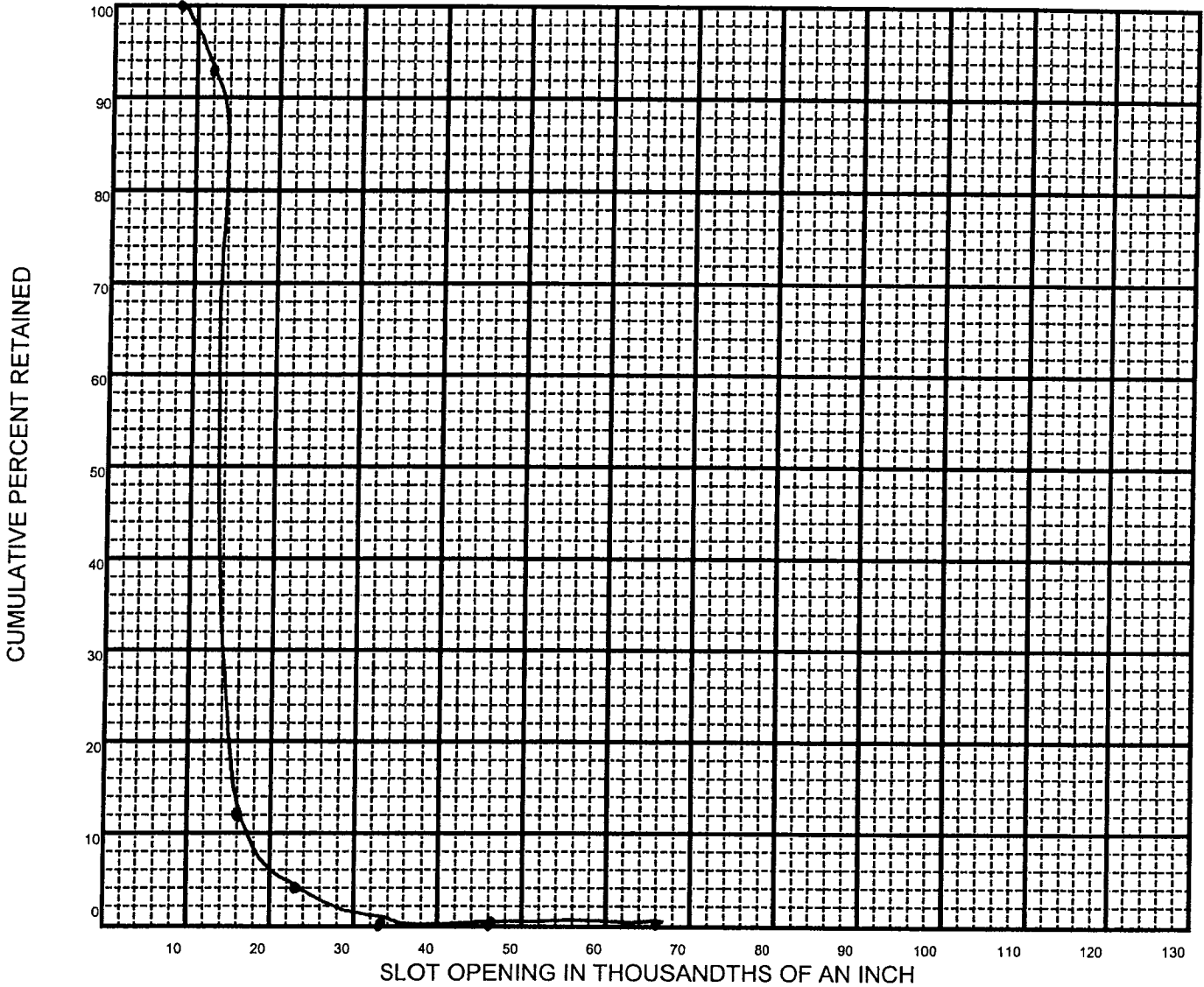

SIEVE OPENING	CUMULATIVE PERCENT RETAINED	
0.066	0	
0.046	0	
0.039		
0.033	0	
0.023	4	
0.016	12	
0.012	93	
0.008	100	
0.006		
PAN		
SCREEN SLOT		

NOTES: _____

SLOT OPENING RECOMMENDED: 0.030

RECOMMENDED SCREEN: DIA: _____ IN. LENGTH _____ FT.

BY: Randy Hudson

SO MANY CONSIDERATION ENTER INTO THE MAKING OF A GOOD WELL THAT WHILE WE BELIEVE SLOT SIZES FURNISHED OR RECOMMENDED FROM SAND SAMPLES ARE CORRECT WE ASSUME NO RESPONSIBILITY FOR THE SUCCESSFUL OPERATION OF JOHNSON WELL SCREENS

COMPANYAC Schultes of Carolina

Location: 158 Kill Devil Hills (36 01.468N, 75 40.090W)

Well Orville

OTHER SERVICES

Date 9-21-04

BH Fluid Bentonite

Casing steel casing to 20-ft

File Name Dare Orville

Depth Driller 430 ft

Depth Logger 430 ft

Logged by: Magette Well and Pump

Witness: A. Jackson (driller)

Gamma	Depth	R8
0 CPS SP	100 1ft:240ft	0 Ohm-m R16 50
-100 mV Current	100	0 Ohm-m R32 50
0 mA SPR	200	0 Ohm-m R64 50
10 ohm	70	0 Ohm-m 50

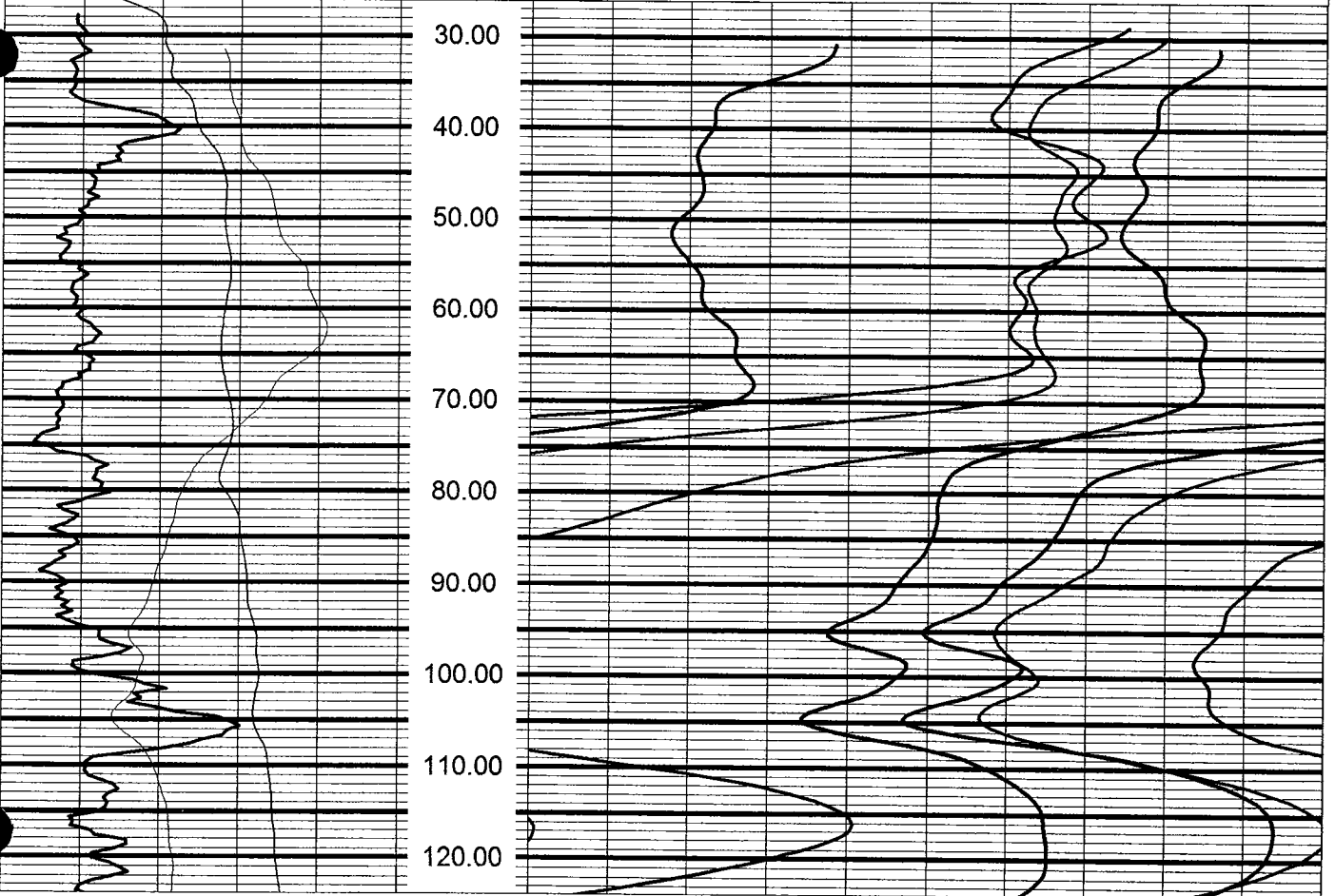

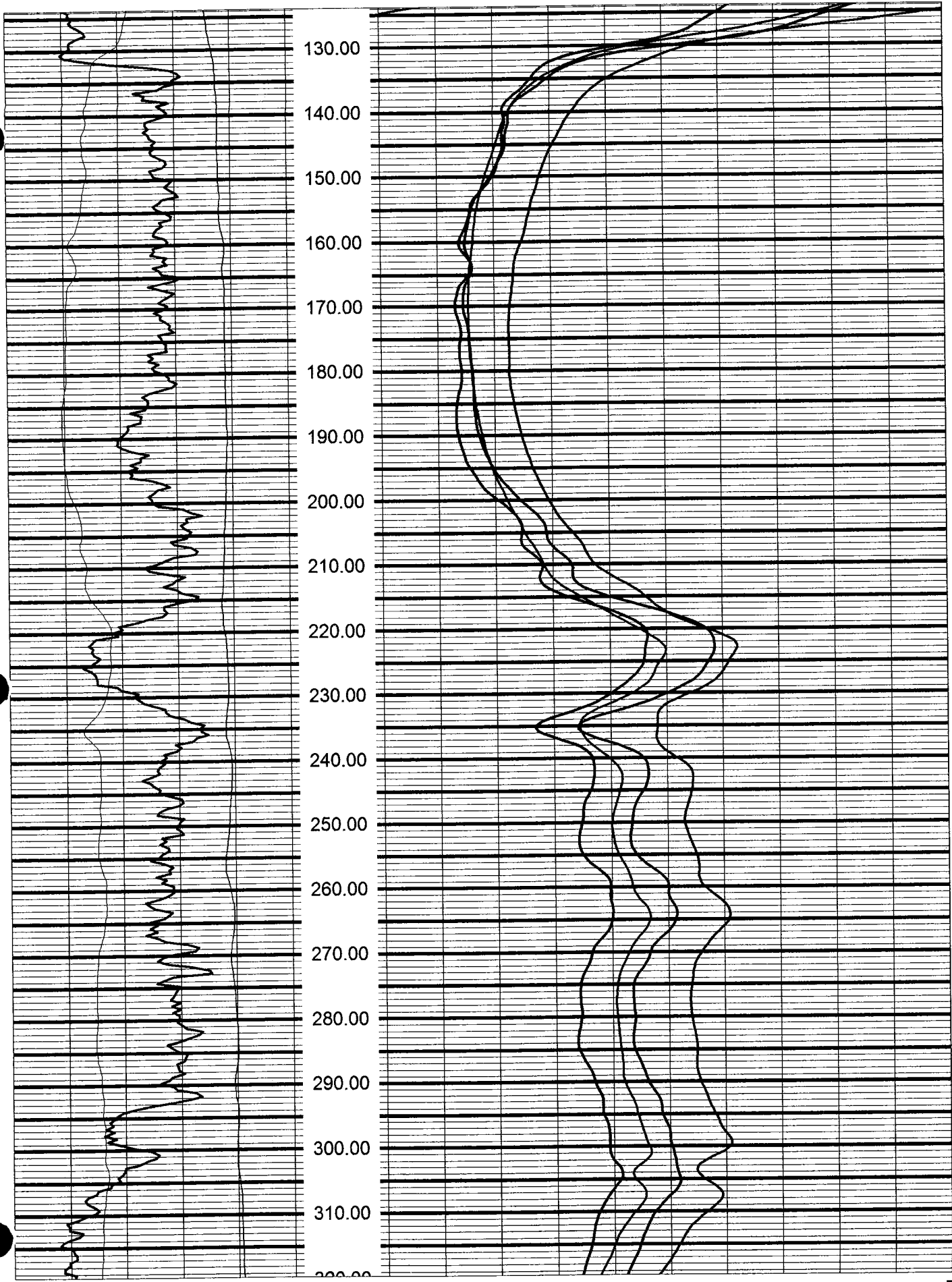

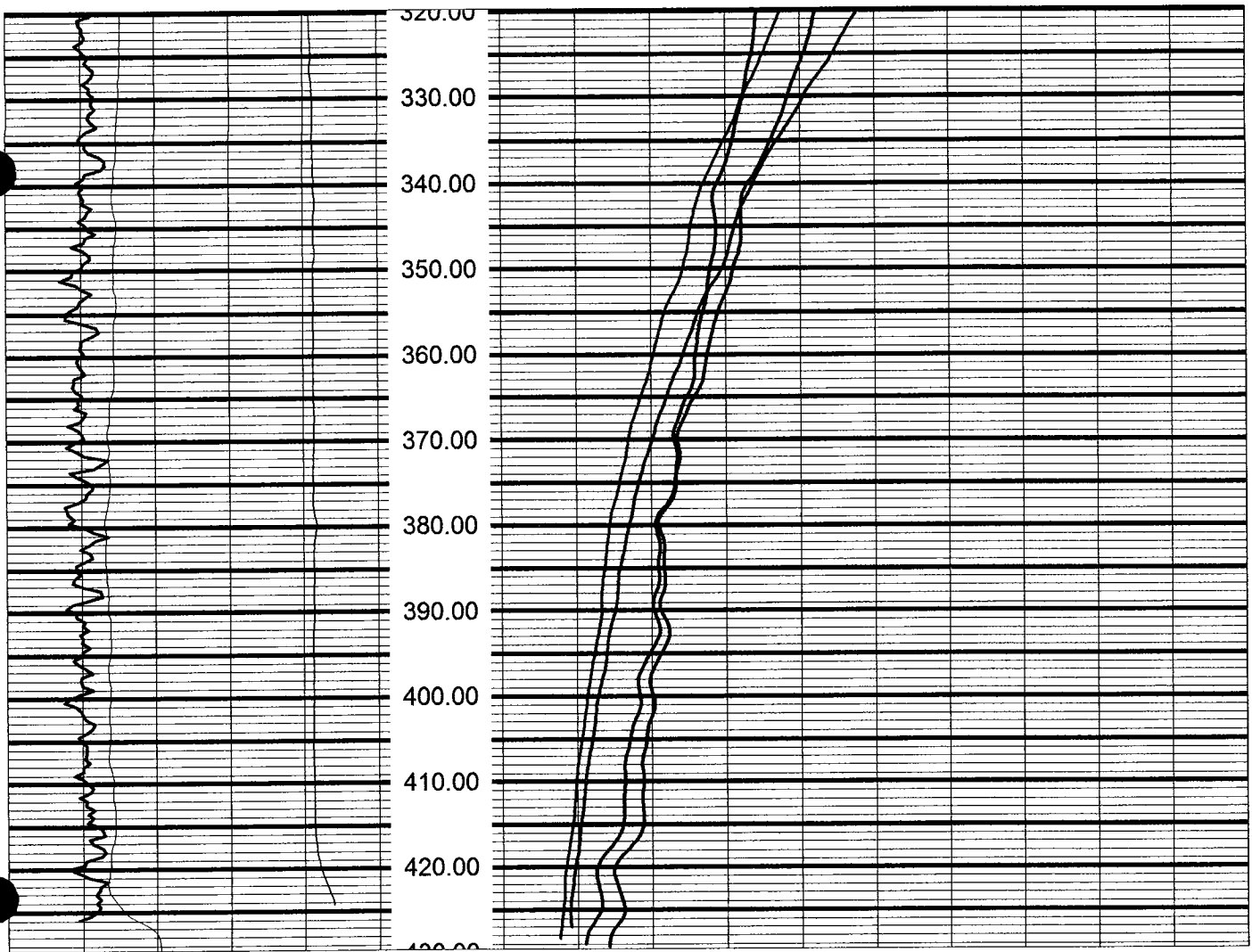

Well Yield and Drawdown Report

Production Well Orville

Submitted By:

Mathew F. Colone
Mathew F. Colone, P.G.

North Carolina Professional Geologist No. 1851

**Step-Drawdown Test Results for Production Well Orville
Kill Devil Hills, North Carolina**

Production Well Orville Test Date: 25 October 2004 Recorded By: A.C. Schultes Static Water Level: 18.25' Below Top of Casing (btoc)					
Pumping Rate (GPM)	Time (minutes)	Water Level (btoc)	Drawdown (feet)	Specific Capacity (gpm/ft)	Comments
400	0	18.25	0.000	34.0	
	5	29.29	11.040		
	10	29.12	10.871		
	20	29.51	11.260		
	30	29.74	11.491		
	40	29.27	11.015		
	50	29.45	11.203		
	60	30.02	11.765		
500	0	30.02	11.765	32.4	Chloride = 1200 mg/l Iron = 0.798 mg/l Conductivity = 4400 usec/cm
	5	33.10	14.849		
	10	32.44	14.186		
	20	32.58	14.330		
	30	33.16	14.907		
	40	32.72	14.474		
	50	32.44	14.186		
	60	33.68	15.426		
600	0	33.68	15.426	32.5	
	5	36.73	18.481		
	10	36.95	18.697		
	20	36.63	18.380		
	30	36.89	18.639		
	40	36.67	18.423		
	50	36.83	18.582		
	60	36.69	18.438		
800	0	36.69	18.438	30.5	Chloride = 1200 mg/l Iron = 0.390 mg/l Conductivity = 4410 usec/cm
	5	44.60	26.348		
	10	44.47	26.219		
	20	44.83	26.579		
	30	44.47	26.219		
	40	44.05	25.801		
	50	44.48	26.233		
	60	44.50	26.248		
1000	0	44.50	26.248	29.2	Chloride = 1250 mg/l Iron = 0.261 mg/l Conductivity = 4170 usec/cm
	5	53.03	34.777		
	10	52.88	34.633		
	20	52.96	34.705		
	30	52.67	34.416		
	40	52.85	34.604		
	50	52.91	34.661		
	60	52.55	34.301		

*Measuring Point is Top of Casing (approximately 3 feet above land surface).

All water quality data collected at end of step.

PUMPING WELL ORVILLE 5 HOUR STEP TEST RESULTS

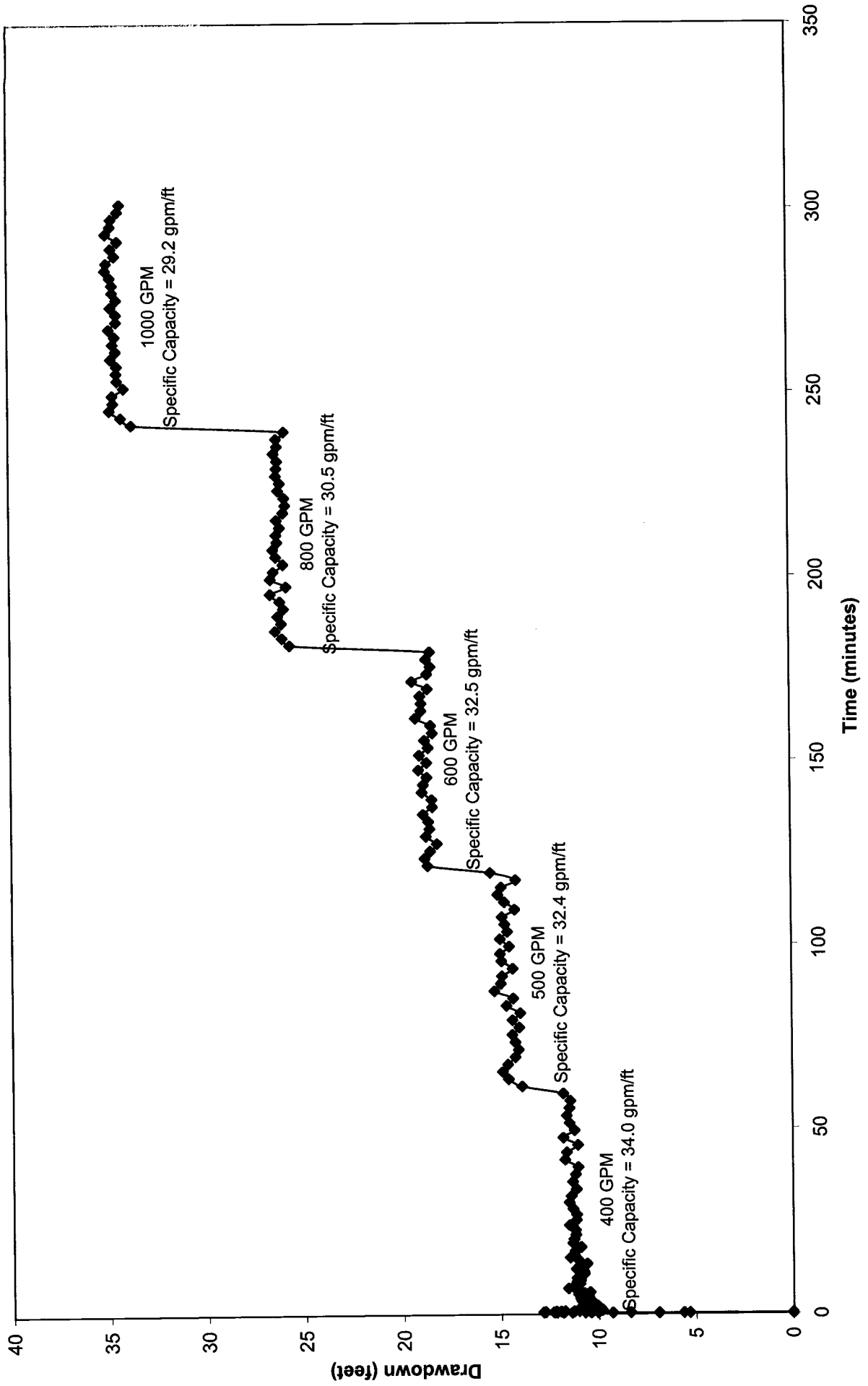

Dare County Water Department
Graph Showing Drawdown in Pumping Well Orville
While Pumping at Rates of 400, 500, 600, 800, and 1000 GPM

**48 Hour Constant Rate Pump Test at Production Well Orville
Kill Devil Hills, North Carolina**

Production Well Orville Begin Test Date: 26 October 2004 (1159 hrs) End Test Date: 28 October 2004 (1204 hrs) Pumping Rate: 600 GPM Recorded By: A.C. Schultes Static Water Level: 18.9' Below Top of Casing (btoc)				
Pumping Rate (GPM)	Time (Minutes)	Water Level (btoc)	Drawdown (feet)	Specific Capacity (gpm/ft)
600	0	18.9	0	
	0.5	19.07	0.166	
	1	34.01	15.107	
	5	35.64	16.739	
	10	36.18	17.283	
	15	36.36	17.456	
	20	36.49	17.586	34.1
	25	36.80	17.903	
	30	36.66	17.759	
	35	36.77	17.874	
	40	37.25	18.350	
	45	37.19	18.292	
	50	37.16	18.263	
	55	36.95	18.047	
	60	37.31	18.407	
	70	37.48	18.580	32.3
	80	37.38	18.480	
	90	37.60	18.696	
	100	37.83	18.926	
	113	37.74	18.840	
	125	37.61	18.710	
	141	37.64	18.739	
	155	37.83	18.926	
	179	37.78	18.883	31.8
	209	36.79	17.889	
	239	37.35	18.451	
	269	37.94	19.042	
	299	37.38	18.480	
	329	37.60	18.696	
	359	37.25	18.350	
	399	37.35	18.451	
	469	37.31	18.407	32.6
	559	37.45	18.552	
	689	38.22	19.315	
	759	38.23	19.330	
	1029	38.49	19.589	
	1089	38.13	19.229	
	1149	37.93	19.027	
	1209	37.74	18.840	
	1269	37.83	18.926	31.7
	1329	38.17	19.272	
	1389	38.39	19.488	
	1449	38.73	19.834	
	1569	39.18	20.281	
	1689	38.48	19.575	
	1809	38.48	19.575	
	1929	38.92	20.021	
	2049	37.91	19.013	31.6
	2169	39.15	20.252	
	2289	38.75	19.849	
	2409	38.94	20.036	
	2529	38.66	19.762	
	2649	38.60	19.704	
	2769	38.58	19.676	
	2883	38.40	19.503	30.8

*Measuring point is Top of Casing approximately 3 feet above land surface.

PRODUCTION WELL ORVILLE
48 HOUR CONSTANT RATE TEST RESULTS

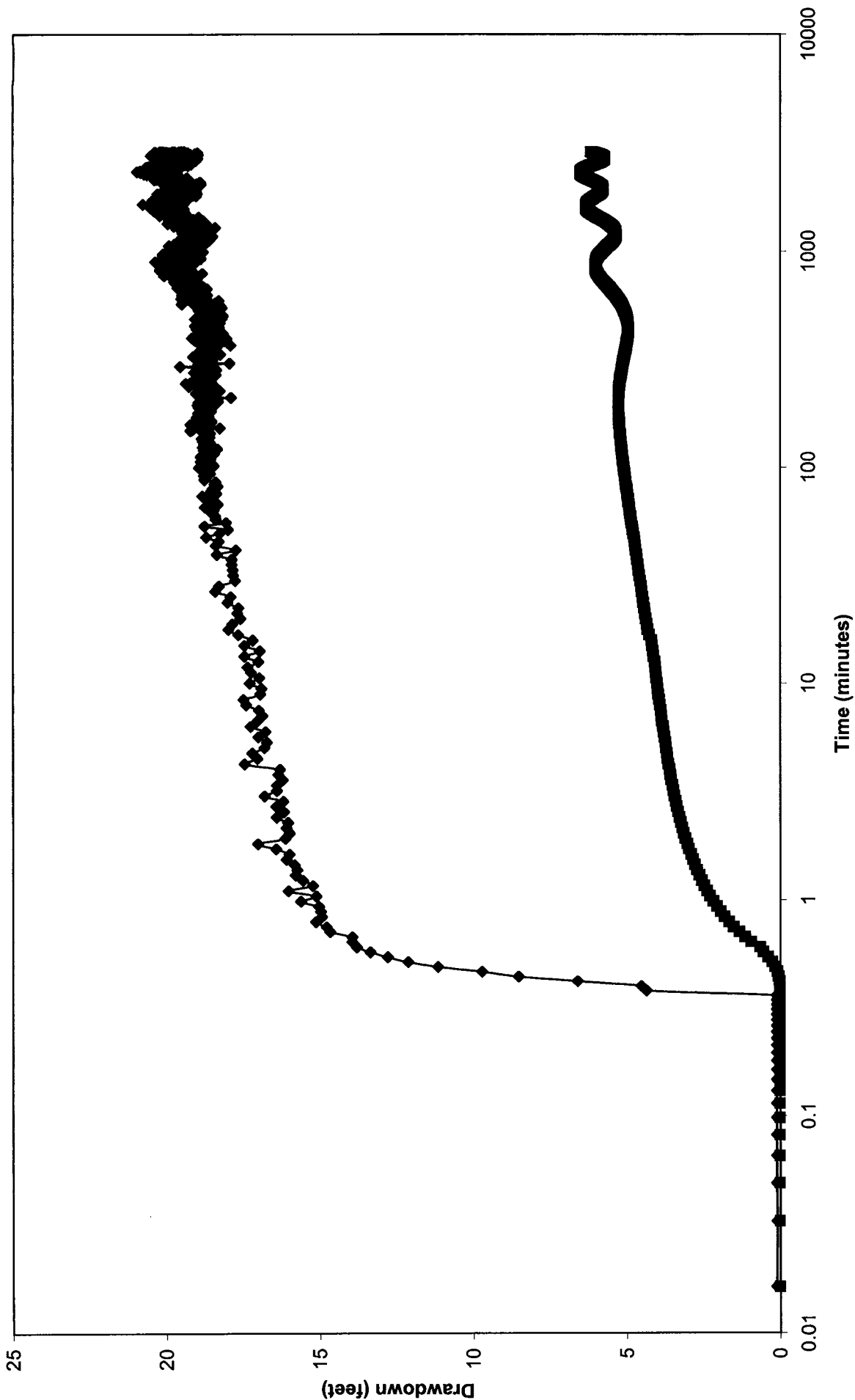

—◆— PW Orville —■— TW Orville

Dare County Water Department
Semi-Log Graph Showing Drawdown vs. Time in Production Well Orville
While Pumping at 600 GPM

**Recovery Test Results for Production Well Orville
Kill Devil Hills, North Carolina**

Production Well Orville		
Begin Test Date: 28 October 2004 (1204 hrs)		
End Test Date: 29 October 2004 (0704 hrs)		
Recorded By: A.C. Schultes		
Static Water Level: 18.9' Below Top of Casing (btoc)		
Time (Minutes)	Water Level (btoc)	Recovery (feet)
0	38.58	19.68
1	22.65	3.75
5	21.12	2.22
10	20.99	2.09
15	20.88	1.98
20	20.78	1.88
25	20.70	1.80
30	20.66	1.76
35	20.46	1.56
40	20.57	1.67
45	20.54	1.64
50	20.53	1.63
60	20.50	1.60
100	20.44	1.54
150	20.42	1.52
200	20.38	1.48
250	20.24	1.34
300	20.13	1.23
350	19.95	1.05
400	19.77	0.87
450	19.58	0.68
500	19.45	0.55
550	19.38	0.48
600	19.38	0.48
650	19.41	0.51
700	19.46	0.56
800	19.68	0.78
900	19.74	0.84
1000	19.58	0.68
1100	19.25	0.35
1150	19.06	0.16

*Measuring point is Top of Casing approximately 3 feet above land surface.

PRODUCTION WELL ORVILLE
RECOVERY TEST RESULTS

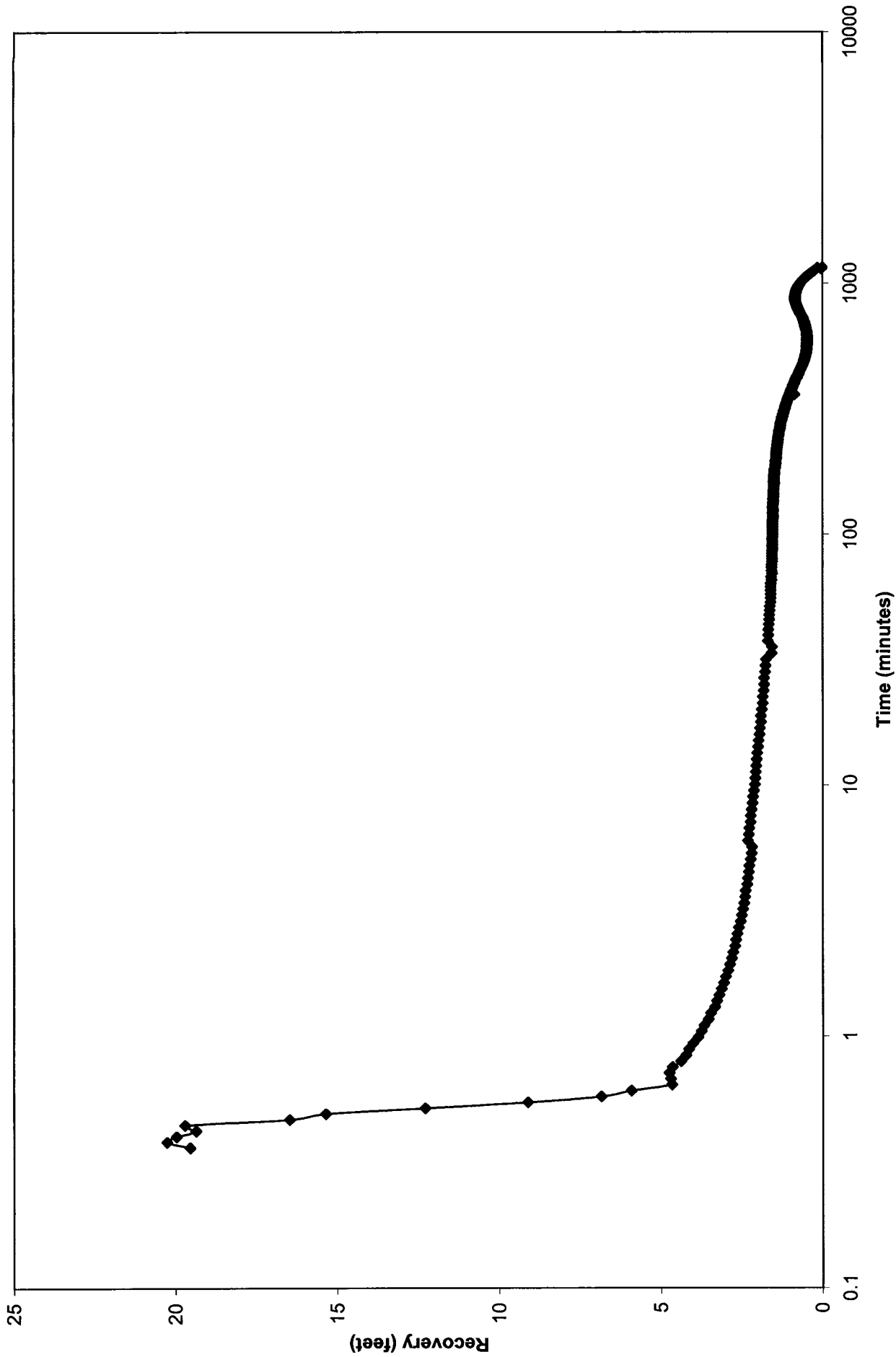

In-Situ Inc. Hermit 3000

Report generated: 11/1/04 7:34:48
Report from file: C:\Win-Situ\Data\SN45674 2004-10-25 162645 DARECO BACKGRD .bin
Data Mgr Version 3.68

Serial number: 45674
Firmware Version 7.10
Unit name: HERMIT 3000

Test name: DARE ORVILLE STEP

Test defined on: 10/21/04 13:10:58
Test started on: 10/25/04 10:04:08
Test stopped on: 10/25/04 15:07:30
Test extracted on: 11/1/04 8:26:43

Data gathered using Logarithmic testing
Maximum time between data points: 2.0000
Number of data samples: 238

TOTAL DATA SAMPLES 238

Channel number [1]

Measurement type: Pressure
Channel name: Probe #1
Linearity: 0.2503
Scale: 99.8402
Offset: -0.1892
Warmup: 50
Specific gravity: 1
Mode: TOC
User-defined reference: 18.9 Feet H2O
Referenced on: channel definition.
Pressure head at reference: 72.602 Feet H2O

Channel number [3]

Measurement type: Pressure
Channel name: Probe #3
Linearity: 0.0175000
Scale: 49.7382000
Offset: -0.2552000
Warmup: 50
Specific gravity: 1.000
Mode: TOC
User-defined reference: 18.25 Feet H2O
Referenced on: channel definition.
Pressure head at reference: 31.748 Feet H2O

Channel number [0]

Measurement type: Barometric Pressure
Channel name: Barometric
Linearity: 0.0000000
Scale: 0.0000000
Offset: 0.0000000
Warmup: 50

Date	Time	ET (min)	Chan[1] Feet H2O	Chan[1] Feet H2O	PW Orville Drawdown (ft)	Chan[3] Feet H2O	Chan[3] Feet H2O
10/25/04	10:04:08	0.0000	-62.029	17.971	0.031	-17.653	17.653
10/25/04	10:04:08	0.0165	-62.058	17.942	0.002	-17.653	17.653
10/25/04	10:04:09	0.0330	-62.058	17.942	0.002	-17.653	17.653
10/25/04	10:04:10	0.0495	-62.058	17.942	0.002	-17.653	17.653
10/25/04	10:04:11	0.0660	-62.058	17.942	0.002	-17.660	17.66
10/25/04	10:04:12	0.0825	-62.058	17.942	0.002	-17.653	17.653
10/25/04	10:04:13	0.0990	-62.058	17.942	0.002	-17.653	17.653
10/25/04	10:04:14	0.1155	-62.043	17.957	0.017	-17.660	17.66
10/25/04	10:04:15	0.1320	-62.058	17.942	0.002	-17.653	17.653
10/25/04	10:04:16	0.1485	-62.043	17.957	0.017	-17.653	17.653
10/25/04	10:04:17	0.1650	-62.043	17.957	0.017	-17.653	17.653
10/25/04	10:04:18	0.1815	-62.058	17.942	0.002	-17.653	17.653
10/25/04	10:04:19	0.1980	-62.043	17.957	0.017	-17.653	17.653
10/25/04	10:04:22	0.2475	-56.738	23.262	5.322	-17.646	17.646
10/25/04	10:04:23	0.2640	-56.436	23.564	5.624	-17.631	17.631
10/25/04	10:04:24	0.2805	-55.153	24.847	6.907	-17.617	17.617
10/25/04	10:04:25	0.2970	-53.697	26.303	8.363	-17.595	17.595
10/25/04	10:04:26	0.3135	-52.760	27.240	9.300	-17.559	17.559
10/25/04	10:04:27	0.3300	-52.010	27.990	10.050	-17.509	17.509
10/25/04	10:04:28	0.3467	-51.650	28.350	10.410	-17.452	17.452
10/25/04	10:04:29	0.3643	-51.347	28.653	10.713	-17.380	17.38
10/25/04	10:04:30	0.3830	-50.684	29.316	11.376	-17.301	17.301
10/25/04	10:04:32	0.4028	-50.223	29.777	11.837	-17.215	17.215
10/25/04	10:04:33	0.4238	-49.906	30.094	12.154	-17.108	17.108
10/25/04	10:04:34	0.4460	-49.791	30.209	12.269	-16.993	16.993
10/25/04	10:04:36	0.4695	-49.892	30.108	12.168	-16.871	16.871
10/25/04	10:04:37	0.4943	-49.214	30.786	12.846	-16.749	16.749
10/25/04	10:04:39	0.5207	-49.733	30.267	12.327	-16.620	16.62
10/25/04	10:04:40	0.5487	-49.906	30.094	12.154	-16.498	16.498
10/25/04	10:04:42	0.5783	-49.315	30.685	12.745	-16.383	16.383
10/25/04	10:04:44	0.6097	-50.122	29.878	11.938	-16.283	16.283
10/25/04	10:04:46	0.6428	-49.848	30.152	12.212	-16.211	16.211
10/25/04	10:04:48	0.6780	-50.310	29.690	11.750	-16.082	16.082
10/25/04	10:04:50	0.7153	-50.785	29.215	11.275	-16.003	16.003
10/25/04	10:04:53	0.7548	-51.045	28.955	11.015	-15.946	15.946
10/25/04	10:04:55	0.7967	-51.549	28.451	10.511	-15.888	15.888
10/25/04	10:04:58	0.8410	-51.405	28.595	10.655	-15.838	15.838
10/25/04	10:05:01	0.8880	-51.765	28.235	10.295	-15.810	15.81
10/25/04	10:05:04	0.9378	-51.794	28.206	10.266	-15.795	15.795
10/25/04	10:05:07	0.9905	-51.693	28.307	10.367	-15.781	15.781
10/25/04	10:05:10	1.0463	-52.227	27.773	9.833	-15.767	15.767
10/25/04	10:05:14	1.1055	-51.996	28.004	10.064	-15.759	15.759
10/25/04	10:05:18	1.1682	-51.967	28.033	10.093	-15.738	15.738
10/25/04	10:05:22	1.2345	-51.607	28.393	10.453	-15.716	15.716
10/25/04	10:05:26	1.3048	-51.463	28.537	10.597	-15.702	15.702
10/25/04	10:05:30	1.3793	-51.780	28.220	10.280	-15.680	15.68
10/25/04	10:05:35	1.4583	-52.097	27.903	9.963	-15.652	15.652
10/25/04	10:05:40	1.5420	-51.117	28.883	10.943	-15.630	15.63
10/25/04	10:05:45	1.6305	-51.708	28.292	10.352	-15.594	15.594
10/25/04	10:05:51	1.7243	-51.549	28.451	10.511	-15.573	15.573
10/25/04	10:05:57	1.8237	-51.693	28.307	10.367	-15.551	15.551
10/25/04	10:06:03	1.9290	-51.794	28.206	10.266	-15.523	15.523
10/25/04	10:06:10	2.0405	-51.996	28.004	10.064	-15.508	15.508

10/25/04	10:06:17	2.1587	-51.737	28.263	10.323	-15.480	15.48
10/25/04	10:06:25	2.2838	-51.477	28.523	10.583	-15.458	15.458
10/25/04	10:06:32	2.4163	-51.780	28.220	10.280	-15.429	15.429
10/25/04	10:06:41	2.5568	-51.492	28.508	10.568	-15.415	15.415
10/25/04	10:06:50	2.7057	-51.708	28.292	10.352	-15.379	15.379
10/25/04	10:06:59	2.8632	-51.290	28.710	10.770	-15.358	15.358
10/25/04	10:07:09	3.0300	-51.232	28.768	10.828	-15.343	15.343
10/25/04	10:07:20	3.2068	-51.708	28.292	10.352	-15.329	15.329
10/25/04	10:07:31	3.3942	-51.174	28.826	10.886	-15.315	15.315
10/25/04	10:07:43	3.5925	-51.347	28.653	10.713	-15.293	15.293
10/25/04	10:07:56	3.8027	-51.362	28.638	10.698	-15.272	15.272
10/25/04	10:08:09	4.0253	-51.117	28.883	10.943	-15.257	15.257
10/25/04	10:08:23	4.2612	-51.218	28.782	10.842	-15.243	15.243
10/25/04	10:08:38	4.5110	-51.520	28.480	10.540	-15.229	15.229
10/25/04	10:08:54	4.7757	-51.492	28.508	10.568	-15.207	15.207
10/25/04	10:09:11	5.0560	-51.016	28.984	11.044	-15.193	15.193
10/25/04	10:09:29	5.3528	-51.333	28.667	10.727	-15.164	15.164
10/25/04	10:09:48	5.6673	-51.607	28.393	10.453	-15.150	15.15
10/25/04	10:10:08	6.0005	-51.088	28.912	10.972	-15.143	15.143
10/25/04	10:10:29	6.3533	-50.886	29.114	11.174	-15.128	15.128
10/25/04	10:10:51	6.7272	-50.497	29.503	11.563	-15.114	15.114
10/25/04	10:11:15	7.1232	-50.756	29.244	11.304	-15.092	15.092
10/25/04	10:11:40	7.5425	-50.929	29.071	11.131	-15.078	15.078
10/25/04	10:12:07	7.9868	-51.088	28.912	10.972	-15.064	15.064
10/25/04	10:12:35	8.4575	-50.929	29.071	11.131	-15.049	15.049
10/25/04	10:13:05	8.9560	-51.131	28.869	10.929	-15.035	15.035
10/25/04	10:13:37	9.4840	-50.944	29.056	11.116	-15.021	15.021
10/25/04	10:14:10	10.0433	-51.189	28.811	10.871	-14.999	14.999
10/25/04	10:14:46	10.6358	-51.319	28.681	10.741	-14.985	14.985
10/25/04	10:15:23	11.2633	-51.290	28.710	10.770	-14.963	14.963
10/25/04	10:16:03	11.9282	-50.915	29.085	11.145	-14.949	14.949
10/25/04	10:16:45	12.6323	-51.117	28.883	10.943	-14.935	14.935
10/25/04	10:17:30	13.3782	-51.463	28.537	10.597	-14.920	14.92
10/25/04	10:18:18	14.1682	-51.059	28.941	11.001	-14.906	14.906
10/25/04	10:19:08	15.0050	-50.598	29.402	11.462	-14.892	14.892
10/25/04	10:20:01	15.8915	-50.800	29.200	11.260	-14.877	14.877
10/25/04	10:20:57	16.8305	-50.857	29.143	11.203	-14.849	14.849
10/25/04	10:21:57	17.8252	-51.160	28.840	10.900	-14.834	14.834
10/25/04	10:23:00	18.8788	-50.742	29.258	11.318	-14.820	14.82
10/25/04	10:24:07	19.9948	-50.800	29.200	11.260	-14.805	14.805
10/25/04	10:25:18	21.1770	-50.901	29.099	11.159	-14.791	14.791
10/25/04	10:26:33	22.4292	-50.886	29.114	11.174	-14.770	14.77
10/25/04	10:27:53	23.7557	-50.569	29.431	11.491	-14.762	14.762
10/25/04	10:29:17	25.1607	-50.929	29.071	11.131	-14.734	14.734
10/25/04	10:30:46	26.6490	-50.944	29.056	11.116	-14.719	14.719
10/25/04	10:32:21	28.2255	-50.771	29.229	11.289	-14.712	14.712
10/25/04	10:34:01	29.8953	-50.569	29.431	11.491	-14.684	14.684
10/25/04	10:35:47	31.6642	-50.684	29.316	11.376	-14.662	14.662
10/25/04	10:37:40	33.5378	-50.944	29.056	11.116	-14.648	14.648
10/25/04	10:39:39	35.5225	-50.756	29.244	11.304	-14.626	14.626
10/25/04	10:41:39	37.5225	-50.915	29.085	11.145	-14.612	14.612
10/25/04	10:43:39	39.5225	-51.045	28.955	11.015	-14.590	14.59
10/25/04	10:45:39	41.5225	-50.367	29.633	11.693	-14.576	14.576
10/25/04	10:47:39	43.5225	-50.454	29.546	11.606	-14.547	14.547
10/25/04	10:49:39	45.5225	-51.030	28.970	11.030	-14.540	14.54
10/25/04	10:51:39	47.5225	-50.281	29.719	11.779	-14.519	14.519

10/25/04	10:53:39	49.5225	-50.857	29.143	11.203	-14.511	14.511
10/25/04	10:55:39	51.5225	-50.612	29.388	11.448	-14.490	14.49
10/25/04	10:57:39	53.5225	-50.468	29.532	11.592	-14.476	14.476
10/25/04	10:59:39	55.5225	-50.612	29.388	11.448	-14.468	14.468
10/25/04	11:01:39	57.5225	-50.656	29.344	11.404	-14.454	14.454
10/25/04	11:03:39	59.5225	-50.295	29.705	11.765	-14.440	14.44
10/25/04	11:05:39	61.5225	-48.191	31.809	13.869	-13.952	13.952
10/25/04	11:07:39	63.5225	-47.514	32.486	14.546	-13.830	13.83
10/25/04	11:09:39	65.5225	-47.211	32.789	14.849	-13.780	13.78
10/25/04	11:11:39	67.5225	-47.485	32.515	14.575	-13.751	13.751
10/25/04	11:13:39	69.5225	-47.874	32.126	14.186	-13.723	13.723
10/25/04	11:15:39	71.5225	-48.032	31.968	14.028	-13.701	13.701
10/25/04	11:17:39	73.5225	-47.874	32.126	14.186	-13.679	13.679
10/25/04	11:19:39	75.5225	-47.715	32.285	14.345	-13.658	13.658
10/25/04	11:21:39	77.5225	-48.076	31.924	13.984	-13.651	13.651
10/25/04	11:23:39	79.5225	-47.730	32.270	14.330	-13.622	13.622
10/25/04	11:25:39	81.5225	-48.133	31.867	13.927	-13.608	13.608
10/25/04	11:27:39	83.5225	-47.427	32.573	14.633	-13.601	13.601
10/25/04	11:29:39	85.5225	-47.773	32.227	14.287	-13.586	13.586
10/25/04	11:31:39	87.5225	-46.807	33.193	15.253	-13.558	13.558
10/25/04	11:33:39	89.5225	-47.153	32.847	14.907	-13.558	13.558
10/25/04	11:35:39	91.5225	-47.211	32.789	14.849	-13.536	13.536
10/25/04	11:37:39	93.5225	-47.759	32.241	14.301	-13.536	13.536
10/25/04	11:39:39	95.5225	-47.182	32.818	14.878	-13.522	13.522
10/25/04	11:41:39	97.5225	-47.110	32.890	14.950	-13.507	13.507
10/25/04	11:43:39	99.5225	-47.586	32.414	14.474	-13.500	13.5
10/25/04	11:45:39	101.5225	-47.110	32.890	14.950	-13.472	13.472
10/25/04	11:47:39	103.5225	-47.485	32.515	14.575	-13.464	13.464
10/25/04	11:49:39	105.5225	-47.355	32.645	14.705	-13.457	13.457
10/25/04	11:51:39	107.5225	-47.225	32.775	14.835	-13.450	13.45
10/25/04	11:53:39	109.5225	-47.874	32.126	14.186	-13.436	13.436
10/25/04	11:55:39	111.5225	-47.341	32.659	14.719	-13.421	13.421
10/25/04	11:57:39	113.5225	-47.009	32.991	15.051	-13.414	13.414
10/25/04	11:59:39	115.5225	-47.182	32.818	14.878	-13.400	13.4
10/25/04	12:01:39	117.5225	-47.932	32.068	14.128	-13.393	13.393
10/25/04	12:03:39	119.5225	-46.634	33.366	15.426	-13.385	13.385
10/25/04	12:05:39	121.5225	-43.435	36.565	18.625	-12.812	12.812
10/25/04	12:07:39	123.5225	-43.291	36.709	18.769	-12.683	12.683
10/25/04	12:09:39	125.5225	-43.579	36.421	18.481	-12.640	12.64
10/25/04	12:11:39	127.5225	-43.925	36.075	18.135	-12.604	12.604
10/25/04	12:13:39	129.5225	-43.363	36.637	18.697	-12.582	12.582
10/25/04	12:15:39	131.5225	-43.550	36.450	18.510	-12.568	12.568
10/25/04	12:17:39	133.5225	-43.493	36.507	18.567	-12.546	12.546
10/25/04	12:19:39	135.5225	-43.219	36.781	18.841	-12.532	12.532
10/25/04	12:21:39	137.5225	-43.695	36.305	18.365	-12.503	12.503
10/25/04	12:23:39	139.5225	-43.680	36.320	18.380	-12.503	12.503
10/25/04	12:25:39	141.5225	-43.176	36.824	18.884	-12.489	12.489
10/25/04	12:27:39	143.5225	-43.248	36.752	18.812	-12.475	12.475
10/25/04	12:29:39	145.5225	-43.435	36.565	18.625	-12.460	12.46
10/25/04	12:31:39	147.5225	-43.003	36.997	19.057	-12.453	12.453
10/25/04	12:33:39	149.5225	-43.421	36.579	18.639	-12.453	12.453
10/25/04	12:35:39	151.5225	-43.046	36.954	19.014	-12.439	12.439
10/25/04	12:37:39	153.5225	-43.507	36.493	18.553	-12.424	12.424
10/25/04	12:39:39	155.5225	-43.320	36.680	18.740	-12.424	12.424
10/25/04	12:41:39	157.5225	-43.723	36.277	18.337	-12.417	12.417
10/25/04	12:43:39	159.5225	-43.637	36.363	18.423	-12.410	12.41

10/25/04	12:45:39	161.5225	-42.859	37.141	19.201	-12.403	12.403
10/25/04	12:47:39	163.5225	-43.147	36.853	18.913	-12.389	12.389
10/25/04	12:49:39	165.5225	-43.161	36.839	18.899	-12.374	12.374
10/25/04	12:51:39	167.5225	-43.104	36.896	18.956	-12.367	12.367
10/25/04	12:53:39	169.5225	-43.478	36.522	18.582	-12.374	12.374
10/25/04	12:55:39	171.5225	-42.686	37.314	19.374	-12.360	12.36
10/25/04	12:57:39	173.5225	-43.464	36.536	18.596	-12.353	12.353
10/25/04	12:59:39	175.5225	-43.637	36.363	18.423	-12.346	12.346
10/25/04	13:01:39	177.5225	-43.406	36.594	18.654	-12.338	12.338
10/25/04	13:03:39	179.5225	-43.622	36.378	18.438	-12.331	12.331
10/25/04	13:05:39	181.5225	-36.446	43.554	25.614	-11.334	11.334
10/25/04	13:07:39	183.5225	-36.057	43.943	26.003	-11.062	11.062
10/25/04	13:09:39	185.5225	-35.712	44.288	26.348	-10.990	10.99
10/25/04	13:11:39	187.5225	-36.029	43.971	26.031	-10.933	10.933
10/25/04	13:13:39	189.5225	-35.841	44.159	26.219	-10.890	10.89
10/25/04	13:15:39	191.5225	-36.144	43.856	25.916	-10.854	10.854
10/25/04	13:17:39	193.5225	-35.957	44.043	26.103	-10.832	10.832
10/25/04	13:19:39	195.5225	-35.467	44.533	26.593	-10.818	10.818
10/25/04	13:21:39	197.5225	-36.288	43.712	25.772	-10.796	10.796
10/25/04	13:23:39	199.5225	-35.481	44.519	26.579	-10.775	10.775
10/25/04	13:25:39	201.5225	-35.640	44.360	26.420	-10.761	10.761
10/25/04	13:27:39	203.5225	-36.144	43.856	25.916	-10.739	10.739
10/25/04	13:29:39	205.5225	-35.769	44.231	26.291	-10.725	10.725
10/25/04	13:31:39	207.5225	-35.625	44.375	26.435	-10.718	10.718
10/25/04	13:33:39	209.5225	-35.841	44.159	26.219	-10.696	10.696
10/25/04	13:35:39	211.5225	-35.798	44.202	26.262	-10.689	10.689
10/25/04	13:37:39	213.5225	-35.971	44.029	26.089	-10.675	10.675
10/25/04	13:39:39	215.5225	-35.812	44.188	26.248	-10.667	10.667
10/25/04	13:41:39	217.5225	-36.158	43.842	25.902	-10.653	10.653
10/25/04	13:43:39	219.5225	-36.259	43.741	25.801	-10.646	10.646
10/25/04	13:45:39	221.5225	-36.216	43.784	25.844	-10.646	10.646
10/25/04	13:47:39	223.5225	-35.899	44.101	26.161	-10.631	10.631
10/25/04	13:49:39	225.5225	-36.000	44.000	26.060	-10.610	10.61
10/25/04	13:51:39	227.5225	-35.798	44.202	26.262	-10.617	10.617
10/25/04	13:53:39	229.5225	-35.827	44.173	26.233	-10.610	10.61
10/25/04	13:55:39	231.5225	-35.870	44.130	26.190	-10.610	10.61
10/25/04	13:57:39	233.5225	-35.683	44.317	26.377	-10.603	10.603
10/25/04	13:59:39	235.5225	-35.870	44.130	26.190	-10.596	10.596
10/25/04	14:01:39	237.5225	-35.812	44.188	26.248	-10.588	10.588
10/25/04	14:03:39	239.5225	-36.216	43.784	25.844	-10.581	10.581
10/25/04	14:05:39	241.5225	-28.393	51.607	33.667	-9.498	9.498
10/25/04	14:07:39	243.5225	-27.860	52.140	34.200	-9.255	9.255
10/25/04	14:09:39	245.5225	-27.283	52.717	34.777	-9.176	9.176
10/25/04	14:11:39	247.5225	-27.471	52.529	34.589	-9.118	9.118
10/25/04	14:13:39	249.5225	-27.427	52.573	34.633	-9.082	9.082
10/25/04	14:15:39	251.5225	-28.018	51.982	34.042	-9.047	9.047
10/25/04	14:17:39	253.5225	-27.687	52.313	34.373	-9.025	9.025
10/25/04	14:19:39	255.5225	-27.644	52.356	34.416	-9.004	9.004
10/25/04	14:21:39	257.5225	-27.672	52.328	34.388	-8.982	8.982
10/25/04	14:23:39	259.5225	-27.355	52.645	34.705	-8.968	8.968
10/25/04	14:25:39	261.5225	-27.629	52.371	34.431	-8.960	8.96
10/25/04	14:27:39	263.5225	-27.471	52.529	34.589	-8.932	8.932
10/25/04	14:29:39	265.5225	-27.572	52.428	34.488	-8.925	8.925
10/25/04	14:31:39	267.5225	-27.269	52.731	34.791	-8.903	8.903
10/25/04	14:33:39	269.5225	-27.644	52.356	34.416	-8.882	8.882
10/25/04	14:35:39	271.5225	-27.644	52.356	34.416	-8.874	8.874

10/25/04	14:37:39	273.5225	-27.370	52.630	34.690	-8.853	8.853
10/25/04	14:39:39	275.5225	-27.672	52.328	34.388	-8.846	8.846
10/25/04	14:41:39	277.5225	-27.471	52.529	34.589	-8.839	8.839
10/25/04	14:43:39	279.5225	-27.456	52.544	34.604	-8.831	8.831
10/25/04	14:45:39	281.5225	-27.341	52.659	34.719	-8.824	8.824
10/25/04	14:47:39	283.5225	-27.111	52.889	34.949	-8.810	8.81
10/25/04	14:49:39	285.5225	-27.168	52.832	34.892	-8.810	8.81
10/25/04	14:51:39	287.5225	-27.586	52.414	34.474	-8.810	8.81
10/25/04	14:53:39	289.5225	-27.399	52.601	34.661	-8.810	8.81
10/25/04	14:55:39	291.5225	-27.744	52.256	34.316	-8.810	8.81
10/25/04	14:57:39	293.5225	-27.139	52.861	34.921	-8.810	8.81
10/25/04	14:59:39	295.5225	-27.384	52.616	34.676	-8.803	8.803
10/25/04	15:01:39	297.5225	-27.413	52.587	34.647	-8.796	8.796
10/25/04	15:03:39	299.5225	-27.759	52.241	34.301	-8.796	8.796
10/25/04	15:05:39	301.5225	-27.860	52.140	34.200	-8.788	8.788

Minutes.

<u>TW Orville</u> <u>Drawdown (ft)</u>	<u>Chan[0]</u> <u>Inches Hg</u>
0.012	30.131
0.012	30.131
0.012	30.131
0.012	30.131
0.005	30.131
0.012	30.131
0.012	30.131
0.005	30.131
0.012	30.131
0.012	30.133
0.012	30.133
0.012	30.133
0.012	30.133
0.019	30.137
0.034	30.137
0.048	30.139
0.070	30.141
0.106	30.137
0.156	30.139
0.213	30.137
0.285	30.139
0.364	30.139
0.450	30.137
0.557	30.135
0.672	30.137
0.794	30.137
0.916	30.137
1.045	30.137
1.167	30.137
1.282	30.137
1.382	30.139
1.454	30.135
1.583	30.139
1.662	30.137
1.719	30.139
1.777	30.141
1.827	30.139
1.855	30.139
1.870	30.139
1.884	30.139
1.898	30.137
1.906	30.137
1.927	30.137
1.949	30.137
1.963	30.137
1.985	30.137
2.013	30.137
2.035	30.137
2.071	30.137
2.092	30.139
2.114	30.137
2.142	30.135
2.157	30.139

2.185	30.139
2.207	30.135
2.236	30.135
2.250	30.135
2.286	30.135
2.307	30.135
2.322	30.131
2.336	30.133
2.350	30.133
2.372	30.133
2.393	30.133
2.408	30.135
2.422	30.133
2.436	30.135
2.458	30.135
2.472	30.133
2.501	30.135
2.515	30.133
2.522	30.092
2.537	30.092
2.551	30.090
2.573	30.092
2.587	30.090
2.601	30.092
2.616	30.092
2.630	30.094
2.644	30.092
2.666	30.092
2.680	30.092
2.702	30.092
2.716	30.090
2.730	30.094
2.745	30.094
2.759	30.092
2.773	30.092
2.788	30.092
2.816	30.092
2.831	30.090
2.845	30.090
2.860	30.090
2.874	30.088
2.895	30.088
2.903	30.084
2.931	30.096
2.946	30.129
2.953	30.088
2.981	30.088
3.003	30.088
3.017	30.088
3.039	30.086
3.053	30.084
3.075	30.084
3.089	30.084
3.118	30.119
3.125	30.125
3.146	30.125

3.154	30.123
3.175	30.076
3.189	30.076
3.197	30.078
3.211	30.078
3.225	30.080
3.713	30.074
3.835	30.076
3.885	30.078
3.914	30.123
3.942	30.123
3.964	30.123
3.986	30.123
4.007	30.125
4.014	30.127
4.043	30.125
4.057	30.127
4.064	30.092
4.079	30.080
4.107	30.084
4.107	30.086
4.129	30.086
4.129	30.084
4.143	30.082
4.158	30.084
4.165	30.084
4.193	30.082
4.201	30.082
4.208	30.082
4.215	30.078
4.229	30.127
4.244	30.125
4.251	30.078
4.265	30.121
4.272	30.080
4.280	30.080
4.853	30.080
4.982	30.082
5.025	30.082
5.061	30.084
5.083	30.082
5.097	30.080
5.119	30.078
5.133	30.076
5.162	30.078
5.162	30.078
5.176	30.074
5.190	30.070
5.205	30.070
5.212	30.070
5.212	30.072
5.226	30.066
5.241	30.064
5.241	30.057
5.248	30.055
5.255	30.057

5.262	30.053
5.276	30.053
5.291	30.051
5.298	30.051
5.291	30.049
5.305	30.049
5.312	30.049
5.319	30.049
5.327	30.047
5.334	30.049
6.331	30.098
6.603	30.094
6.675	30.060
6.732	30.057
6.775	30.053
6.811	30.047
6.833	30.045
6.847	30.039
6.869	30.041
6.890	30.043
6.904	30.043
6.926	30.039
6.940	30.037
6.947	30.039
6.969	30.039
6.976	30.041
6.990	30.039
6.998	30.039
7.012	30.039
7.019	30.035
7.019	30.035
7.034	30.088
7.055	30.082
7.048	30.045
7.055	30.037
7.055	30.033
7.062	30.033
7.069	30.031
7.077	30.029
7.084	30.029
8.167	30.031
8.410	30.082
8.489	30.062
8.547	30.039
8.583	30.029
8.618	30.029
8.640	30.031
8.661	30.029
8.683	30.031
8.697	30.029
8.705	30.031
8.733	30.029
8.740	30.029
8.762	30.029
8.783	30.029
8.791	30.029

8.812	30.078
8.819	30.080
8.826	30.039
8.834	30.033
8.841	30.025
8.855	30.025
8.855	30.025
8.855	30.023
8.855	30.025
8.855	30.027
8.855	30.025
8.862	30.021
8.869	30.025
8.869	30.023
8.877	30.074

In-Situ Inc.

Hermit 3000

600 GPM

Report generated:

11/1/04

7:34:48

Report from file:

C:\Win-Situ\Data\SN45674 2004-10-25 162645 DARECO BACKGRD .bin

Mgr Version

3.68

Serial number:

45674

Firmware Version

7.10

Unit name:

HERMIT 3000

Test name:

DARE ORVILLE PUMPTEST

Test defined on:

10/26/04

8:19:13

Test started on:

10/26/04

11:59:34

Test stopped on:

10/28/04

12:04:41

Test extracted on:

11/1/04

8:30:44

Data gathered using Logarithmic testing

Maximum time between data points:

Number of data samples:

1529

TOTAL DATA SAMPLES

1529

Channel number [1]

Measurement type:

Pressure

Channel name:

Probe #1

Linearity:

0.2503

Scale:

Offset:

Warmup:

Specific gravity:

1

Mode:

TOC

User-defined reference:

18.9

Referenced on:

channel definition.

Pressure head at reference:

72.602

Channel number [3]

Measurement type:

Pressure

Channel name:

Probe #3

Linearity:

0.0175000

Scale:

49.7382000

Offset:

-0.2552000

Warmup:

50

Specific gravity:

1.000

Mode:

TOC

User-defined reference:

18.25

Referenced on:

channel definition.

Pressure head at reference:

31.748

Channel number [0]

Measurement type:

Barometric Pressure

Channel name:

Barometric

Linearity:

0.0000000

Scale:

0.0000000

Offset:

0.0000000

Warmup:

50

<u>Date</u>	<u>Time</u>	<u>ET (min)</u>	<u>Chan[1] Feet H2O</u>	<u>Chan[1] Feet H2O</u>	<u>PW Orville Drawdown (ft)</u>	<u>Chan[3] Feet H2O</u>
10/26/04	11:59:34	0.0000	-61.784	18.216	0.001	-17.294
10/26/04	11:59:34	0.0163	-61.669	18.331	0.116	-17.294
10/26/04	11:59:35	0.0327	-61.683	18.317	0.102	-17.294
10/26/04	11:59:36	0.0490	-61.669	18.331	0.116	-17.294
10/26/04	11:59:37	0.0653	-61.669	18.331	0.116	-17.294
10/26/04	11:59:38	0.0817	-61.669	18.331	0.116	-17.294
10/26/04	11:59:39	0.0980	-61.669	18.331	0.116	-17.294
10/26/04	11:59:40	0.1143	-61.669	18.331	0.116	-17.294
10/26/04	11:59:41	0.1307	-61.669	18.331	0.116	-17.294
10/26/04	11:59:42	0.1470	-61.669	18.331	0.116	-17.294
10/26/04	11:59:43	0.1633	-61.669	18.331	0.116	-17.287
10/26/04	11:59:44	0.1797	-61.669	18.331	0.116	-17.294
10/26/04	11:59:45	0.1960	-61.669	18.331	0.116	-17.287
10/26/04	11:59:46	0.2123	-61.669	18.331	0.116	-17.294
10/26/04	11:59:47	0.2287	-61.669	18.331	0.116	-17.294
10/26/04	11:59:48	0.2450	-61.669	18.331	0.116	-17.294
10/26/04	11:59:49	0.2613	-61.669	18.331	0.116	-17.294
10/26/04	11:59:50	0.2777	-61.669	18.331	0.116	-17.287
10/26/04	11:59:51	0.2940	-61.669	18.331	0.116	-17.294
10/26/04	11:59:52	0.3103	-61.669	18.331	0.116	-17.294
10/26/04	11:59:53	0.3267	-61.669	18.331	0.116	-17.294
10/26/04	11:59:54	0.3433	-61.669	18.331	0.116	-17.294
10/26/04	11:59:55	0.3610	-61.669	18.331	0.116	-17.294
10/26/04	11:59:56	0.3797	-57.430	22.570	4.355	-17.294
10/26/04	11:59:57	0.3995	-57.257	22.743	4.528	-17.287
10/26/04	11:59:59	0.4205	-55.182	24.818	6.603	-17.273
10/26/04	12:00:00	0.4427	-53.264	26.736	8.521	-17.237
10/26/04	12:00:01	0.4662	-52.068	27.932	9.717	-17.201
10/26/04	12:00:03	0.4910	-50.641	29.359	11.144	-17.129
10/26/04	12:00:05	0.5173	-49.661	30.339	12.124	-17.029
10/26/04	12:00:06	0.5453	-48.998	31.002	12.787	-16.900
10/26/04	12:00:08	0.5750	-48.436	31.564	13.349	-16.742
10/26/04	12:00:10	0.6063	-47.989	32.011	13.796	-16.641
10/26/04	12:00:12	0.6395	-47.845	32.155	13.940	-16.347
10/26/04	12:00:14	0.6747	-47.845	32.155	13.940	-16.154
10/26/04	12:00:16	0.7120	-47.124	32.876	14.661	-15.960
10/26/04	12:00:19	0.7515	-47.009	32.991	14.776	-15.781
10/26/04	12:00:21	0.7933	-46.663	33.337	15.122	-15.630
10/26/04	12:00:24	0.8377	-46.851	33.149	14.934	-15.480
10/26/04	12:00:27	0.8847	-46.822	33.178	14.963	-15.358
10/26/04	12:00:30	0.9345	-46.764	33.236	15.021	-15.236
10/26/04	12:00:33	0.9872	-46.173	33.827	15.612	-15.121
10/26/04	12:00:36	1.0430	-46.678	33.322	15.107	-15.013
10/26/04	12:00:40	1.1022	-45.770	34.230	16.015	-14.920
10/26/04	12:00:43	1.1648	-46.562	33.438	15.223	-14.827
10/26/04	12:00:47	1.2312	-46.245	33.755	15.540	-14.741
10/26/04	12:00:52	1.3015	-46.000	34.000	15.785	-14.662
10/26/04	12:00:56	1.3760	-46.058	33.942	15.727	-14.583
10/26/04	12:01:01	1.4550	-45.972	34.028	15.813	-14.519
10/26/04	12:01:06	1.5387	-45.712	34.288	16.073	-14.454
10/26/04	12:01:11	1.6272	-45.799	34.201	15.986	-14.389
10/26/04	12:01:17	1.7210	-45.366	34.634	16.419	-14.318
10/26/04	12:01:23	1.8203	-44.775	35.225	17.010	-14.268

10/26/04	12:01:29	1.9257	-45.669	34.331	16.116	-14.203
10/26/04	12:01:36	2.0372	-45.813	34.187	15.972	-14.153
10/26/04	12:01:43	2.1553	-45.698	34.302	16.087	-14.103
10/26/04	12:01:50	2.2805	-45.755	34.245	16.030	-14.060
10/26/04	12:01:58	2.4130	-45.381	34.619	16.404	-14.024
10/26/04	12:02:07	2.5535	-45.626	34.374	16.159	-13.966
10/26/04	12:02:16	2.7023	-45.366	34.634	16.419	-13.931
10/26/04	12:02:25	2.8598	-45.597	34.403	16.188	-13.895
10/26/04	12:02:35	3.0267	-44.992	35.008	16.793	-13.852
10/26/04	12:02:46	3.2035	-45.395	34.605	16.390	-13.823
10/26/04	12:02:57	3.3908	-45.395	34.605	16.390	-13.787
10/26/04	12:03:09	3.5892	-45.582	34.418	16.203	-13.744
10/26/04	12:03:21	3.7993	-45.438	34.562	16.347	-13.723
10/26/04	12:03:35	4.0220	-45.496	34.504	16.289	-13.694
10/26/04	12:03:49	4.2578	-44.343	35.657	17.442	-13.658
10/26/04	12:04:04	4.5077	-44.761	35.239	17.024	-13.629
10/26/04	12:04:20	4.7723	-44.588	35.412	17.197	-13.608
10/26/04	12:04:37	5.0527	-44.992	35.008	16.793	-13.579
10/26/04	12:04:54	5.3495	-45.064	34.936	16.721	-13.558
10/26/04	12:05:13	5.6640	-44.790	35.210	16.995	-13.529
10/26/04	12:05:33	5.9972	-45.020	34.980	16.765	-13.500
10/26/04	12:05:55	6.3500	-44.530	35.470	17.255	-13.479
10/26/04	12:06:17	6.7238	-44.747	35.253	17.038	-13.443
10/26/04	12:06:41	7.1198	-44.919	35.081	16.866	-13.428
10/26/04	12:07:06	7.5392	-44.804	35.196	16.981	-13.407
10/26/04	12:07:33	7.9835	-44.386	35.614	17.399	-13.378
10/26/04	12:08:01	8.4542	-44.300	35.700	17.485	-13.357
10/26/04	12:08:31	8.9527	-44.847	35.153	16.938	-13.328
10/26/04	12:09:02	9.4807	-44.891	35.109	16.894	-13.307
10/26/04	12:09:36	10.0400	-44.502	35.498	17.283	-13.285
10/26/04	12:10:11	10.6325	-44.819	35.181	16.966	-13.264
10/26/04	12:10:49	11.2600	-44.545	35.455	17.240	-13.249
10/26/04	12:11:29	11.9248	-44.430	35.570	17.355	-13.220
10/26/04	12:12:11	12.6290	-44.790	35.210	16.995	-13.206
10/26/04	12:12:56	13.3748	-44.329	35.671	17.456	-13.170
10/26/04	12:13:43	14.1648	-44.833	35.167	16.952	-13.156
10/26/04	12:14:34	15.0017	-44.329	35.671	17.456	-13.120
10/26/04	12:15:27	15.8882	-44.602	35.398	17.183	-13.099
10/26/04	12:16:23	16.8272	-44.127	35.873	17.658	-13.027
10/26/04	12:17:23	17.8218	-43.810	36.190	17.975	-12.977
10/26/04	12:18:26	18.8755	-43.940	36.060	17.845	-12.955
10/26/04	12:19:33	19.9915	-44.199	35.801	17.586	-12.912
10/26/04	12:20:44	21.1737	-44.098	35.902	17.687	-12.891
10/26/04	12:21:59	22.4258	-44.141	35.859	17.644	-12.869
10/26/04	12:23:19	23.7523	-43.781	36.219	18.004	-12.833
10/26/04	12:24:43	25.1573	-43.882	36.118	17.903	-12.812
10/26/04	12:26:12	26.6457	-43.378	36.622	18.407	-12.783
10/26/04	12:27:47	28.2222	-43.507	36.493	18.278	-12.769
10/26/04	12:29:27	29.8920	-44.026	35.974	17.759	-12.733
10/26/04	12:31:13	31.6608	-43.968	36.032	17.817	-12.704
10/26/04	12:33:06	33.5345	-43.954	36.046	17.831	-12.683
10/26/04	12:35:05	35.5192	-43.911	36.089	17.874	-12.661
10/26/04	12:37:05	37.5192	-43.925	36.075	17.860	-12.632
10/26/04	12:39:05	39.5192	-43.435	36.565	18.350	-12.618
10/26/04	12:41:05	41.5192	-44.055	35.945	17.730	-12.589
10/26/04	12:43:05	43.5192	-43.406	36.594	18.379	-12.575

10/26/04	12:45:05	45.5192	-43.493	36.507	18.292	-12.561
10/26/04	12:47:05	47.5192	-43.089	36.911	18.696	-12.532
10/26/04	12:49:05	49.5192	-43.522	36.478	18.263	-12.510
10/26/04	12:51:05	51.5192	-43.795	36.205	17.990	-12.489
10/26/04	12:53:05	53.5192	-43.032	36.968	18.753	-12.475
10/26/04	12:55:05	55.5192	-43.738	36.262	18.047	-12.446
10/26/04	12:57:05	57.5192	-43.392	36.608	18.393	-12.432
10/26/04	12:59:05	59.5192	-43.378	36.622	18.407	-12.424
10/26/04	13:01:05	61.5192	-43.262	36.738	18.523	-12.403
10/26/04	13:03:05	63.5192	-43.334	36.666	18.451	-12.389
10/26/04	13:05:05	65.5192	-43.046	36.954	18.739	-12.381
10/26/04	13:07:05	67.5192	-43.464	36.536	18.321	-12.374
10/26/04	13:09:05	69.5192	-43.205	36.795	18.580	-12.353
10/26/04	13:11:05	71.5192	-43.291	36.709	18.494	-12.346
10/26/04	13:13:05	73.5192	-42.960	37.040	18.825	-12.331
10/26/04	13:15:05	75.5192	-43.421	36.579	18.364	-12.317
10/26/04	13:17:05	77.5192	-43.248	36.752	18.537	-12.310
10/26/04	13:19:05	79.5192	-43.305	36.695	18.480	-12.302
10/26/04	13:21:05	81.5192	-43.464	36.536	18.321	-12.288
10/26/04	13:23:05	83.5192	-43.363	36.637	18.422	-12.274
10/26/04	13:25:05	85.5192	-43.392	36.608	18.393	-12.274
10/26/04	13:27:05	87.5192	-43.032	36.968	18.753	-12.252
10/26/04	13:29:05	89.5192	-43.089	36.911	18.696	-12.245
10/26/04	13:31:05	91.5192	-43.017	36.983	18.768	-12.238
10/26/04	13:33:05	93.5192	-43.219	36.781	18.566	-12.231
10/26/04	13:35:05	95.5192	-43.003	36.997	18.782	-12.224
10/26/04	13:37:05	97.5192	-43.190	36.810	18.595	-12.209
10/26/04	13:39:05	99.5192	-42.859	37.141	18.926	-12.209
10/26/04	13:41:05	101.5192	-43.334	36.666	18.451	-12.195
10/26/04	13:43:05	103.5192	-43.075	36.925	18.710	-12.188
10/26/04	13:45:05	105.5192	-42.916	37.084	18.869	-12.188
10/26/04	13:47:05	107.5192	-43.133	36.867	18.652	-12.173
10/26/04	13:49:05	109.5192	-43.233	36.767	18.552	-12.159
10/26/04	13:51:05	111.5192	-42.916	37.084	18.869	-12.159
10/26/04	13:53:05	113.5192	-42.945	37.055	18.840	-12.152
10/26/04	13:55:05	115.5192	-43.349	36.651	18.436	-12.145
10/26/04	13:57:05	117.5192	-43.233	36.767	18.552	-12.145
10/26/04	13:59:05	119.5192	-43.017	36.983	18.768	-12.138
10/26/04	14:01:05	121.5192	-43.450	36.550	18.335	-12.130
10/26/04	14:03:05	123.5192	-42.988	37.012	18.797	-12.130
10/26/04	14:05:05	125.5192	-43.075	36.925	18.710	-12.116
10/26/04	14:07:05	127.5192	-43.032	36.968	18.753	-12.116
10/26/04	14:09:05	129.5192	-43.219	36.781	18.566	-12.109
10/26/04	14:11:05	131.5192	-42.988	37.012	18.797	-12.109
10/26/04	14:13:05	133.5192	-43.046	36.954	18.739	-12.102
10/26/04	14:15:05	135.5192	-42.945	37.055	18.840	-12.095
10/26/04	14:17:05	137.5192	-43.205	36.795	18.580	-12.095
10/26/04	14:19:05	139.5192	-43.161	36.839	18.624	-12.095
10/26/04	14:21:05	141.5192	-43.046	36.954	18.739	-12.095
10/26/04	14:23:05	143.5192	-43.219	36.781	18.566	-12.080
10/26/04	14:25:05	145.5192	-42.974	37.026	18.811	-12.066
10/26/04	14:27:05	147.5192	-42.571	37.429	19.214	-12.073
10/26/04	14:29:05	149.5192	-42.643	37.357	19.142	-12.059
10/26/04	14:31:05	151.5192	-43.536	36.464	18.249	-12.073
10/26/04	14:33:05	153.5192	-43.233	36.767	18.552	-12.059
10/26/04	14:35:05	155.5192	-42.859	37.141	18.926	-12.059

10/26/04	14:37:05	157.5192	-42.585	37.415	19.200	-12.059
10/26/04	14:39:05	159.5192	-43.147	36.853	18.638	-12.051
10/26/04	14:41:05	161.5192	-43.262	36.738	18.523	-12.059
10/26/04	14:43:05	163.5192	-43.262	36.738	18.523	-12.051
10/26/04	14:45:05	165.5192	-42.902	37.098	18.883	-12.051
10/26/04	14:47:05	167.5192	-43.003	36.997	18.782	-12.044
10/26/04	14:49:05	169.5192	-42.787	37.213	18.998	-12.044
10/26/04	14:51:05	171.5192	-43.161	36.839	18.624	-12.037
10/26/04	14:53:05	173.5192	-42.916	37.084	18.869	-12.037
10/26/04	14:55:05	175.5192	-42.945	37.055	18.840	-12.030
10/26/04	14:57:05	177.5192	-42.830	37.170	18.955	-12.030
10/26/04	14:59:05	179.5192	-42.902	37.098	18.883	-12.030
10/26/04	15:01:05	181.5192	-43.248	36.752	18.537	-12.030
10/26/04	15:03:05	183.5192	-43.046	36.954	18.739	-12.037
10/26/04	15:05:05	185.5192	-42.888	37.112	18.897	-12.030
10/26/04	15:07:05	187.5192	-42.916	37.084	18.869	-12.030
10/26/04	15:09:05	189.5192	-42.844	37.156	18.941	-12.030
10/26/04	15:11:05	191.5192	-43.334	36.666	18.451	-12.030
10/26/04	15:13:05	193.5192	-42.815	37.185	18.970	-12.037
10/26/04	15:15:05	195.5192	-42.988	37.012	18.797	-12.030
10/26/04	15:17:05	197.5192	-43.089	36.911	18.696	-12.037
10/26/04	15:19:05	199.5192	-42.844	37.156	18.941	-12.037
10/26/04	15:21:05	201.5192	-43.478	36.522	18.307	-12.030
10/26/04	15:23:05	203.5192	-43.017	36.983	18.768	-12.037
10/26/04	15:25:05	205.5192	-43.262	36.738	18.523	-12.030
10/26/04	15:27:05	207.5192	-43.190	36.810	18.595	-12.037
10/26/04	15:29:05	209.5192	-43.896	36.104	17.889	-12.037
10/26/04	15:31:05	211.5192	-43.118	36.882	18.667	-12.030
10/26/04	15:33:05	213.5192	-43.349	36.651	18.436	-12.030
10/26/04	15:35:05	215.5192	-42.931	37.069	18.854	-12.037
10/26/04	15:37:05	217.5192	-42.960	37.040	18.825	-12.037
10/26/04	15:39:05	219.5192	-42.758	37.242	19.027	-12.037
10/26/04	15:41:05	221.5192	-42.931	37.069	18.854	-12.044
10/26/04	15:43:05	223.5192	-43.392	36.608	18.393	-12.037
10/26/04	15:45:05	225.5192	-43.536	36.464	18.249	-12.044
10/26/04	15:47:05	227.5192	-43.248	36.752	18.537	-12.044
10/26/04	15:49:05	229.5192	-43.421	36.579	18.364	-12.051
10/26/04	15:51:05	231.5192	-43.017	36.983	18.768	-12.044
10/26/04	15:53:05	233.5192	-43.277	36.723	18.508	-12.044
10/26/04	15:55:05	235.5192	-42.527	37.473	19.258	-12.051
10/26/04	15:57:05	237.5192	-42.743	37.257	19.042	-12.051
10/26/04	15:59:05	239.5192	-43.334	36.666	18.451	-12.059
10/26/04	16:01:05	241.5192	-42.902	37.098	18.883	-12.059
10/26/04	16:03:05	243.5192	-42.426	37.574	19.359	-12.073
10/26/04	16:05:05	245.5192	-42.571	37.429	19.214	-12.073
10/26/04	16:07:05	247.5192	-43.205	36.795	18.580	-12.059
10/26/04	16:09:05	249.5192	-43.248	36.752	18.537	-12.080
10/26/04	16:11:05	251.5192	-43.003	36.997	18.782	-12.080
10/26/04	16:13:05	253.5192	-42.974	37.026	18.811	-12.080
10/26/04	16:15:05	255.5192	-43.032	36.968	18.753	-12.080
10/26/04	16:17:05	257.5192	-43.205	36.795	18.580	-12.080
10/26/04	16:19:05	259.5192	-42.787	37.213	18.998	-12.087
10/26/04	16:21:05	261.5192	-42.801	37.199	18.984	-12.095
10/26/04	16:23:05	263.5192	-43.118	36.882	18.667	-12.102
10/26/04	16:25:05	265.5192	-42.787	37.213	18.998	-12.109
10/26/04	16:27:05	267.5192	-43.406	36.594	18.379	-12.109

10/26/04	16:29:05	269.5192	-42.743	37.257	19.042	-12.109
10/26/04	16:31:05	271.5192	-42.974	37.026	18.811	-12.116
10/26/04	16:33:05	273.5192	-42.700	37.300	19.085	-12.123
10/26/04	16:35:05	275.5192	-43.248	36.752	18.537	-12.123
10/26/04	16:37:05	277.5192	-43.017	36.983	18.768	-12.123
10/26/04	16:39:05	279.5192	-43.133	36.867	18.652	-12.130
10/26/04	16:41:05	281.5192	-43.421	36.579	18.364	-12.130
10/26/04	16:43:05	283.5192	-43.349	36.651	18.436	-12.138
10/26/04	16:45:05	285.5192	-43.104	36.896	18.681	-12.145
10/26/04	16:47:05	287.5192	-43.075	36.925	18.710	-12.145
10/26/04	16:49:05	289.5192	-42.960	37.040	18.825	-12.145
10/26/04	16:51:05	291.5192	-42.239	37.761	19.546	-12.152
10/26/04	16:53:05	293.5192	-43.046	36.954	18.739	-12.152
10/26/04	16:55:05	295.5192	-43.032	36.968	18.753	-12.152
10/26/04	16:57:05	297.5192	-42.830	37.170	18.955	-12.159
10/26/04	16:59:05	299.5192	-43.305	36.695	18.480	-12.166
10/26/04	17:01:05	301.5192	-43.853	36.147	17.932	-12.173
10/26/04	17:03:05	303.5192	-43.060	36.940	18.725	-12.181
10/26/04	17:05:05	305.5192	-43.205	36.795	18.580	-12.173
10/26/04	17:07:05	307.5192	-43.017	36.983	18.768	-12.181
10/26/04	17:09:05	309.5192	-43.262	36.738	18.523	-12.181
10/26/04	17:11:05	311.5192	-43.233	36.767	18.552	-12.188
10/26/04	17:13:05	313.5192	-43.291	36.709	18.494	-12.195
10/26/04	17:15:05	315.5192	-43.219	36.781	18.566	-12.202
10/26/04	17:17:05	317.5192	-42.988	37.012	18.797	-12.202
10/26/04	17:19:05	319.5192	-43.147	36.853	18.638	-12.202
10/26/04	17:21:05	321.5192	-42.844	37.156	18.941	-12.209
10/26/04	17:23:05	323.5192	-42.671	37.329	19.114	-12.209
10/26/04	17:25:05	325.5192	-43.363	36.637	18.422	-12.216
10/26/04	17:27:05	327.5192	-42.960	37.040	18.825	-12.216
10/26/04	17:29:05	329.5192	-43.089	36.911	18.696	-12.224
10/26/04	17:31:05	331.5192	-43.550	36.450	18.235	-12.224
10/26/04	17:33:05	333.5192	-43.118	36.882	18.667	-12.231
10/26/04	17:35:05	335.5192	-43.493	36.507	18.292	-12.231
10/26/04	17:37:05	337.5192	-43.349	36.651	18.436	-12.231
10/26/04	17:39:05	339.5192	-43.392	36.608	18.393	-12.238
10/26/04	17:41:05	341.5192	-43.392	36.608	18.393	-12.252
10/26/04	17:43:05	343.5192	-42.873	37.127	18.912	-12.252
10/26/04	17:45:05	345.5192	-43.017	36.983	18.768	-12.259
10/26/04	17:47:05	347.5192	-43.176	36.824	18.609	-12.259
10/26/04	17:49:05	349.5192	-42.974	37.026	18.811	-12.259
10/26/04	17:51:05	351.5192	-43.205	36.795	18.580	-12.267
10/26/04	17:53:05	353.5192	-43.161	36.839	18.624	-12.274
10/26/04	17:55:05	355.5192	-43.248	36.752	18.537	-12.274
10/26/04	17:57:05	357.5192	-43.349	36.651	18.436	-12.274
10/26/04	17:59:05	359.5192	-43.435	36.565	18.350	-12.281
10/26/04	18:01:05	361.5192	-43.320	36.680	18.465	-12.281
10/26/04	18:03:05	363.5192	-43.104	36.896	18.681	-12.288
10/26/04	18:05:05	365.5192	-43.882	36.118	17.903	-12.295
10/26/04	18:07:05	367.5192	-43.161	36.839	18.624	-12.295
10/26/04	18:09:05	369.5192	-42.888	37.112	18.897	-12.281
10/26/04	18:11:05	371.5192	-43.493	36.507	18.292	-12.288
10/26/04	18:13:05	373.5192	-43.450	36.550	18.335	-12.288
10/26/04	18:15:05	375.5192	-43.363	36.637	18.422	-12.295
10/26/04	18:17:05	377.5192	-43.190	36.810	18.595	-12.295
10/26/04	18:19:05	379.5192	-43.349	36.651	18.436	-12.302

10/26/04	18:21:05	381.5192	-43.118	36.882	18.667	-12.302
10/26/04	18:23:05	383.5192	-42.743	37.257	19.042	-12.310
10/26/04	18:25:05	385.5192	-42.758	37.242	19.027	-12.310
10/26/04	18:27:05	387.5192	-43.421	36.579	18.364	-12.310
10/26/04	18:29:05	389.5192	-43.378	36.622	18.407	-12.317
10/26/04	18:31:05	391.5192	-43.608	36.392	18.177	-12.324
10/26/04	18:33:05	393.5192	-43.752	36.248	18.033	-12.324
10/26/04	18:35:05	395.5192	-42.628	37.372	19.157	-12.324
10/26/04	18:37:05	397.5192	-43.464	36.536	18.321	-12.324
10/26/04	18:39:05	399.5192	-43.334	36.666	18.451	-12.324
10/26/04	18:41:05	401.5192	-43.205	36.795	18.580	-12.331
10/26/04	18:43:05	403.5192	-43.104	36.896	18.681	-12.338
10/26/04	18:45:05	405.5192	-43.464	36.536	18.321	-12.331
10/26/04	18:47:05	407.5192	-43.176	36.824	18.609	-12.331
10/26/04	18:49:05	409.5192	-43.161	36.839	18.624	-12.338
10/26/04	18:51:05	411.5192	-43.378	36.622	18.407	-12.331
10/26/04	18:53:05	413.5192	-43.637	36.363	18.148	-12.338
10/26/04	18:55:05	415.5192	-43.536	36.464	18.249	-12.338
10/26/04	18:57:05	417.5192	-43.147	36.853	18.638	-12.346
10/26/04	18:59:05	419.5192	-43.406	36.594	18.379	-12.346
10/26/04	19:01:05	421.5192	-42.859	37.141	18.926	-12.346
10/26/04	19:03:05	423.5192	-42.931	37.069	18.854	-12.338
10/26/04	19:05:05	425.5192	-43.248	36.752	18.537	-12.338
10/26/04	19:07:05	427.5192	-43.363	36.637	18.422	-12.338
10/26/04	19:09:05	429.5192	-43.046	36.954	18.739	-12.346
10/26/04	19:11:05	431.5192	-43.089	36.911	18.696	-12.346
10/26/04	19:13:05	433.5192	-42.787	37.213	18.998	-12.346
10/26/04	19:15:05	435.5192	-43.147	36.853	18.638	-12.338
10/26/04	19:17:05	437.5192	-42.945	37.055	18.840	-12.353
10/26/04	19:19:05	439.5192	-42.830	37.170	18.955	-12.346
10/26/04	19:21:05	441.5192	-43.507	36.493	18.278	-12.346
10/26/04	19:23:05	443.5192	-43.017	36.983	18.768	-12.346
10/26/04	19:25:05	445.5192	-42.988	37.012	18.797	-12.346
10/26/04	19:27:05	447.5192	-43.464	36.536	18.321	-12.346
10/26/04	19:29:05	449.5192	-42.729	37.271	19.056	-12.338
10/26/04	19:31:05	451.5192	-43.118	36.882	18.667	-12.338
10/26/04	19:33:05	453.5192	-43.363	36.637	18.422	-12.338
10/26/04	19:35:05	455.5192	-43.363	36.637	18.422	-12.331
10/26/04	19:37:05	457.5192	-43.435	36.565	18.350	-12.338
10/26/04	19:39:05	459.5192	-43.435	36.565	18.350	-12.338
10/26/04	19:41:05	461.5192	-43.392	36.608	18.393	-12.338
10/26/04	19:43:05	463.5192	-43.536	36.464	18.249	-12.331
10/26/04	19:45:05	465.5192	-43.248	36.752	18.537	-12.331
10/26/04	19:47:05	467.5192	-43.089	36.911	18.696	-12.331
10/26/04	19:49:05	469.5192	-43.378	36.622	18.407	-12.331
10/26/04	19:51:05	471.5192	-43.003	36.997	18.782	-12.324
10/26/04	19:53:05	473.5192	-43.349	36.651	18.436	-12.324
10/26/04	19:55:05	475.5192	-43.190	36.810	18.595	-12.324
10/26/04	19:57:05	477.5192	-42.787	37.213	18.998	-12.317
10/26/04	19:59:05	479.5192	-43.305	36.695	18.480	-12.317
10/26/04	20:01:05	481.5192	-42.772	37.228	19.013	-12.310
10/26/04	20:03:05	483.5192	-42.729	37.271	19.056	-12.310
10/26/04	20:05:05	485.5192	-43.594	36.406	18.191	-12.310
10/26/04	20:07:05	487.5192	-43.421	36.579	18.364	-12.310
10/26/04	20:09:05	489.5192	-43.017	36.983	18.768	-12.302
10/26/04	20:11:05	491.5192	-42.916	37.084	18.869	-12.302

10/26/04	20:13:05	493.5192	-43.089	36.911	18.696	-12.302
10/26/04	20:15:05	495.5192	-43.378	36.622	18.407	-12.295
10/26/04	20:17:05	497.5192	-43.392	36.608	18.393	-12.295
10/26/04	20:19:05	499.5192	-43.637	36.363	18.148	-12.288
10/26/04	20:21:05	501.5192	-43.147	36.853	18.638	-12.281
10/26/04	20:23:05	503.5192	-43.291	36.709	18.494	-12.281
10/26/04	20:25:05	505.5192	-43.017	36.983	18.768	-12.281
10/26/04	20:27:05	507.5192	-43.032	36.968	18.753	-12.274
10/26/04	20:29:05	509.5192	-43.161	36.839	18.624	-12.274
10/26/04	20:31:05	511.5192	-43.104	36.896	18.681	-12.274
10/26/04	20:33:05	513.5192	-43.277	36.723	18.508	-12.259
10/26/04	20:35:05	515.5192	-43.075	36.925	18.710	-12.259
10/26/04	20:37:05	517.5192	-43.003	36.997	18.782	-12.259
10/26/04	20:39:05	519.5192	-42.888	37.112	18.897	-12.252
10/26/04	20:41:05	521.5192	-43.392	36.608	18.393	-12.252
10/26/04	20:43:05	523.5192	-43.133	36.867	18.652	-12.245
10/26/04	20:45:05	525.5192	-43.046	36.954	18.739	-12.231
10/26/04	20:47:05	527.5192	-43.176	36.824	18.609	-12.224
10/26/04	20:49:05	529.5192	-42.844	37.156	18.941	-12.216
10/26/04	20:51:05	531.5192	-43.205	36.795	18.580	-12.209
10/26/04	20:53:05	533.5192	-43.161	36.839	18.624	-12.209
10/26/04	20:55:05	535.5192	-42.945	37.055	18.840	-12.202
10/26/04	20:57:05	537.5192	-43.017	36.983	18.768	-12.202
10/26/04	20:59:05	539.5192	-43.205	36.795	18.580	-12.195
10/26/04	21:01:05	541.5192	-43.003	36.997	18.782	-12.188
10/26/04	21:03:05	543.5192	-43.594	36.406	18.191	-12.195
10/26/04	21:05:05	545.5192	-42.988	37.012	18.797	-12.188
10/26/04	21:07:05	547.5192	-43.133	36.867	18.652	-12.181
10/26/04	21:09:05	549.5192	-43.349	36.651	18.436	-12.173
10/26/04	21:11:05	551.5192	-42.815	37.185	18.970	-12.173
10/26/04	21:13:05	553.5192	-43.565	36.435	18.220	-12.166
10/26/04	21:15:05	555.5192	-43.262	36.738	18.523	-12.152
10/26/04	21:17:05	557.5192	-42.743	37.257	19.042	-12.159
10/26/04	21:19:05	559.5192	-43.233	36.767	18.552	-12.145
10/26/04	21:21:05	561.5192	-43.017	36.983	18.768	-12.145
10/26/04	21:23:05	563.5192	-43.378	36.622	18.407	-12.138
10/26/04	21:25:05	565.5192	-43.147	36.853	18.638	-12.130
10/26/04	21:27:05	567.5192	-42.297	37.703	19.488	-12.130
10/26/04	21:29:05	569.5192	-42.960	37.040	18.825	-12.116
10/26/04	21:31:05	571.5192	-42.859	37.141	18.926	-12.109
10/26/04	21:33:05	573.5192	-43.392	36.608	18.393	-12.109
10/26/04	21:35:05	575.5192	-42.960	37.040	18.825	-12.109
10/26/04	21:37:05	577.5192	-42.974	37.026	18.811	-12.095
10/26/04	21:39:05	579.5192	-42.787	37.213	18.998	-12.087
10/26/04	21:41:05	581.5192	-42.614	37.386	19.171	-12.080
10/26/04	21:43:05	583.5192	-43.118	36.882	18.667	-12.080
10/26/04	21:45:05	585.5192	-42.657	37.343	19.128	-12.059
10/26/04	21:47:05	587.5192	-43.493	36.507	18.292	-12.059
10/26/04	21:49:05	589.5192	-43.104	36.896	18.681	-12.051
10/26/04	21:51:05	591.5192	-42.945	37.055	18.840	-12.044
10/26/04	21:53:05	593.5192	-42.671	37.329	19.114	-12.037
10/26/04	21:55:05	595.5192	-42.916	37.084	18.869	-12.030
10/26/04	21:57:05	597.5192	-43.104	36.896	18.681	-12.023
10/26/04	21:59:05	599.5192	-42.282	37.718	19.503	-12.008
10/26/04	22:01:05	601.5192	-42.902	37.098	18.883	-12.008
10/26/04	22:03:05	603.5192	-42.700	37.300	19.085	-12.008

10/26/04	22:05:05	605.5192	-42.960	37.040	18.825	-11.994
10/26/04	22:07:05	607.5192	-43.060	36.940	18.725	-11.980
10/26/04	22:09:05	609.5192	-42.715	37.285	19.070	-11.973
10/26/04	22:11:05	611.5192	-43.032	36.968	18.753	-11.973
10/26/04	22:13:05	613.5192	-42.888	37.112	18.897	-11.965
10/26/04	22:15:05	615.5192	-43.003	36.997	18.782	-11.958
10/26/04	22:17:05	617.5192	-42.859	37.141	18.926	-11.951
10/26/04	22:19:05	619.5192	-42.873	37.127	18.912	-11.944
10/26/04	22:21:05	621.5192	-42.311	37.689	19.474	-11.937
10/26/04	22:23:05	623.5192	-43.118	36.882	18.667	-11.930
10/26/04	22:25:05	625.5192	-43.104	36.896	18.681	-11.922
10/26/04	22:27:05	627.5192	-42.614	37.386	19.171	-11.915
10/26/04	22:29:05	629.5192	-43.089	36.911	18.696	-11.908
10/26/04	22:31:05	631.5192	-42.743	37.257	19.042	-11.901
10/26/04	22:33:05	633.5192	-42.974	37.026	18.811	-11.894
10/26/04	22:35:05	635.5192	-42.902	37.098	18.883	-11.879
10/26/04	22:37:05	637.5192	-42.700	37.300	19.085	-11.865
10/26/04	22:39:05	639.5192	-42.441	37.559	19.344	-11.858
10/26/04	22:41:05	641.5192	-42.801	37.199	18.984	-11.851
10/26/04	22:43:05	643.5192	-42.585	37.415	19.200	-11.844
10/26/04	22:45:05	645.5192	-43.003	36.997	18.782	-11.836
10/26/04	22:47:05	647.5192	-42.830	37.170	18.955	-11.822
10/26/04	22:49:05	649.5192	-42.758	37.242	19.027	-11.815
10/26/04	22:51:05	651.5192	-42.527	37.473	19.258	-11.815
10/26/04	22:53:05	653.5192	-42.974	37.026	18.811	-11.808
10/26/04	22:55:05	655.5192	-42.455	37.545	19.330	-11.800
10/26/04	22:57:05	657.5192	-42.527	37.473	19.258	-11.793
10/26/04	22:59:05	659.5192	-42.340	37.660	19.445	-11.779
10/26/04	23:01:05	661.5192	-42.772	37.228	19.013	-11.772
10/26/04	23:03:05	663.5192	-42.643	37.357	19.142	-11.772
10/26/04	23:05:05	665.5192	-43.118	36.882	18.667	-11.765
10/26/04	23:07:05	667.5192	-42.772	37.228	19.013	-11.750
10/26/04	23:09:05	669.5192	-42.873	37.127	18.912	-11.750
10/26/04	23:11:05	671.5192	-42.153	37.847	19.632	-11.743
10/26/04	23:13:05	673.5192	-42.873	37.127	18.912	-11.736
10/26/04	23:15:05	675.5192	-42.859	37.141	18.926	-11.729
10/26/04	23:17:05	677.5192	-42.599	37.401	19.186	-11.714
10/26/04	23:19:05	679.5192	-42.354	37.646	19.431	-11.714
10/26/04	23:21:05	681.5192	-42.988	37.012	18.797	-11.693
10/26/04	23:23:05	683.5192	-42.686	37.314	19.099	-11.693
10/26/04	23:25:05	685.5192	-42.383	37.617	19.402	-11.679
10/26/04	23:27:05	687.5192	-42.210	37.790	19.575	-11.671
10/26/04	23:29:05	689.5192	-42.470	37.530	19.315	-11.671
10/26/04	23:31:05	691.5192	-42.859	37.141	18.926	-11.664
10/26/04	23:33:05	693.5192	-42.268	37.732	19.517	-11.650
10/26/04	23:35:05	695.5192	-42.326	37.674	19.459	-11.643
10/26/04	23:37:05	697.5192	-42.426	37.574	19.359	-11.636
10/26/04	23:39:05	699.5192	-42.614	37.386	19.171	-11.628
10/26/04	23:41:05	701.5192	-42.282	37.718	19.503	-11.621
10/26/04	23:43:05	703.5192	-42.585	37.415	19.200	-11.621
10/26/04	23:45:05	705.5192	-42.729	37.271	19.056	-11.607
10/26/04	23:47:05	707.5192	-42.801	37.199	18.984	-11.600
10/26/04	23:49:05	709.5192	-42.455	37.545	19.330	-11.592
10/26/04	23:51:05	711.5192	-42.455	37.545	19.330	-11.585
10/26/04	23:53:05	713.5192	-42.311	37.689	19.474	-11.578
10/26/04	23:55:05	715.5192	-42.052	37.948	19.733	-11.571

10/26/04	23:57:05	717.5192	-42.297	37.703	19.488	-11.564
10/26/04	23:59:05	719.5192	-42.253	37.747	19.532	-11.557
10/27/04	0:01:05	721.5192	-42.239	37.761	19.546	-11.549
10/27/04	0:03:05	723.5192	-42.412	37.588	19.373	-11.542
10/27/04	0:05:05	725.5192	-42.138	37.862	19.647	-11.535
10/27/04	0:07:05	727.5192	-42.585	37.415	19.200	-11.521
10/27/04	0:09:05	729.5192	-42.326	37.674	19.459	-11.506
10/27/04	0:11:05	731.5192	-42.268	37.732	19.517	-11.499
10/27/04	0:13:05	733.5192	-42.470	37.530	19.315	-11.499
10/27/04	0:15:05	735.5192	-42.614	37.386	19.171	-11.492
10/27/04	0:17:05	737.5192	-42.787	37.213	18.998	-11.485
10/27/04	0:19:05	739.5192	-42.484	37.516	19.301	-11.478
10/27/04	0:21:05	741.5192	-42.643	37.357	19.142	-11.471
10/27/04	0:23:05	743.5192	-42.715	37.285	19.070	-11.463
10/27/04	0:25:05	745.5192	-42.239	37.761	19.546	-11.456
10/27/04	0:27:05	747.5192	-42.657	37.343	19.128	-11.449
10/27/04	0:29:05	749.5192	-42.599	37.401	19.186	-11.442
10/27/04	0:31:05	751.5192	-42.253	37.747	19.532	-11.435
10/27/04	0:33:05	753.5192	-42.354	37.646	19.431	-11.442
10/27/04	0:35:05	755.5192	-41.965	38.035	19.820	-11.428
10/27/04	0:37:05	757.5192	-42.239	37.761	19.546	-11.428
10/27/04	0:39:05	759.5192	-42.455	37.545	19.330	-11.413
10/27/04	0:41:05	761.5192	-42.743	37.257	19.042	-11.413
10/27/04	0:43:05	763.5192	-42.282	37.718	19.503	-11.406
10/27/04	0:45:05	765.5192	-41.720	38.280	20.065	-11.406
10/27/04	0:47:05	767.5192	-42.743	37.257	19.042	-11.399
10/27/04	0:49:05	769.5192	-42.109	37.891	19.676	-11.392
10/27/04	0:51:05	771.5192	-42.455	37.545	19.330	-11.385
10/27/04	0:53:05	773.5192	-42.181	37.819	19.604	-11.377
10/27/04	0:55:05	775.5192	-42.513	37.487	19.272	-11.377
10/27/04	0:57:05	777.5192	-42.599	37.401	19.186	-11.370
10/27/04	0:59:05	779.5192	-42.398	37.602	19.387	-11.363
10/27/04	1:01:05	781.5192	-42.253	37.747	19.532	-11.363
10/27/04	1:03:05	783.5192	-42.715	37.285	19.070	-11.363
10/27/04	1:05:05	785.5192	-41.980	38.020	19.805	-11.356
10/27/04	1:07:05	787.5192	-42.960	37.040	18.825	-11.349
10/27/04	1:09:05	789.5192	-42.326	37.674	19.459	-11.349
10/27/04	1:11:05	791.5192	-42.253	37.747	19.532	-11.341
10/27/04	1:13:05	793.5192	-41.850	38.150	19.935	-11.341
10/27/04	1:15:05	795.5192	-41.994	38.006	19.791	-11.327
10/27/04	1:17:05	797.5192	-42.498	37.502	19.287	-11.327
10/27/04	1:19:05	799.5192	-41.980	38.020	19.805	-11.327
10/27/04	1:21:05	801.5192	-42.426	37.574	19.359	-11.320
10/27/04	1:23:05	803.5192	-42.167	37.833	19.618	-11.313
10/27/04	1:25:05	805.5192	-41.749	38.251	20.036	-11.313
10/27/04	1:27:05	807.5192	-42.095	37.905	19.690	-11.313
10/27/04	1:29:05	809.5192	-42.153	37.847	19.632	-11.313
10/27/04	1:31:05	811.5192	-41.591	38.409	20.194	-11.306
10/27/04	1:33:05	813.5192	-42.542	37.458	19.243	-11.298
10/27/04	1:35:05	815.5192	-42.268	37.732	19.517	-11.306
10/27/04	1:37:05	817.5192	-42.599	37.401	19.186	-11.298
10/27/04	1:39:05	819.5192	-42.585	37.415	19.200	-11.291
10/27/04	1:41:05	821.5192	-41.591	38.409	20.194	-11.291
10/27/04	1:43:05	823.5192	-42.124	37.876	19.661	-11.291
10/27/04	1:45:05	825.5192	-42.081	37.919	19.704	-11.291
10/27/04	1:47:05	827.5192	-41.807	38.193	19.978	-11.291

10/27/04	1:49:05	829.5192	-41.764	38.236	20.021	-11.284
10/27/04	1:51:05	831.5192	-41.951	38.049	19.834	-11.284
10/27/04	1:53:05	833.5192	-41.634	38.366	20.151	-11.284
10/27/04	1:55:05	835.5192	-41.965	38.035	19.820	-11.291
10/27/04	1:57:05	837.5192	-42.484	37.516	19.301	-11.284
10/27/04	1:59:05	839.5192	-42.542	37.458	19.243	-11.284
10/27/04	2:01:05	841.5192	-41.836	38.164	19.949	-11.277
10/27/04	2:03:05	843.5192	-41.749	38.251	20.036	-11.284
10/27/04	2:05:05	845.5192	-41.836	38.164	19.949	-11.277
10/27/04	2:07:05	847.5192	-41.663	38.337	20.122	-11.277
10/27/04	2:09:05	849.5192	-42.282	37.718	19.503	-11.277
10/27/04	2:11:05	851.5192	-41.879	38.121	19.906	-11.277
10/27/04	2:13:05	853.5192	-42.124	37.876	19.661	-11.277
10/27/04	2:15:05	855.5192	-42.484	37.516	19.301	-11.277
10/27/04	2:17:05	857.5192	-41.980	38.020	19.805	-11.277
10/27/04	2:19:05	859.5192	-42.455	37.545	19.330	-11.277
10/27/04	2:21:05	861.5192	-42.455	37.545	19.330	-11.270
10/27/04	2:23:05	863.5192	-41.893	38.107	19.892	-11.277
10/27/04	2:25:05	865.5192	-41.980	38.020	19.805	-11.277
10/27/04	2:27:05	867.5192	-42.326	37.674	19.459	-11.277
10/27/04	2:29:05	869.5192	-41.951	38.049	19.834	-11.277
10/27/04	2:31:05	871.5192	-42.153	37.847	19.632	-11.284
10/27/04	2:33:05	873.5192	-42.167	37.833	19.618	-11.284
10/27/04	2:35:05	875.5192	-42.398	37.602	19.387	-11.284
10/27/04	2:37:05	877.5192	-41.908	38.092	19.877	-11.284
10/27/04	2:39:05	879.5192	-42.556	37.444	19.229	-11.284
10/27/04	2:41:05	881.5192	-42.715	37.285	19.070	-11.291
10/27/04	2:43:05	883.5192	-42.109	37.891	19.676	-11.291
10/27/04	2:45:05	885.5192	-41.908	38.092	19.877	-11.291
10/27/04	2:47:05	887.5192	-42.210	37.790	19.575	-11.291
10/27/04	2:49:05	889.5192	-42.470	37.530	19.315	-11.291
10/27/04	2:51:05	891.5192	-42.354	37.646	19.431	-11.291
10/27/04	2:53:05	893.5192	-41.432	38.568	20.353	-11.291
10/27/04	2:55:05	895.5192	-42.239	37.761	19.546	-11.291
10/27/04	2:57:05	897.5192	-42.253	37.747	19.532	-11.291
10/27/04	2:59:05	899.5192	-42.340	37.660	19.445	-11.291
10/27/04	3:01:05	901.5192	-41.735	38.265	20.050	-11.298
10/27/04	3:03:05	903.5192	-42.210	37.790	19.575	-11.298
10/27/04	3:05:05	905.5192	-41.994	38.006	19.791	-11.298
10/27/04	3:07:05	907.5192	-42.239	37.761	19.546	-11.298
10/27/04	3:09:05	909.5192	-42.167	37.833	19.618	-11.306
10/27/04	3:11:05	911.5192	-42.153	37.847	19.632	-11.306
10/27/04	3:13:05	913.5192	-42.282	37.718	19.503	-11.306
10/27/04	3:15:05	915.5192	-41.634	38.366	20.151	-11.306
10/27/04	3:17:05	917.5192	-42.340	37.660	19.445	-11.313
10/27/04	3:19:05	919.5192	-42.383	37.617	19.402	-11.313
10/27/04	3:21:05	921.5192	-41.850	38.150	19.935	-11.313
10/27/04	3:23:05	923.5192	-42.916	37.084	18.869	-11.320
10/27/04	3:25:05	925.5192	-41.936	38.064	19.849	-11.320
10/27/04	3:27:05	927.5192	-42.455	37.545	19.330	-11.320
10/27/04	3:29:05	929.5192	-42.297	37.703	19.488	-11.320
10/27/04	3:31:05	931.5192	-42.412	37.588	19.373	-11.327
10/27/04	3:33:05	933.5192	-42.239	37.761	19.546	-11.327
10/27/04	3:35:05	935.5192	-42.138	37.862	19.647	-11.334
10/27/04	3:37:05	937.5192	-42.196	37.804	19.589	-11.334
10/27/04	3:39:05	939.5192	-41.821	38.179	19.964	-11.341

10/27/04	3:41:05	941.5192	-42.181	37.819	19.604	-11.341
10/27/04	3:43:05	943.5192	-41.994	38.006	19.791	-11.349
10/27/04	3:45:05	945.5192	-42.124	37.876	19.661	-11.356
10/27/04	3:47:05	947.5192	-42.282	37.718	19.503	-11.356
10/27/04	3:49:05	949.5192	-42.081	37.919	19.704	-11.356
10/27/04	3:51:05	951.5192	-42.225	37.775	19.560	-11.363
10/27/04	3:53:05	953.5192	-42.181	37.819	19.604	-11.363
10/27/04	3:55:05	955.5192	-42.801	37.199	18.984	-11.377
10/27/04	3:57:05	957.5192	-42.109	37.891	19.676	-11.377
10/27/04	3:59:05	959.5192	-41.677	38.323	20.108	-11.385
10/27/04	4:01:05	961.5192	-41.792	38.208	19.993	-11.385
10/27/04	4:03:05	963.5192	-42.167	37.833	19.618	-11.392
10/27/04	4:05:05	965.5192	-42.527	37.473	19.258	-11.399
10/27/04	4:07:05	967.5192	-42.095	37.905	19.690	-11.399
10/27/04	4:09:05	969.5192	-42.153	37.847	19.632	-11.406
10/27/04	4:11:05	971.5192	-42.513	37.487	19.272	-11.406
10/27/04	4:13:05	973.5192	-41.691	38.309	20.094	-11.413
10/27/04	4:15:05	975.5192	-42.037	37.963	19.748	-11.420
10/27/04	4:17:05	977.5192	-42.081	37.919	19.704	-11.420
10/27/04	4:19:05	979.5192	-42.037	37.963	19.748	-11.428
10/27/04	4:21:05	981.5192	-42.354	37.646	19.431	-11.442
10/27/04	4:23:05	983.5192	-42.008	37.992	19.777	-11.456
10/27/04	4:25:05	985.5192	-42.181	37.819	19.604	-11.456
10/27/04	4:27:05	987.5192	-42.412	37.588	19.373	-11.463
10/27/04	4:29:05	989.5192	-42.239	37.761	19.546	-11.463
10/27/04	4:31:05	991.5192	-41.850	38.150	19.935	-11.471
10/27/04	4:33:05	993.5192	-42.988	37.012	18.797	-11.478
10/27/04	4:35:05	995.5192	-42.225	37.775	19.560	-11.485
10/27/04	4:37:05	997.5192	-42.081	37.919	19.704	-11.492
10/27/04	4:39:05	999.5192	-42.614	37.386	19.171	-11.492
10/27/04	4:41:05	1001.5192	-41.836	38.164	19.949	-11.499
10/27/04	4:43:05	1003.5192	-42.729	37.271	19.056	-11.506
10/27/04	4:45:05	1005.5192	-42.484	37.516	19.301	-11.506
10/27/04	4:47:05	1007.5192	-42.571	37.429	19.214	-11.514
10/27/04	4:49:05	1009.5192	-42.556	37.444	19.229	-11.521
10/27/04	4:51:05	1011.5192	-42.124	37.876	19.661	-11.528
10/27/04	4:53:05	1013.5192	-42.542	37.458	19.243	-11.528
10/27/04	4:55:05	1015.5192	-42.326	37.674	19.459	-11.535
10/27/04	4:57:05	1017.5192	-42.109	37.891	19.676	-11.549
10/27/04	4:59:05	1019.5192	-42.297	37.703	19.488	-11.549
10/27/04	5:01:05	1021.5192	-42.441	37.559	19.344	-11.557
10/27/04	5:03:05	1023.5192	-42.138	37.862	19.647	-11.564
10/27/04	5:05:05	1025.5192	-42.369	37.631	19.416	-11.564
10/27/04	5:07:05	1027.5192	-42.614	37.386	19.171	-11.578
10/27/04	5:09:05	1029.5192	-42.196	37.804	19.589	-11.571
10/27/04	5:11:05	1031.5192	-42.455	37.545	19.330	-11.585
10/27/04	5:13:05	1033.5192	-42.239	37.761	19.546	-11.592
10/27/04	5:15:05	1035.5192	-42.801	37.199	18.984	-11.600
10/27/04	5:17:05	1037.5192	-42.743	37.257	19.042	-11.607
10/27/04	5:19:05	1039.5192	-42.585	37.415	19.200	-11.607
10/27/04	5:21:05	1041.5192	-42.282	37.718	19.503	-11.614
10/27/04	5:23:05	1043.5192	-42.081	37.919	19.704	-11.621
10/27/04	5:25:05	1045.5192	-42.369	37.631	19.416	-11.621
10/27/04	5:27:05	1047.5192	-42.484	37.516	19.301	-11.628
10/27/04	5:29:05	1049.5192	-42.772	37.228	19.013	-11.636
10/27/04	5:31:05	1051.5192	-42.743	37.257	19.042	-11.643

10/27/04	5:33:05	1053.5192	-42.585	37.415	19.200	-11.643
10/27/04	5:35:05	1055.5192	-42.081	37.919	19.704	-11.650
10/27/04	5:37:05	1057.5192	-42.398	37.602	19.387	-11.657
10/27/04	5:39:05	1059.5192	-41.879	38.121	19.906	-11.664
10/27/04	5:41:05	1061.5192	-42.599	37.401	19.186	-11.664
10/27/04	5:43:05	1063.5192	-42.498	37.502	19.287	-11.679
10/27/04	5:45:05	1065.5192	-42.758	37.242	19.027	-11.679
10/27/04	5:47:05	1067.5192	-42.815	37.185	18.970	-11.686
10/27/04	5:49:05	1069.5192	-42.614	37.386	19.171	-11.700
10/27/04	5:51:05	1071.5192	-42.225	37.775	19.560	-11.700
10/27/04	5:53:05	1073.5192	-42.585	37.415	19.200	-11.714
10/27/04	5:55:05	1075.5192	-42.700	37.300	19.085	-11.722
10/27/04	5:57:05	1077.5192	-42.743	37.257	19.042	-11.729
10/27/04	5:59:05	1079.5192	-42.066	37.934	19.719	-11.736
10/27/04	6:01:05	1081.5192	-42.542	37.458	19.243	-11.743
10/27/04	6:03:05	1083.5192	-42.628	37.372	19.157	-11.750
10/27/04	6:05:05	1085.5192	-42.873	37.127	18.912	-11.757
10/27/04	6:07:05	1087.5192	-42.340	37.660	19.445	-11.757
10/27/04	6:09:05	1089.5192	-42.556	37.444	19.229	-11.765
10/27/04	6:11:05	1091.5192	-42.859	37.141	18.926	-11.772
10/27/04	6:13:05	1093.5192	-42.830	37.170	18.955	-11.779
10/27/04	6:15:05	1095.5192	-42.484	37.516	19.301	-11.786
10/27/04	6:17:05	1097.5192	-42.729	37.271	19.056	-11.793
10/27/04	6:19:05	1099.5192	-42.758	37.242	19.027	-11.793
10/27/04	6:21:05	1101.5192	-43.104	36.896	18.681	-11.800
10/27/04	6:23:05	1103.5192	-42.441	37.559	19.344	-11.808
10/27/04	6:25:05	1105.5192	-42.354	37.646	19.431	-11.815
10/27/04	6:27:05	1107.5192	-42.671	37.329	19.114	-11.822
10/27/04	6:29:05	1109.5192	-42.974	37.026	18.811	-11.822
10/27/04	6:31:05	1111.5192	-42.859	37.141	18.926	-11.829
10/27/04	6:33:05	1113.5192	-42.268	37.732	19.517	-11.829
10/27/04	6:35:05	1115.5192	-42.484	37.516	19.301	-11.836
10/27/04	6:37:05	1117.5192	-43.089	36.911	18.696	-11.836
10/27/04	6:39:05	1119.5192	-42.210	37.790	19.575	-11.844
10/27/04	6:41:05	1121.5192	-42.383	37.617	19.402	-11.844
10/27/04	6:43:05	1123.5192	-42.700	37.300	19.085	-11.851
10/27/04	6:45:05	1125.5192	-42.729	37.271	19.056	-11.858
10/27/04	6:47:05	1127.5192	-42.873	37.127	18.912	-11.865
10/27/04	6:49:05	1129.5192	-43.205	36.795	18.580	-11.865
10/27/04	6:51:05	1131.5192	-43.147	36.853	18.638	-11.872
10/27/04	6:53:05	1133.5192	-42.888	37.112	18.897	-11.865
10/27/04	6:55:05	1135.5192	-42.772	37.228	19.013	-11.879
10/27/04	6:57:05	1137.5192	-42.960	37.040	18.825	-11.887
10/27/04	6:59:05	1139.5192	-42.715	37.285	19.070	-11.894
10/27/04	7:01:05	1141.5192	-43.032	36.968	18.753	-11.894
10/27/04	7:03:05	1143.5192	-42.614	37.386	19.171	-11.901
10/27/04	7:05:05	1145.5192	-42.643	37.357	19.142	-11.901
10/27/04	7:07:05	1147.5192	-43.046	36.954	18.739	-11.901
10/27/04	7:09:05	1149.5192	-42.758	37.242	19.027	-11.894
10/27/04	7:11:05	1151.5192	-42.657	37.343	19.128	-11.908
10/27/04	7:13:05	1153.5192	-42.527	37.473	19.258	-11.901
10/27/04	7:15:05	1155.5192	-42.830	37.170	18.955	-11.915
10/27/04	7:17:05	1157.5192	-42.815	37.185	18.970	-11.908
10/27/04	7:19:05	1159.5192	-42.830	37.170	18.955	-11.922
10/27/04	7:21:05	1161.5192	-42.844	37.156	18.941	-11.922
10/27/04	7:23:05	1163.5192	-42.715	37.285	19.070	-11.930

10/27/04	7:25:05	1165.5192	-42.614	37.386	19.171	-11.930
10/27/04	7:27:05	1167.5192	-42.542	37.458	19.243	-11.937
10/27/04	7:29:05	1169.5192	-42.830	37.170	18.955	-11.922
10/27/04	7:31:05	1171.5192	-43.291	36.709	18.494	-11.922
10/27/04	7:33:05	1173.5192	-42.628	37.372	19.157	-11.937
10/27/04	7:35:05	1175.5192	-43.003	36.997	18.782	-11.937
10/27/04	7:37:05	1177.5192	-42.614	37.386	19.171	-11.930
10/27/04	7:39:05	1179.5192	-42.628	37.372	19.157	-11.944
10/27/04	7:41:05	1181.5192	-42.743	37.257	19.042	-11.944
10/27/04	7:43:05	1183.5192	-42.671	37.329	19.114	-11.944
10/27/04	7:45:05	1185.5192	-42.931	37.069	18.854	-11.944
10/27/04	7:47:05	1187.5192	-43.176	36.824	18.609	-11.944
10/27/04	7:49:05	1189.5192	-42.426	37.574	19.359	-11.951
10/27/04	7:51:05	1191.5192	-42.628	37.372	19.157	-11.944
10/27/04	7:53:05	1193.5192	-43.118	36.882	18.667	-11.944
10/27/04	7:55:05	1195.5192	-42.772	37.228	19.013	-11.944
10/27/04	7:57:05	1197.5192	-43.046	36.954	18.739	-11.937
10/27/04	7:59:05	1199.5192	-42.643	37.357	19.142	-11.937
10/27/04	8:01:05	1201.5192	-42.916	37.084	18.869	-11.937
10/27/04	8:03:05	1203.5192	-42.801	37.199	18.984	-11.937
10/27/04	8:05:05	1205.5192	-42.326	37.674	19.459	-11.944
10/27/04	8:07:05	1207.5192	-42.902	37.098	18.883	-11.937
10/27/04	8:09:05	1209.5192	-42.945	37.055	18.840	-11.937
10/27/04	8:11:05	1211.5192	-42.527	37.473	19.258	-11.937
10/27/04	8:13:05	1213.5192	-42.369	37.631	19.416	-11.937
10/27/04	8:15:05	1215.5192	-42.801	37.199	18.984	-11.937
10/27/04	8:17:05	1217.5192	-42.412	37.588	19.373	-11.944
10/27/04	8:19:05	1219.5192	-42.671	37.329	19.114	-11.937
10/27/04	8:21:05	1221.5192	-42.643	37.357	19.142	-11.930
10/27/04	8:23:05	1223.5192	-43.003	36.997	18.782	-11.937
10/27/04	8:25:05	1225.5192	-42.801	37.199	18.984	-11.937
10/27/04	8:27:05	1227.5192	-42.758	37.242	19.027	-11.937
10/27/04	8:29:05	1229.5192	-43.104	36.896	18.681	-11.930
10/27/04	8:31:05	1231.5192	-43.046	36.954	18.739	-11.937
10/27/04	8:33:05	1233.5192	-42.787	37.213	18.998	-11.930
10/27/04	8:35:05	1235.5192	-42.988	37.012	18.797	-11.930
10/27/04	8:37:05	1237.5192	-42.527	37.473	19.258	-11.937
10/27/04	8:39:05	1239.5192	-42.498	37.502	19.287	-11.922
10/27/04	8:41:05	1241.5192	-43.046	36.954	18.739	-11.930
10/27/04	8:43:05	1243.5192	-42.542	37.458	19.243	-11.922
10/27/04	8:45:05	1245.5192	-43.060	36.940	18.725	-11.922
10/27/04	8:47:05	1247.5192	-42.412	37.588	19.373	-11.915
10/27/04	8:49:05	1249.5192	-42.470	37.530	19.315	-11.915
10/27/04	8:51:05	1251.5192	-42.916	37.084	18.869	-11.915
10/27/04	8:53:05	1253.5192	-42.369	37.631	19.416	-11.915
10/27/04	8:55:05	1255.5192	-42.498	37.502	19.287	-11.908
10/27/04	8:57:05	1257.5192	-42.628	37.372	19.157	-11.908
10/27/04	8:59:05	1259.5192	-43.060	36.940	18.725	-11.908
10/27/04	9:01:05	1261.5192	-42.253	37.747	19.532	-11.901
10/27/04	9:03:05	1263.5192	-42.801	37.199	18.984	-11.901
10/27/04	9:05:05	1265.5192	-43.032	36.968	18.753	-11.901
10/27/04	9:07:05	1267.5192	-42.844	37.156	18.941	-11.894
10/27/04	9:09:05	1269.5192	-42.859	37.141	18.926	-11.894
10/27/04	9:11:05	1271.5192	-42.772	37.228	19.013	-11.894
10/27/04	9:13:05	1273.5192	-42.801	37.199	18.984	-11.887
10/27/04	9:15:05	1275.5192	-42.960	37.040	18.825	-11.887

10/27/04	9:17:05	1277.5192	-42.916	37.084	18.869	-11.887
10/27/04	9:19:05	1279.5192	-42.743	37.257	19.042	-11.879
10/27/04	9:21:05	1281.5192	-42.239	37.761	19.546	-11.872
10/27/04	9:23:05	1283.5192	-42.426	37.574	19.359	-11.872
10/27/04	9:25:05	1285.5192	-43.378	36.622	18.407	-11.865
10/27/04	9:27:05	1287.5192	-42.844	37.156	18.941	-11.865
10/27/04	9:29:05	1289.5192	-42.657	37.343	19.128	-11.858
10/27/04	9:31:05	1291.5192	-42.844	37.156	18.941	-11.858
10/27/04	9:33:05	1293.5192	-42.643	37.357	19.142	-11.844
10/27/04	9:35:05	1295.5192	-42.571	37.429	19.214	-11.836
10/27/04	9:37:05	1297.5192	-42.931	37.069	18.854	-11.829
10/27/04	9:39:05	1299.5192	-42.715	37.285	19.070	-11.829
10/27/04	9:41:05	1301.5192	-42.239	37.761	19.546	-11.829
10/27/04	9:43:05	1303.5192	-42.037	37.963	19.748	-11.829
10/27/04	9:45:05	1305.5192	-43.089	36.911	18.696	-11.822
10/27/04	9:47:05	1307.5192	-42.311	37.689	19.474	-11.808
10/27/04	9:49:05	1309.5192	-42.354	37.646	19.431	-11.808
10/27/04	9:51:05	1311.5192	-42.671	37.329	19.114	-11.800
10/27/04	9:53:05	1313.5192	-42.470	37.530	19.315	-11.800
10/27/04	9:55:05	1315.5192	-43.104	36.896	18.681	-11.793
10/27/04	9:57:05	1317.5192	-42.960	37.040	18.825	-11.786
10/27/04	9:59:05	1319.5192	-42.960	37.040	18.825	-11.786
10/27/04	10:01:05	1321.5192	-42.542	37.458	19.243	-11.779
10/27/04	10:03:05	1323.5192	-42.282	37.718	19.503	-11.779
10/27/04	10:05:05	1325.5192	-42.787	37.213	18.998	-11.765
10/27/04	10:07:05	1327.5192	-42.268	37.732	19.517	-11.757
10/27/04	10:09:05	1329.5192	-42.513	37.487	19.272	-11.757
10/27/04	10:11:05	1331.5192	-43.104	36.896	18.681	-11.750
10/27/04	10:13:05	1333.5192	-42.628	37.372	19.157	-11.750
10/27/04	10:15:05	1335.5192	-42.354	37.646	19.431	-11.736
10/27/04	10:17:05	1337.5192	-42.498	37.502	19.287	-11.729
10/27/04	10:19:05	1339.5192	-42.614	37.386	19.171	-11.722
10/27/04	10:21:05	1341.5192	-41.836	38.164	19.949	-11.714
10/27/04	10:23:05	1343.5192	-42.585	37.415	19.200	-11.707
10/27/04	10:25:05	1345.5192	-42.369	37.631	19.416	-11.707
10/27/04	10:27:05	1347.5192	-42.167	37.833	19.618	-11.700
10/27/04	10:29:05	1349.5192	-42.455	37.545	19.330	-11.686
10/27/04	10:31:05	1351.5192	-42.931	37.069	18.854	-11.686
10/27/04	10:33:05	1353.5192	-42.801	37.199	18.984	-11.679
10/27/04	10:35:05	1355.5192	-42.484	37.516	19.301	-11.679
10/27/04	10:37:05	1357.5192	-42.354	37.646	19.431	-11.671
10/27/04	10:39:05	1359.5192	-42.095	37.905	19.690	-11.657
10/27/04	10:41:05	1361.5192	-42.109	37.891	19.676	-11.650
10/27/04	10:43:05	1363.5192	-42.181	37.819	19.604	-11.650
10/27/04	10:45:05	1365.5192	-42.455	37.545	19.330	-11.636
10/27/04	10:47:05	1367.5192	-42.758	37.242	19.027	-11.636
10/27/04	10:49:05	1369.5192	-42.729	37.271	19.056	-11.621
10/27/04	10:51:05	1371.5192	-42.657	37.343	19.128	-11.621
10/27/04	10:53:05	1373.5192	-42.974	37.026	18.811	-11.614
10/27/04	10:55:05	1375.5192	-42.801	37.199	18.984	-11.607
10/27/04	10:57:05	1377.5192	-42.686	37.314	19.099	-11.607
10/27/04	10:59:05	1379.5192	-42.715	37.285	19.070	-11.592
10/27/04	11:01:05	1381.5192	-42.542	37.458	19.243	-11.585
10/27/04	11:03:05	1383.5192	-42.974	37.026	18.811	-11.585
10/27/04	11:05:05	1385.5192	-41.893	38.107	19.892	-11.578
10/27/04	11:07:05	1387.5192	-42.181	37.819	19.604	-11.564

10/27/04	11:09:05	1389.5192	-42.297	37.703	19.488	-11.557
10/27/04	11:11:05	1391.5192	-42.484	37.516	19.301	-11.549
10/27/04	11:13:05	1393.5192	-42.023	37.977	19.762	-11.549
10/27/04	11:15:05	1395.5192	-42.571	37.429	19.214	-11.542
10/27/04	11:17:05	1397.5192	-42.340	37.660	19.445	-11.535
10/27/04	11:19:05	1399.5192	-42.138	37.862	19.647	-11.521
10/27/04	11:21:05	1401.5192	-42.628	37.372	19.157	-11.514
10/27/04	11:23:05	1403.5192	-42.686	37.314	19.099	-11.506
10/27/04	11:25:05	1405.5192	-42.210	37.790	19.575	-11.499
10/27/04	11:27:05	1407.5192	-41.994	38.006	19.791	-11.492
10/27/04	11:29:05	1409.5192	-42.138	37.862	19.647	-11.485
10/27/04	11:31:05	1411.5192	-42.153	37.847	19.632	-11.463
10/27/04	11:33:05	1413.5192	-42.556	37.444	19.229	-11.456
10/27/04	11:35:05	1415.5192	-42.426	37.574	19.359	-11.449
10/27/04	11:37:05	1417.5192	-42.124	37.876	19.661	-11.449
10/27/04	11:39:05	1419.5192	-42.311	37.689	19.474	-11.442
10/27/04	11:41:05	1421.5192	-42.830	37.170	18.955	-11.428
10/27/04	11:43:05	1423.5192	-41.836	38.164	19.949	-11.428
10/27/04	11:45:05	1425.5192	-42.095	37.905	19.690	-11.413
10/27/04	11:47:05	1427.5192	-42.153	37.847	19.632	-11.406
10/27/04	11:49:05	1429.5192	-42.253	37.747	19.532	-11.399
10/27/04	11:51:05	1431.5192	-42.441	37.559	19.344	-11.392
10/27/04	11:53:05	1433.5192	-42.844	37.156	18.941	-11.377
10/27/04	11:55:05	1435.5192	-42.210	37.790	19.575	-11.363
10/27/04	11:57:05	1437.5192	-42.297	37.703	19.488	-11.356
10/27/04	11:59:05	1439.5192	-42.268	37.732	19.517	-11.349
10/27/04	12:01:05	1441.5192	-42.008	37.992	19.777	-11.349
10/27/04	12:03:05	1443.5192	-42.095	37.905	19.690	-11.334
10/27/04	12:05:05	1445.5192	-42.181	37.819	19.604	-11.327
10/27/04	12:07:05	1447.5192	-42.066	37.934	19.719	-11.320
10/27/04	12:09:05	1449.5192	-41.951	38.049	19.834	-11.320
10/27/04	12:11:05	1451.5192	-42.239	37.761	19.546	-11.313
10/27/04	12:13:05	1453.5192	-42.153	37.847	19.632	-11.298
10/27/04	12:15:05	1455.5192	-41.778	38.222	20.007	-11.306
10/27/04	12:17:05	1457.5192	-41.576	38.424	20.209	-11.291
10/27/04	12:19:05	1459.5192	-41.951	38.049	19.834	-11.284
10/27/04	12:21:05	1461.5192	-41.792	38.208	19.993	-11.277
10/27/04	12:23:05	1463.5192	-42.023	37.977	19.762	-11.270
10/27/04	12:25:05	1465.5192	-41.792	38.208	19.993	-11.263
10/27/04	12:27:05	1467.5192	-41.807	38.193	19.978	-11.255
10/27/04	12:29:05	1469.5192	-41.980	38.020	19.805	-11.255
10/27/04	12:31:05	1471.5192	-41.965	38.035	19.820	-11.255
10/27/04	12:33:05	1473.5192	-42.311	37.689	19.474	-11.234
10/27/04	12:35:05	1475.5192	-42.138	37.862	19.647	-11.234
10/27/04	12:37:05	1477.5192	-41.965	38.035	19.820	-11.227
10/27/04	12:39:05	1479.5192	-42.383	37.617	19.402	-11.212
10/27/04	12:41:05	1481.5192	-41.764	38.236	20.021	-11.205
10/27/04	12:43:05	1483.5192	-42.426	37.574	19.359	-11.198
10/27/04	12:45:05	1485.5192	-42.081	37.919	19.704	-11.198
10/27/04	12:47:05	1487.5192	-41.764	38.236	20.021	-11.191
10/27/04	12:49:05	1489.5192	-41.922	38.078	19.863	-11.184
10/27/04	12:51:05	1491.5192	-41.879	38.121	19.906	-11.177
10/27/04	12:53:05	1493.5192	-41.908	38.092	19.877	-11.169
10/27/04	12:55:05	1495.5192	-41.648	38.352	20.137	-11.155
10/27/04	12:57:05	1497.5192	-42.282	37.718	19.503	-11.155
10/27/04	12:59:05	1499.5192	-41.864	38.136	19.921	-11.155

10/27/04	13:01:05	1501.5192	-41.720	38.280	20.065	-11.148
10/27/04	13:03:05	1503.5192	-42.052	37.948	19.733	-11.148
10/27/04	13:05:05	1505.5192	-41.533	38.467	20.252	-11.134
10/27/04	13:07:05	1507.5192	-42.383	37.617	19.402	-11.134
10/27/04	13:09:05	1509.5192	-42.109	37.891	19.676	-11.126
10/27/04	13:11:05	1511.5192	-41.490	38.510	20.295	-11.126
10/27/04	13:13:05	1513.5192	-42.239	37.761	19.546	-11.105
10/27/04	13:15:05	1515.5192	-41.821	38.179	19.964	-11.098
10/27/04	13:17:05	1517.5192	-41.893	38.107	19.892	-11.112
10/27/04	13:19:05	1519.5192	-41.619	38.381	20.166	-11.090
10/27/04	13:21:05	1521.5192	-42.369	37.631	19.416	-11.083
10/27/04	13:23:05	1523.5192	-41.980	38.020	19.805	-11.083
10/27/04	13:25:05	1525.5192	-41.576	38.424	20.209	-11.076
10/27/04	13:27:05	1527.5192	-41.562	38.438	20.223	-11.076
10/27/04	13:29:05	1529.5192	-41.547	38.453	20.238	-11.069
10/27/04	13:31:05	1531.5192	-41.807	38.193	19.978	-11.062
10/27/04	13:33:05	1533.5192	-41.403	38.597	20.382	-11.062
10/27/04	13:35:05	1535.5192	-42.066	37.934	19.719	-11.047
10/27/04	13:37:05	1537.5192	-42.196	37.804	19.589	-11.047
10/27/04	13:39:05	1539.5192	-42.109	37.891	19.676	-11.033
10/27/04	13:41:05	1541.5192	-41.374	38.626	20.411	-11.033
10/27/04	13:43:05	1543.5192	-42.239	37.761	19.546	-11.026
10/27/04	13:45:05	1545.5192	-41.533	38.467	20.252	-11.026
10/27/04	13:47:05	1547.5192	-42.326	37.674	19.459	-11.019
10/27/04	13:49:05	1549.5192	-42.023	37.977	19.762	-11.026
10/27/04	13:51:05	1551.5192	-42.253	37.747	19.532	-11.026
10/27/04	13:53:05	1553.5192	-41.720	38.280	20.065	-11.019
10/27/04	13:55:05	1555.5192	-42.210	37.790	19.575	-11.012
10/27/04	13:57:05	1557.5192	-41.836	38.164	19.949	-11.012
10/27/04	13:59:05	1559.5192	-41.980	38.020	19.805	-11.012
10/27/04	14:01:05	1561.5192	-41.374	38.626	20.411	-11.004
10/27/04	14:03:05	1563.5192	-42.354	37.646	19.431	-11.004
10/27/04	14:05:05	1565.5192	-41.821	38.179	19.964	-10.997
10/27/04	14:07:05	1567.5192	-42.167	37.833	19.618	-10.997
10/27/04	14:09:05	1569.5192	-41.504	38.496	20.281	-10.990
10/27/04	14:11:05	1571.5192	-41.547	38.453	20.238	-10.997
10/27/04	14:13:05	1573.5192	-41.663	38.337	20.122	-10.983
10/27/04	14:15:05	1575.5192	-41.720	38.280	20.065	-10.983
10/27/04	14:17:05	1577.5192	-41.504	38.496	20.281	-10.976
10/27/04	14:19:05	1579.5192	-41.288	38.712	20.497	-10.976
10/27/04	14:21:05	1581.5192	-41.706	38.294	20.079	-10.976
10/27/04	14:23:05	1583.5192	-41.720	38.280	20.065	-10.969
10/27/04	14:25:05	1585.5192	-41.735	38.265	20.050	-10.969
10/27/04	14:27:05	1587.5192	-41.994	38.006	19.791	-10.969
10/27/04	14:29:05	1589.5192	-41.936	38.064	19.849	-10.969
10/27/04	14:31:05	1591.5192	-41.821	38.179	19.964	-10.976
10/27/04	14:33:05	1593.5192	-41.836	38.164	19.949	-10.969
10/27/04	14:35:05	1595.5192	-41.360	38.640	20.425	-10.961
10/27/04	14:37:05	1597.5192	-41.792	38.208	19.993	-10.961
10/27/04	14:39:05	1599.5192	-41.706	38.294	20.079	-10.961
10/27/04	14:41:05	1601.5192	-42.138	37.862	19.647	-10.961
10/27/04	14:43:05	1603.5192	-41.720	38.280	20.065	-10.961
10/27/04	14:45:05	1605.5192	-41.461	38.539	20.324	-10.961
10/27/04	14:47:05	1607.5192	-41.475	38.525	20.310	-10.961
10/27/04	14:49:05	1609.5192	-41.591	38.409	20.194	-10.961
10/27/04	14:51:05	1611.5192	-41.605	38.395	20.180	-10.961

10/27/04	14:53:05	1613.5192	-41.230	38.770	20.555	-10.961
10/27/04	14:55:05	1615.5192	-41.807	38.193	19.978	-10.961
10/27/04	14:57:05	1617.5192	-42.066	37.934	19.719	-10.969
10/27/04	14:59:05	1619.5192	-41.360	38.640	20.425	-10.969
10/27/04	15:01:05	1621.5192	-42.167	37.833	19.618	-10.969
10/27/04	15:03:05	1623.5192	-41.879	38.121	19.906	-10.976
10/27/04	15:05:05	1625.5192	-41.317	38.683	20.468	-10.969
10/27/04	15:07:05	1627.5192	-41.792	38.208	19.993	-10.969
10/27/04	15:09:05	1629.5192	-41.576	38.424	20.209	-10.976
10/27/04	15:11:05	1631.5192	-41.749	38.251	20.036	-10.969
10/27/04	15:13:05	1633.5192	-41.461	38.539	20.324	-10.976
10/27/04	15:15:05	1635.5192	-41.432	38.568	20.353	-10.976
10/27/04	15:17:05	1637.5192	-41.547	38.453	20.238	-10.969
10/27/04	15:19:05	1639.5192	-41.879	38.121	19.906	-10.969
10/27/04	15:21:05	1641.5192	-41.663	38.337	20.122	-10.969
10/27/04	15:23:05	1643.5192	-41.029	38.971	20.756	-10.976
10/27/04	15:25:05	1645.5192	-41.980	38.020	19.805	-10.976
10/27/04	15:27:05	1647.5192	-42.052	37.948	19.733	-10.976
10/27/04	15:29:05	1649.5192	-41.821	38.179	19.964	-10.976
10/27/04	15:31:05	1651.5192	-41.591	38.409	20.194	-10.976
10/27/04	15:33:05	1653.5192	-41.720	38.280	20.065	-10.983
10/27/04	15:35:05	1655.5192	-41.850	38.150	19.935	-10.983
10/27/04	15:37:05	1657.5192	-41.980	38.020	19.805	-10.983
10/27/04	15:39:05	1659.5192	-41.389	38.611	20.396	-10.990
10/27/04	15:41:05	1661.5192	-41.879	38.121	19.906	-10.990
10/27/04	15:43:05	1663.5192	-41.908	38.092	19.877	-10.990
10/27/04	15:45:05	1665.5192	-41.965	38.035	19.820	-10.997
10/27/04	15:47:05	1667.5192	-41.547	38.453	20.238	-10.997
10/27/04	15:49:05	1669.5192	-41.634	38.366	20.151	-10.997
10/27/04	15:51:05	1671.5192	-41.691	38.309	20.094	-10.997
10/27/04	15:53:05	1673.5192	-42.037	37.963	19.748	-10.997
10/27/04	15:55:05	1675.5192	-42.052	37.948	19.733	-11.004
10/27/04	15:57:05	1677.5192	-41.864	38.136	19.921	-11.004
10/27/04	15:59:05	1679.5192	-42.037	37.963	19.748	-11.004
10/27/04	16:01:05	1681.5192	-41.562	38.438	20.223	-11.012
10/27/04	16:03:05	1683.5192	-41.764	38.236	20.021	-11.019
10/27/04	16:05:05	1685.5192	-41.936	38.064	19.849	-11.019
10/27/04	16:07:05	1687.5192	-41.519	38.481	20.266	-11.026
10/27/04	16:09:05	1689.5192	-42.210	37.790	19.575	-11.026
10/27/04	16:11:05	1691.5192	-41.850	38.150	19.935	-11.026
10/27/04	16:13:05	1693.5192	-41.836	38.164	19.949	-11.033
10/27/04	16:15:05	1695.5192	-41.504	38.496	20.281	-11.033
10/27/04	16:17:05	1697.5192	-41.490	38.510	20.295	-11.033
10/27/04	16:19:05	1699.5192	-41.836	38.164	19.949	-11.040
10/27/04	16:21:05	1701.5192	-41.446	38.554	20.339	-11.047
10/27/04	16:23:05	1703.5192	-41.648	38.352	20.137	-11.047
10/27/04	16:25:05	1705.5192	-42.181	37.819	19.604	-11.047
10/27/04	16:27:05	1707.5192	-42.441	37.559	19.344	-11.055
10/27/04	16:29:05	1709.5192	-41.346	38.654	20.439	-11.062
10/27/04	16:31:05	1711.5192	-42.023	37.977	19.762	-11.062
10/27/04	16:33:05	1713.5192	-41.605	38.395	20.180	-11.062
10/27/04	16:35:05	1715.5192	-41.461	38.539	20.324	-11.069
10/27/04	16:37:05	1717.5192	-41.735	38.265	20.050	-11.069
10/27/04	16:39:05	1719.5192	-41.475	38.525	20.310	-11.083
10/27/04	16:41:05	1721.5192	-42.253	37.747	19.532	-11.090
10/27/04	16:43:05	1723.5192	-41.576	38.424	20.209	-11.090

10/27/04	16:45:05	1725.5192	-41.634	38.366	20.151	-11.090
10/27/04	16:47:05	1727.5192	-41.562	38.438	20.223	-11.090
10/27/04	16:49:05	1729.5192	-42.153	37.847	19.632	-11.098
10/27/04	16:51:05	1731.5192	-41.475	38.525	20.310	-11.098
10/27/04	16:53:05	1733.5192	-42.095	37.905	19.690	-11.105
10/27/04	16:55:05	1735.5192	-42.181	37.819	19.604	-11.112
10/27/04	16:57:05	1737.5192	-41.749	38.251	20.036	-11.119
10/27/04	16:59:05	1739.5192	-42.383	37.617	19.402	-11.119
10/27/04	17:01:05	1741.5192	-42.153	37.847	19.632	-11.126
10/27/04	17:03:05	1743.5192	-41.951	38.049	19.834	-11.134
10/27/04	17:05:05	1745.5192	-41.980	38.020	19.805	-11.134
10/27/04	17:07:05	1747.5192	-42.441	37.559	19.344	-11.141
10/27/04	17:09:05	1749.5192	-42.109	37.891	19.676	-11.148
10/27/04	17:11:05	1751.5192	-42.167	37.833	19.618	-11.148
10/27/04	17:13:05	1753.5192	-42.037	37.963	19.748	-11.155
10/27/04	17:15:05	1755.5192	-42.340	37.660	19.445	-11.162
10/27/04	17:17:05	1757.5192	-42.153	37.847	19.632	-11.169
10/27/04	17:19:05	1759.5192	-41.576	38.424	20.209	-11.169
10/27/04	17:21:05	1761.5192	-42.124	37.876	19.661	-11.184
10/27/04	17:23:05	1763.5192	-42.297	37.703	19.488	-11.184
10/27/04	17:25:05	1765.5192	-42.210	37.790	19.575	-11.191
10/27/04	17:27:05	1767.5192	-41.576	38.424	20.209	-11.191
10/27/04	17:29:05	1769.5192	-42.037	37.963	19.748	-11.205
10/27/04	17:31:05	1771.5192	-41.994	38.006	19.791	-11.205
10/27/04	17:33:05	1773.5192	-41.706	38.294	20.079	-11.212
10/27/04	17:35:05	1775.5192	-42.138	37.862	19.647	-11.212
10/27/04	17:37:05	1777.5192	-42.037	37.963	19.748	-11.212
10/27/04	17:39:05	1779.5192	-41.735	38.265	20.050	-11.227
10/27/04	17:41:05	1781.5192	-41.994	38.006	19.791	-11.227
10/27/04	17:43:05	1783.5192	-42.023	37.977	19.762	-11.234
10/27/04	17:45:05	1785.5192	-42.181	37.819	19.604	-11.241
10/27/04	17:47:05	1787.5192	-42.498	37.502	19.287	-11.248
10/27/04	17:49:05	1789.5192	-41.836	38.164	19.949	-11.248
10/27/04	17:51:05	1791.5192	-42.167	37.833	19.618	-11.255
10/27/04	17:53:05	1793.5192	-42.037	37.963	19.748	-11.263
10/27/04	17:55:05	1795.5192	-42.124	37.876	19.661	-11.263
10/27/04	17:57:05	1797.5192	-41.908	38.092	19.877	-11.270
10/27/04	17:59:05	1799.5192	-42.758	37.242	19.027	-11.284
10/27/04	18:01:05	1801.5192	-42.239	37.761	19.546	-11.291
10/27/04	18:03:05	1803.5192	-42.138	37.862	19.647	-11.298
10/27/04	18:05:05	1805.5192	-41.893	38.107	19.892	-11.298
10/27/04	18:07:05	1807.5192	-42.210	37.790	19.575	-11.306
10/27/04	18:09:05	1809.5192	-42.210	37.790	19.575	-11.320
10/27/04	18:11:05	1811.5192	-42.052	37.948	19.733	-11.313
10/27/04	18:13:05	1813.5192	-42.657	37.343	19.128	-11.320
10/27/04	18:15:05	1815.5192	-42.441	37.559	19.344	-11.327
10/27/04	18:17:05	1817.5192	-42.571	37.429	19.214	-11.334
10/27/04	18:19:05	1819.5192	-42.052	37.948	19.733	-11.341
10/27/04	18:21:05	1821.5192	-41.821	38.179	19.964	-11.349
10/27/04	18:23:05	1823.5192	-41.936	38.064	19.849	-11.349
10/27/04	18:25:05	1825.5192	-41.994	38.006	19.791	-11.356
10/27/04	18:27:05	1827.5192	-42.498	37.502	19.287	-11.363
10/27/04	18:29:05	1829.5192	-42.441	37.559	19.344	-11.370
10/27/04	18:31:05	1831.5192	-42.484	37.516	19.301	-11.370
10/27/04	18:33:05	1833.5192	-42.369	37.631	19.416	-11.377
10/27/04	18:35:05	1835.5192	-42.095	37.905	19.690	-11.385

10/27/04	18:37:05	1837.5192	-42.311	37.689	19.474	-11.392
10/27/04	18:39:05	1839.5192	-41.504	38.496	20.281	-11.392
10/27/04	18:41:05	1841.5192	-42.167	37.833	19.618	-11.392
10/27/04	18:43:05	1843.5192	-42.354	37.646	19.431	-11.399
10/27/04	18:45:05	1845.5192	-42.787	37.213	18.998	-11.413
10/27/04	18:47:05	1847.5192	-42.153	37.847	19.632	-11.413
10/27/04	18:49:05	1849.5192	-42.081	37.919	19.704	-11.406
10/27/04	18:51:05	1851.5192	-42.671	37.329	19.114	-11.413
10/27/04	18:53:05	1853.5192	-41.720	38.280	20.065	-11.420
10/27/04	18:55:05	1855.5192	-42.326	37.674	19.459	-11.420
10/27/04	18:57:05	1857.5192	-42.253	37.747	19.532	-11.428
10/27/04	18:59:05	1859.5192	-42.095	37.905	19.690	-11.435
10/27/04	19:01:05	1861.5192	-42.196	37.804	19.589	-11.435
10/27/04	19:03:05	1863.5192	-42.138	37.862	19.647	-11.442
10/27/04	19:05:05	1865.5192	-42.066	37.934	19.719	-11.442
10/27/04	19:07:05	1867.5192	-41.648	38.352	20.137	-11.449
10/27/04	19:09:05	1869.5192	-42.311	37.689	19.474	-11.449
10/27/04	19:11:05	1871.5192	-41.980	38.020	19.805	-11.449
10/27/04	19:13:05	1873.5192	-42.354	37.646	19.431	-11.449
10/27/04	19:15:05	1875.5192	-42.153	37.847	19.632	-11.456
10/27/04	19:17:05	1877.5192	-42.513	37.487	19.272	-11.463
10/27/04	19:19:05	1879.5192	-42.484	37.516	19.301	-11.463
10/27/04	19:21:05	1881.5192	-41.749	38.251	20.036	-11.478
10/27/04	19:23:05	1883.5192	-42.109	37.891	19.676	-11.471
10/27/04	19:25:05	1885.5192	-42.412	37.588	19.373	-11.471
10/27/04	19:27:05	1887.5192	-41.720	38.280	20.065	-11.471
10/27/04	19:29:05	1889.5192	-42.340	37.660	19.445	-11.478
10/27/04	19:31:05	1891.5192	-42.066	37.934	19.719	-11.478
10/27/04	19:33:05	1893.5192	-41.965	38.035	19.820	-11.485
10/27/04	19:35:05	1895.5192	-42.671	37.329	19.114	-11.492
10/27/04	19:37:05	1897.5192	-42.253	37.747	19.532	-11.492
10/27/04	19:39:05	1899.5192	-42.167	37.833	19.618	-11.492
10/27/04	19:41:05	1901.5192	-42.383	37.617	19.402	-11.492
10/27/04	19:43:05	1903.5192	-42.326	37.674	19.459	-11.492
10/27/04	19:45:05	1905.5192	-42.484	37.516	19.301	-11.499
10/27/04	19:47:05	1907.5192	-42.225	37.775	19.560	-11.499
10/27/04	19:49:05	1909.5192	-42.398	37.602	19.387	-11.499
10/27/04	19:51:05	1911.5192	-42.628	37.372	19.157	-11.499
10/27/04	19:53:05	1913.5192	-42.758	37.242	19.027	-11.506
10/27/04	19:55:05	1915.5192	-42.542	37.458	19.243	-11.506
10/27/04	19:57:05	1917.5192	-42.470	37.530	19.315	-11.514
10/27/04	19:59:05	1919.5192	-41.792	38.208	19.993	-11.514
10/27/04	20:01:05	1921.5192	-42.225	37.775	19.560	-11.514
10/27/04	20:03:05	1923.5192	-42.023	37.977	19.762	-11.514
10/27/04	20:05:05	1925.5192	-42.297	37.703	19.488	-11.514
10/27/04	20:07:05	1927.5192	-42.340	37.660	19.445	-11.521
10/27/04	20:09:05	1929.5192	-41.764	38.236	20.021	-11.521
10/27/04	20:11:05	1931.5192	-42.023	37.977	19.762	-11.521
10/27/04	20:13:05	1933.5192	-42.311	37.689	19.474	-11.521
10/27/04	20:15:05	1935.5192	-42.671	37.329	19.114	-11.521
10/27/04	20:17:05	1937.5192	-42.354	37.646	19.431	-11.514
10/27/04	20:19:05	1939.5192	-42.297	37.703	19.488	-11.521
10/27/04	20:21:05	1941.5192	-42.008	37.992	19.777	-11.521
10/27/04	20:23:05	1943.5192	-42.081	37.919	19.704	-11.521
10/27/04	20:25:05	1945.5192	-42.153	37.847	19.632	-11.521
10/27/04	20:27:05	1947.5192	-42.253	37.747	19.532	-11.521

10/27/04	20:29:05	1949.5192	-42.441	37.559	19.344	-11.521
10/27/04	20:31:05	1951.5192	-42.657	37.343	19.128	-11.521
10/27/04	20:33:05	1953.5192	-42.383	37.617	19.402	-11.521
10/27/04	20:35:05	1955.5192	-42.167	37.833	19.618	-11.521
10/27/04	20:37:05	1957.5192	-42.282	37.718	19.503	-11.514
10/27/04	20:39:05	1959.5192	-42.181	37.819	19.604	-11.514
10/27/04	20:41:05	1961.5192	-42.412	37.588	19.373	-11.506
10/27/04	20:43:05	1963.5192	-42.758	37.242	19.027	-11.514
10/27/04	20:45:05	1965.5192	-42.066	37.934	19.719	-11.514
10/27/04	20:47:05	1967.5192	-42.037	37.963	19.748	-11.506
10/27/04	20:49:05	1969.5192	-42.153	37.847	19.632	-11.514
10/27/04	20:51:05	1971.5192	-41.965	38.035	19.820	-11.514
10/27/04	20:53:05	1973.5192	-42.398	37.602	19.387	-11.514
10/27/04	20:55:05	1975.5192	-42.095	37.905	19.690	-11.514
10/27/04	20:57:05	1977.5192	-42.052	37.948	19.733	-11.514
10/27/04	20:59:05	1979.5192	-42.311	37.689	19.474	-11.506
10/27/04	21:01:05	1981.5192	-42.527	37.473	19.258	-11.514
10/27/04	21:03:05	1983.5192	-42.095	37.905	19.690	-11.514
10/27/04	21:05:05	1985.5192	-42.556	37.444	19.229	-11.506
10/27/04	21:07:05	1987.5192	-41.980	38.020	19.805	-11.506
10/27/04	21:09:05	1989.5192	-42.671	37.329	19.114	-11.499
10/27/04	21:11:05	1991.5192	-42.354	37.646	19.431	-11.506
10/27/04	21:13:05	1993.5192	-42.167	37.833	19.618	-11.499
10/27/04	21:15:05	1995.5192	-42.426	37.574	19.359	-11.492
10/27/04	21:17:05	1997.5192	-42.297	37.703	19.488	-11.492
10/27/04	21:19:05	1999.5192	-42.326	37.674	19.459	-11.485
10/27/04	21:21:05	2001.5192	-42.081	37.919	19.704	-11.492
10/27/04	21:23:05	2003.5192	-42.297	37.703	19.488	-11.485
10/27/04	21:25:05	2005.5192	-42.268	37.732	19.517	-11.485
10/27/04	21:27:05	2007.5192	-41.936	38.064	19.849	-11.478
10/27/04	21:29:05	2009.5192	-42.196	37.804	19.589	-11.471
10/27/04	21:31:05	2011.5192	-42.008	37.992	19.777	-11.471
10/27/04	21:33:05	2013.5192	-41.980	38.020	19.805	-11.471
10/27/04	21:35:05	2015.5192	-42.138	37.862	19.647	-11.463
10/27/04	21:37:05	2017.5192	-42.066	37.934	19.719	-11.463
10/27/04	21:39:05	2019.5192	-42.484	37.516	19.301	-11.449
10/27/04	21:41:05	2021.5192	-42.311	37.689	19.474	-11.449
10/27/04	21:43:05	2023.5192	-42.268	37.732	19.517	-11.442
10/27/04	21:45:05	2025.5192	-41.879	38.121	19.906	-11.435
10/27/04	21:47:05	2027.5192	-42.455	37.545	19.330	-11.435
10/27/04	21:49:05	2029.5192	-42.181	37.819	19.604	-11.435
10/27/04	21:51:05	2031.5192	-42.369	37.631	19.416	-11.428
10/27/04	21:53:05	2033.5192	-41.792	38.208	19.993	-11.428
10/27/04	21:55:05	2035.5192	-42.297	37.703	19.488	-11.420
10/27/04	21:57:05	2037.5192	-41.706	38.294	20.079	-11.420
10/27/04	21:59:05	2039.5192	-42.916	37.084	18.869	-11.413
10/27/04	22:01:05	2041.5192	-41.807	38.193	19.978	-11.413
10/27/04	22:03:05	2043.5192	-42.282	37.718	19.503	-11.406
10/27/04	22:05:05	2045.5192	-42.210	37.790	19.575	-11.399
10/27/04	22:07:05	2047.5192	-42.052	37.948	19.733	-11.399
10/27/04	22:09:05	2049.5192	-42.772	37.228	19.013	-11.392
10/27/04	22:11:05	2051.5192	-42.297	37.703	19.488	-11.392
10/27/04	22:13:05	2053.5192	-42.426	37.574	19.359	-11.385
10/27/04	22:15:05	2055.5192	-41.980	38.020	19.805	-11.385
10/27/04	22:17:05	2057.5192	-42.081	37.919	19.704	-11.385
10/27/04	22:19:05	2059.5192	-41.778	38.222	20.007	-11.370

10/27/04	22:21:05	2061.5192	-42.628	37.372	19.157	-11.370
10/27/04	22:23:05	2063.5192	-42.095	37.905	19.690	-11.370
10/27/04	22:25:05	2065.5192	-42.138	37.862	19.647	-11.356
10/27/04	22:27:05	2067.5192	-42.498	37.502	19.287	-11.356
10/27/04	22:29:05	2069.5192	-42.441	37.559	19.344	-11.349
10/27/04	22:31:05	2071.5192	-41.936	38.064	19.849	-11.349
10/27/04	22:33:05	2073.5192	-41.677	38.323	20.108	-11.341
10/27/04	22:35:05	2075.5192	-42.455	37.545	19.330	-11.341
10/27/04	22:37:05	2077.5192	-42.109	37.891	19.676	-11.334
10/27/04	22:39:05	2079.5192	-41.879	38.121	19.906	-11.327
10/27/04	22:41:05	2081.5192	-41.836	38.164	19.949	-11.320
10/27/04	22:43:05	2083.5192	-42.888	37.112	18.897	-11.313
10/27/04	22:45:05	2085.5192	-41.778	38.222	20.007	-11.320
10/27/04	22:47:05	2087.5192	-42.109	37.891	19.676	-11.313
10/27/04	22:49:05	2089.5192	-41.735	38.265	20.050	-11.298
10/27/04	22:51:05	2091.5192	-42.210	37.790	19.575	-11.306
10/27/04	22:53:05	2093.5192	-42.426	37.574	19.359	-11.298
10/27/04	22:55:05	2095.5192	-42.066	37.934	19.719	-11.298
10/27/04	22:57:05	2097.5192	-41.893	38.107	19.892	-11.277
10/27/04	22:59:05	2099.5192	-42.167	37.833	19.618	-11.270
10/27/04	23:01:05	2101.5192	-41.864	38.136	19.921	-11.263
10/27/04	23:03:05	2103.5192	-42.153	37.847	19.632	-11.263
10/27/04	23:05:05	2105.5192	-41.980	38.020	19.805	-11.255
10/27/04	23:07:05	2107.5192	-41.994	38.006	19.791	-11.255
10/27/04	23:09:05	2109.5192	-41.807	38.193	19.978	-11.248
10/27/04	23:11:05	2111.5192	-41.994	38.006	19.791	-11.234
10/27/04	23:13:05	2113.5192	-41.908	38.092	19.877	-11.227
10/27/04	23:15:05	2115.5192	-41.922	38.078	19.863	-11.227
10/27/04	23:17:05	2117.5192	-42.225	37.775	19.560	-11.220
10/27/04	23:19:05	2119.5192	-41.879	38.121	19.906	-11.212
10/27/04	23:21:05	2121.5192	-42.153	37.847	19.632	-11.198
10/27/04	23:23:05	2123.5192	-42.239	37.761	19.546	-11.198
10/27/04	23:25:05	2125.5192	-42.181	37.819	19.604	-11.191
10/27/04	23:27:05	2127.5192	-41.720	38.280	20.065	-11.191
10/27/04	23:29:05	2129.5192	-42.369	37.631	19.416	-11.177
10/27/04	23:31:05	2131.5192	-42.470	37.530	19.315	-11.177
10/27/04	23:33:05	2133.5192	-42.008	37.992	19.777	-11.169
10/27/04	23:35:05	2135.5192	-41.403	38.597	20.382	-11.162
10/27/04	23:37:05	2137.5192	-41.720	38.280	20.065	-11.155
10/27/04	23:39:05	2139.5192	-41.908	38.092	19.877	-11.148
10/27/04	23:41:05	2141.5192	-41.663	38.337	20.122	-11.148
10/27/04	23:43:05	2143.5192	-42.167	37.833	19.618	-11.134
10/27/04	23:45:05	2145.5192	-41.475	38.525	20.310	-11.134
10/27/04	23:47:05	2147.5192	-42.008	37.992	19.777	-11.126
10/27/04	23:49:05	2149.5192	-42.441	37.559	19.344	-11.119
10/27/04	23:51:05	2151.5192	-41.663	38.337	20.122	-11.112
10/27/04	23:53:05	2153.5192	-41.490	38.510	20.295	-11.098
10/27/04	23:55:05	2155.5192	-41.475	38.525	20.310	-11.090
10/27/04	23:57:05	2157.5192	-42.181	37.819	19.604	-11.083
10/27/04	23:59:05	2159.5192	-41.418	38.582	20.367	-11.076
10/28/04	0:01:05	2161.5192	-41.836	38.164	19.949	-11.076
10/28/04	0:03:05	2163.5192	-42.023	37.977	19.762	-11.069
10/28/04	0:05:05	2165.5192	-41.504	38.496	20.281	-11.062
10/28/04	0:07:05	2167.5192	-41.576	38.424	20.209	-11.055
10/28/04	0:09:05	2169.5192	-41.533	38.467	20.252	-11.047
10/28/04	0:11:05	2171.5192	-41.864	38.136	19.921	-11.047

10/28/04	0:13:05	2173.5192	-42.138	37.862	19.647	-11.040
10/28/04	0:15:05	2175.5192	-41.778	38.222	20.007	-11.033
10/28/04	0:17:05	2177.5192	-41.403	38.597	20.382	-11.026
10/28/04	0:19:05	2179.5192	-42.455	37.545	19.330	-11.019
10/28/04	0:21:05	2181.5192	-41.663	38.337	20.122	-11.012
10/28/04	0:23:05	2183.5192	-41.879	38.121	19.906	-11.004
10/28/04	0:25:05	2185.5192	-41.634	38.366	20.151	-11.004
10/28/04	0:27:05	2187.5192	-42.037	37.963	19.748	-10.997
10/28/04	0:29:05	2189.5192	-41.547	38.453	20.238	-10.997
10/28/04	0:31:05	2191.5192	-41.994	38.006	19.791	-10.990
10/28/04	0:33:05	2193.5192	-41.619	38.381	20.166	-10.976
10/28/04	0:35:05	2195.5192	-41.461	38.539	20.324	-10.983
10/28/04	0:37:05	2197.5192	-42.052	37.948	19.733	-10.969
10/28/04	0:39:05	2199.5192	-42.052	37.948	19.733	-10.969
10/28/04	0:41:05	2201.5192	-41.648	38.352	20.137	-10.961
10/28/04	0:43:05	2203.5192	-41.403	38.597	20.382	-10.954
10/28/04	0:45:05	2205.5192	-41.980	38.020	19.805	-10.947
10/28/04	0:47:05	2207.5192	-41.864	38.136	19.921	-10.947
10/28/04	0:49:05	2209.5192	-42.225	37.775	19.560	-10.940
10/28/04	0:51:05	2211.5192	-42.225	37.775	19.560	-10.933
10/28/04	0:53:05	2213.5192	-41.850	38.150	19.935	-10.918
10/28/04	0:55:05	2215.5192	-41.735	38.265	20.050	-10.911
10/28/04	0:57:05	2217.5192	-42.225	37.775	19.560	-10.911
10/28/04	0:59:05	2219.5192	-41.879	38.121	19.906	-10.904
10/28/04	1:01:05	2221.5192	-41.706	38.294	20.079	-10.897
10/28/04	1:03:05	2223.5192	-41.691	38.309	20.094	-10.897
10/28/04	1:05:05	2225.5192	-41.908	38.092	19.877	-10.890
10/28/04	1:07:05	2227.5192	-41.374	38.626	20.411	-10.882
10/28/04	1:09:05	2229.5192	-41.389	38.611	20.396	-10.875
10/28/04	1:11:05	2231.5192	-42.037	37.963	19.748	-10.875
10/28/04	1:13:05	2233.5192	-41.605	38.395	20.180	-10.868
10/28/04	1:15:05	2235.5192	-41.446	38.554	20.339	-10.861
10/28/04	1:17:05	2237.5192	-41.634	38.366	20.151	-10.861
10/28/04	1:19:05	2239.5192	-41.691	38.309	20.094	-10.854
10/28/04	1:21:05	2241.5192	-41.922	38.078	19.863	-10.854
10/28/04	1:23:05	2243.5192	-42.037	37.963	19.748	-10.847
10/28/04	1:25:05	2245.5192	-41.706	38.294	20.079	-10.847
10/28/04	1:27:05	2247.5192	-41.691	38.309	20.094	-10.839
10/28/04	1:29:05	2249.5192	-41.158	38.842	20.627	-10.839
10/28/04	1:31:05	2251.5192	-41.317	38.683	20.468	-10.832
10/28/04	1:33:05	2253.5192	-41.778	38.222	20.007	-10.832
10/28/04	1:35:05	2255.5192	-42.008	37.992	19.777	-10.832
10/28/04	1:37:05	2257.5192	-41.461	38.539	20.324	-10.825
10/28/04	1:39:05	2259.5192	-41.547	38.453	20.238	-10.825
10/28/04	1:41:05	2261.5192	-41.864	38.136	19.921	-10.818
10/28/04	1:43:05	2263.5192	-41.764	38.236	20.021	-10.818
10/28/04	1:45:05	2265.5192	-41.317	38.683	20.468	-10.811
10/28/04	1:47:05	2267.5192	-41.317	38.683	20.468	-10.811
10/28/04	1:49:05	2269.5192	-41.072	38.928	20.713	-10.811
10/28/04	1:51:05	2271.5192	-41.807	38.193	19.978	-10.811
10/28/04	1:53:05	2273.5192	-41.403	38.597	20.382	-10.811
10/28/04	1:55:05	2275.5192	-41.691	38.309	20.094	-10.804
10/28/04	1:57:05	2277.5192	-42.081	37.919	19.704	-10.796
10/28/04	1:59:05	2279.5192	-42.037	37.963	19.748	-10.804
10/28/04	2:01:05	2281.5192	-41.187	38.813	20.598	-10.796
10/28/04	2:03:05	2283.5192	-41.533	38.467	20.252	-10.796

10/28/04	2:05:05	2285.5192	-41.519	38.481	20.266	-10.789
10/28/04	2:07:05	2287.5192	-41.346	38.654	20.439	-10.789
10/28/04	2:09:05	2289.5192	-41.936	38.064	19.849	-10.789
10/28/04	2:11:05	2291.5192	-41.547	38.453	20.238	-10.789
10/28/04	2:13:05	2293.5192	-41.764	38.236	20.021	-10.789
10/28/04	2:15:05	2295.5192	-41.043	38.957	20.742	-10.782
10/28/04	2:17:05	2297.5192	-41.792	38.208	19.993	-10.782
10/28/04	2:19:05	2299.5192	-41.374	38.626	20.411	-10.789
10/28/04	2:21:05	2301.5192	-41.994	38.006	19.791	-10.789
10/28/04	2:23:05	2303.5192	-41.562	38.438	20.223	-10.782
10/28/04	2:25:05	2305.5192	-40.957	39.043	20.828	-10.789
10/28/04	2:27:05	2307.5192	-41.836	38.164	19.949	-10.782
10/28/04	2:29:05	2309.5192	-41.389	38.611	20.396	-10.789
10/28/04	2:31:05	2311.5192	-42.081	37.919	19.704	-10.789
10/28/04	2:33:05	2313.5192	-41.259	38.741	20.526	-10.782
10/28/04	2:35:05	2315.5192	-41.605	38.395	20.180	-10.782
10/28/04	2:37:05	2317.5192	-41.778	38.222	20.007	-10.789
10/28/04	2:39:05	2319.5192	-41.749	38.251	20.036	-10.782
10/28/04	2:41:05	2321.5192	-41.317	38.683	20.468	-10.789
10/28/04	2:43:05	2323.5192	-40.841	39.159	20.944	-10.789
10/28/04	2:45:05	2325.5192	-41.346	38.654	20.439	-10.789
10/28/04	2:47:05	2327.5192	-41.908	38.092	19.877	-10.789
10/28/04	2:49:05	2329.5192	-41.475	38.525	20.310	-10.789
10/28/04	2:51:05	2331.5192	-41.374	38.626	20.411	-10.789
10/28/04	2:53:05	2333.5192	-41.576	38.424	20.209	-10.789
10/28/04	2:55:05	2335.5192	-41.879	38.121	19.906	-10.796
10/28/04	2:57:05	2337.5192	-41.749	38.251	20.036	-10.796
10/28/04	2:59:05	2339.5192	-41.245	38.755	20.540	-10.789
10/28/04	3:01:05	2341.5192	-41.908	38.092	19.877	-10.789
10/28/04	3:03:05	2343.5192	-40.942	39.058	20.843	-10.796
10/28/04	3:05:05	2345.5192	-41.158	38.842	20.627	-10.796
10/28/04	3:07:05	2347.5192	-41.619	38.381	20.166	-10.804
10/28/04	3:09:05	2349.5192	-41.691	38.309	20.094	-10.804
10/28/04	3:11:05	2351.5192	-41.706	38.294	20.079	-10.804
10/28/04	3:13:05	2353.5192	-41.648	38.352	20.137	-10.804
10/28/04	3:15:05	2355.5192	-41.519	38.481	20.266	-10.804
10/28/04	3:17:05	2357.5192	-42.023	37.977	19.762	-10.811
10/28/04	3:19:05	2359.5192	-41.533	38.467	20.252	-10.811
10/28/04	3:21:05	2361.5192	-41.461	38.539	20.324	-10.811
10/28/04	3:23:05	2363.5192	-41.807	38.193	19.978	-10.811
10/28/04	3:25:05	2365.5192	-42.167	37.833	19.618	-10.818
10/28/04	3:27:05	2367.5192	-41.706	38.294	20.079	-10.818
10/28/04	3:29:05	2369.5192	-41.173	38.827	20.612	-10.825
10/28/04	3:31:05	2371.5192	-41.807	38.193	19.978	-10.832
10/28/04	3:33:05	2373.5192	-41.879	38.121	19.906	-10.825
10/28/04	3:35:05	2375.5192	-41.764	38.236	20.021	-10.832
10/28/04	3:37:05	2377.5192	-41.879	38.121	19.906	-10.832
10/28/04	3:39:05	2379.5192	-41.778	38.222	20.007	-10.839
10/28/04	3:41:05	2381.5192	-41.547	38.453	20.238	-10.839
10/28/04	3:43:05	2383.5192	-41.836	38.164	19.949	-10.847
10/28/04	3:45:05	2385.5192	-41.288	38.712	20.497	-10.854
10/28/04	3:47:05	2387.5192	-41.893	38.107	19.892	-10.854
10/28/04	3:49:05	2389.5192	-42.095	37.905	19.690	-10.861
10/28/04	3:51:05	2391.5192	-41.230	38.770	20.555	-10.861
10/28/04	3:53:05	2393.5192	-41.591	38.409	20.194	-10.868
10/28/04	3:55:05	2395.5192	-41.490	38.510	20.295	-10.868

10/28/04	3:57:05	2397.5192	-41.720	38.280	20.065	-10.875
10/28/04	3:59:05	2399.5192	-42.196	37.804	19.589	-10.875
10/28/04	4:01:05	2401.5192	-41.418	38.582	20.367	-10.875
10/28/04	4:03:05	2403.5192	-41.562	38.438	20.223	-10.882
10/28/04	4:05:05	2405.5192	-41.202	38.798	20.583	-10.890
10/28/04	4:07:05	2407.5192	-41.619	38.381	20.166	-10.890
10/28/04	4:09:05	2409.5192	-41.749	38.251	20.036	-10.890
10/28/04	4:11:05	2411.5192	-42.023	37.977	19.762	-10.897
10/28/04	4:13:05	2413.5192	-41.879	38.121	19.906	-10.897
10/28/04	4:15:05	2415.5192	-41.663	38.337	20.122	-10.904
10/28/04	4:17:05	2417.5192	-42.008	37.992	19.777	-10.904
10/28/04	4:19:05	2419.5192	-41.245	38.755	20.540	-10.911
10/28/04	4:21:05	2421.5192	-41.374	38.626	20.411	-10.911
10/28/04	4:23:05	2423.5192	-41.346	38.654	20.439	-10.918
10/28/04	4:25:05	2425.5192	-41.129	38.871	20.656	-10.926
10/28/04	4:27:05	2427.5192	-41.475	38.525	20.310	-10.933
10/28/04	4:29:05	2429.5192	-41.259	38.741	20.526	-10.940
10/28/04	4:31:05	2431.5192	-42.109	37.891	19.676	-10.940
10/28/04	4:33:05	2433.5192	-41.980	38.020	19.805	-10.940
10/28/04	4:35:05	2435.5192	-41.302	38.698	20.483	-10.954
10/28/04	4:37:05	2437.5192	-41.850	38.150	19.935	-10.961
10/28/04	4:39:05	2439.5192	-41.158	38.842	20.627	-10.969
10/28/04	4:41:05	2441.5192	-41.202	38.798	20.583	-10.969
10/28/04	4:43:05	2443.5192	-41.720	38.280	20.065	-10.976
10/28/04	4:45:05	2445.5192	-41.936	38.064	19.849	-10.976
10/28/04	4:47:05	2447.5192	-41.663	38.337	20.122	-10.976
10/28/04	4:49:05	2449.5192	-41.951	38.049	19.834	-10.990
10/28/04	4:51:05	2451.5192	-41.994	38.006	19.791	-10.990
10/28/04	4:53:05	2453.5192	-41.504	38.496	20.281	-11.004
10/28/04	4:55:05	2455.5192	-41.576	38.424	20.209	-11.004
10/28/04	4:57:05	2457.5192	-41.994	38.006	19.791	-11.012
10/28/04	4:59:05	2459.5192	-41.403	38.597	20.382	-11.012
10/28/04	5:01:05	2461.5192	-41.634	38.366	20.151	-11.019
10/28/04	5:03:05	2463.5192	-41.317	38.683	20.468	-11.019
10/28/04	5:05:05	2465.5192	-42.037	37.963	19.748	-11.026
10/28/04	5:07:05	2467.5192	-42.081	37.919	19.704	-11.033
10/28/04	5:09:05	2469.5192	-41.634	38.366	20.151	-11.040
10/28/04	5:11:05	2471.5192	-41.908	38.092	19.877	-11.047
10/28/04	5:13:05	2473.5192	-41.591	38.409	20.194	-11.055
10/28/04	5:15:05	2475.5192	-42.066	37.934	19.719	-11.062
10/28/04	5:17:05	2477.5192	-42.023	37.977	19.762	-11.062
10/28/04	5:19:05	2479.5192	-41.893	38.107	19.892	-11.069
10/28/04	5:21:05	2481.5192	-41.994	38.006	19.791	-11.076
10/28/04	5:23:05	2483.5192	-41.821	38.179	19.964	-11.083
10/28/04	5:25:05	2485.5192	-41.980	38.020	19.805	-11.083
10/28/04	5:27:05	2487.5192	-41.778	38.222	20.007	-11.090
10/28/04	5:29:05	2489.5192	-42.066	37.934	19.719	-11.105
10/28/04	5:31:05	2491.5192	-41.922	38.078	19.863	-11.105
10/28/04	5:33:05	2493.5192	-41.951	38.049	19.834	-11.119
10/28/04	5:35:05	2495.5192	-42.498	37.502	19.287	-11.126
10/28/04	5:37:05	2497.5192	-41.749	38.251	20.036	-11.134
10/28/04	5:39:05	2499.5192	-41.677	38.323	20.108	-11.134
10/28/04	5:41:05	2501.5192	-42.124	37.876	19.661	-11.141
10/28/04	5:43:05	2503.5192	-41.706	38.294	20.079	-11.148
10/28/04	5:45:05	2505.5192	-42.008	37.992	19.777	-11.162
10/28/04	5:47:05	2507.5192	-41.792	38.208	19.993	-11.169

10/28/04	5:49:05	2509.5192	-41.936	38.064	19.849	-11.177
10/28/04	5:51:05	2511.5192	-41.792	38.208	19.993	-11.177
10/28/04	5:53:05	2513.5192	-41.936	38.064	19.849	-11.191
10/28/04	5:55:05	2515.5192	-42.398	37.602	19.387	-11.191
10/28/04	5:57:05	2517.5192	-41.879	38.121	19.906	-11.198
10/28/04	5:59:05	2519.5192	-42.109	37.891	19.676	-11.205
10/28/04	6:01:05	2521.5192	-41.908	38.092	19.877	-11.220
10/28/04	6:03:05	2523.5192	-41.965	38.035	19.820	-11.220
10/28/04	6:05:05	2525.5192	-42.599	37.401	19.186	-11.227
10/28/04	6:07:05	2527.5192	-41.605	38.395	20.180	-11.227
10/28/04	6:09:05	2529.5192	-42.023	37.977	19.762	-11.241
10/28/04	6:11:05	2531.5192	-42.412	37.588	19.373	-11.241
10/28/04	6:13:05	2533.5192	-42.210	37.790	19.575	-11.255
10/28/04	6:15:05	2535.5192	-42.354	37.646	19.431	-11.263
10/28/04	6:17:05	2537.5192	-41.936	38.064	19.849	-11.263
10/28/04	6:19:05	2539.5192	-41.980	38.020	19.805	-11.270
10/28/04	6:21:05	2541.5192	-42.095	37.905	19.690	-11.270
10/28/04	6:23:05	2543.5192	-42.124	37.876	19.661	-11.284
10/28/04	6:25:05	2545.5192	-41.864	38.136	19.921	-11.284
10/28/04	6:27:05	2547.5192	-42.513	37.487	19.272	-11.291
10/28/04	6:29:05	2549.5192	-42.354	37.646	19.431	-11.298
10/28/04	6:31:05	2551.5192	-41.821	38.179	19.964	-11.313
10/28/04	6:33:05	2553.5192	-41.908	38.092	19.877	-11.313
10/28/04	6:35:05	2555.5192	-41.980	38.020	19.805	-11.327
10/28/04	6:37:05	2557.5192	-41.821	38.179	19.964	-11.327
10/28/04	6:39:05	2559.5192	-41.519	38.481	20.266	-11.341
10/28/04	6:41:05	2561.5192	-42.153	37.847	19.632	-11.341
10/28/04	6:43:05	2563.5192	-42.037	37.963	19.748	-11.349
10/28/04	6:45:05	2565.5192	-42.153	37.847	19.632	-11.356
10/28/04	6:47:05	2567.5192	-42.196	37.804	19.589	-11.363
10/28/04	6:49:05	2569.5192	-42.470	37.530	19.315	-11.370
10/28/04	6:51:05	2571.5192	-42.109	37.891	19.676	-11.385
10/28/04	6:53:05	2573.5192	-42.225	37.775	19.560	-11.392
10/28/04	6:55:05	2575.5192	-42.297	37.703	19.488	-11.392
10/28/04	6:57:05	2577.5192	-42.023	37.977	19.762	-11.399
10/28/04	6:59:05	2579.5192	-42.181	37.819	19.604	-11.406
10/28/04	7:01:05	2581.5192	-42.311	37.689	19.474	-11.413
10/28/04	7:03:05	2583.5192	-42.052	37.948	19.733	-11.413
10/28/04	7:05:05	2585.5192	-42.470	37.530	19.315	-11.420
10/28/04	7:07:05	2587.5192	-41.519	38.481	20.266	-11.420
10/28/04	7:09:05	2589.5192	-42.513	37.487	19.272	-11.428
10/28/04	7:11:05	2591.5192	-42.297	37.703	19.488	-11.435
10/28/04	7:13:05	2593.5192	-41.663	38.337	20.122	-11.442
10/28/04	7:15:05	2595.5192	-42.167	37.833	19.618	-11.449
10/28/04	7:17:05	2597.5192	-42.037	37.963	19.748	-11.449
10/28/04	7:19:05	2599.5192	-42.167	37.833	19.618	-11.456
10/28/04	7:21:05	2601.5192	-41.720	38.280	20.065	-11.463
10/28/04	7:23:05	2603.5192	-42.037	37.963	19.748	-11.463
10/28/04	7:25:05	2605.5192	-42.498	37.502	19.287	-11.463
10/28/04	7:27:05	2607.5192	-42.109	37.891	19.676	-11.471
10/28/04	7:29:05	2609.5192	-42.297	37.703	19.488	-11.478
10/28/04	7:31:05	2611.5192	-42.138	37.862	19.647	-11.485
10/28/04	7:33:05	2613.5192	-42.196	37.804	19.589	-11.485
10/28/04	7:35:05	2615.5192	-42.109	37.891	19.676	-11.485
10/28/04	7:37:05	2617.5192	-42.743	37.257	19.042	-11.485
10/28/04	7:39:05	2619.5192	-42.671	37.329	19.114	-11.492

10/28/04	7:41:05	2621.5192	-41.850	38.150	19.935	-11.499
10/28/04	7:43:05	2623.5192	-42.398	37.602	19.387	-11.499
10/28/04	7:45:05	2625.5192	-42.138	37.862	19.647	-11.506
10/28/04	7:47:05	2627.5192	-42.081	37.919	19.704	-11.506
10/28/04	7:49:05	2629.5192	-42.037	37.963	19.748	-11.506
10/28/04	7:51:05	2631.5192	-42.311	37.689	19.474	-11.514
10/28/04	7:53:05	2633.5192	-42.383	37.617	19.402	-11.514
10/28/04	7:55:05	2635.5192	-42.253	37.747	19.532	-11.514
10/28/04	7:57:05	2637.5192	-42.441	37.559	19.344	-11.514
10/28/04	7:59:05	2639.5192	-42.398	37.602	19.387	-11.521
10/28/04	8:01:05	2641.5192	-42.383	37.617	19.402	-11.528
10/28/04	8:03:05	2643.5192	-42.513	37.487	19.272	-11.535
10/28/04	8:05:05	2645.5192	-42.253	37.747	19.532	-11.535
10/28/04	8:07:05	2647.5192	-42.628	37.372	19.157	-11.535
10/28/04	8:09:05	2649.5192	-42.081	37.919	19.704	-11.542
10/28/04	8:11:05	2651.5192	-42.455	37.545	19.330	-11.535
10/28/04	8:13:05	2653.5192	-42.556	37.444	19.229	-11.542
10/28/04	8:15:05	2655.5192	-42.643	37.357	19.142	-11.542
10/28/04	8:17:05	2657.5192	-42.556	37.444	19.229	-11.549
10/28/04	8:19:05	2659.5192	-42.196	37.804	19.589	-11.549
10/28/04	8:21:05	2661.5192	-42.023	37.977	19.762	-11.549
10/28/04	8:23:05	2663.5192	-42.124	37.876	19.661	-11.549
10/28/04	8:25:05	2665.5192	-42.326	37.674	19.459	-11.549
10/28/04	8:27:05	2667.5192	-42.787	37.213	18.998	-11.571
10/28/04	8:29:05	2669.5192	-42.484	37.516	19.301	-11.571
10/28/04	8:31:05	2671.5192	-42.585	37.415	19.200	-11.557
10/28/04	8:33:05	2673.5192	-42.801	37.199	18.984	-11.571
10/28/04	8:35:05	2675.5192	-42.614	37.386	19.171	-11.571
10/28/04	8:37:05	2677.5192	-42.743	37.257	19.042	-11.571
10/28/04	8:39:05	2679.5192	-42.311	37.689	19.474	-11.564
10/28/04	8:41:05	2681.5192	-42.398	37.602	19.387	-11.564
10/28/04	8:43:05	2683.5192	-42.354	37.646	19.431	-11.564
10/28/04	8:45:05	2685.5192	-42.311	37.689	19.474	-11.571
10/28/04	8:47:05	2687.5192	-42.008	37.992	19.777	-11.571
10/28/04	8:49:05	2689.5192	-42.657	37.343	19.128	-11.578
10/28/04	8:51:05	2691.5192	-42.441	37.559	19.344	-11.571
10/28/04	8:53:05	2693.5192	-42.124	37.876	19.661	-11.578
10/28/04	8:55:05	2695.5192	-42.239	37.761	19.546	-11.571
10/28/04	8:57:05	2697.5192	-42.470	37.530	19.315	-11.571
10/28/04	8:59:05	2699.5192	-42.441	37.559	19.344	-11.578
10/28/04	9:01:05	2701.5192	-42.225	37.775	19.560	-11.571
10/28/04	9:03:05	2703.5192	-42.138	37.862	19.647	-11.564
10/28/04	9:05:05	2705.5192	-42.542	37.458	19.243	-11.564
10/28/04	9:07:05	2707.5192	-42.052	37.948	19.733	-11.564
10/28/04	9:09:05	2709.5192	-42.052	37.948	19.733	-11.564
10/28/04	9:11:05	2711.5192	-42.527	37.473	19.258	-11.564
10/28/04	9:13:05	2713.5192	-42.671	37.329	19.114	-11.564
10/28/04	9:15:05	2715.5192	-42.066	37.934	19.719	-11.571
10/28/04	9:17:05	2717.5192	-42.109	37.891	19.676	-11.564
10/28/04	9:19:05	2719.5192	-42.758	37.242	19.027	-11.557
10/28/04	9:21:05	2721.5192	-41.864	38.136	19.921	-11.564
10/28/04	9:23:05	2723.5192	-42.729	37.271	19.056	-11.557
10/28/04	9:25:05	2725.5192	-42.383	37.617	19.402	-11.557
10/28/04	9:27:05	2727.5192	-42.052	37.948	19.733	-11.557
10/28/04	9:29:05	2729.5192	-42.383	37.617	19.402	-11.557
10/28/04	9:31:05	2731.5192	-42.729	37.271	19.056	-11.557

10/28/04	9:33:05	2733.5192	-42.210	37.790	19.575	-11.549
10/28/04	9:35:05	2735.5192	-42.787	37.213	18.998	-11.549
10/28/04	9:37:05	2737.5192	-42.037	37.963	19.748	-11.542
10/28/04	9:39:05	2739.5192	-42.282	37.718	19.503	-11.542
10/28/04	9:41:05	2741.5192	-42.498	37.502	19.287	-11.542
10/28/04	9:43:05	2743.5192	-42.412	37.588	19.373	-11.535
10/28/04	9:45:05	2745.5192	-42.196	37.804	19.589	-11.535
10/28/04	9:47:05	2747.5192	-42.196	37.804	19.589	-11.528
10/28/04	9:49:05	2749.5192	-41.764	38.236	20.021	-11.528
10/28/04	9:51:05	2751.5192	-41.994	38.006	19.791	-11.528
10/28/04	9:53:05	2753.5192	-42.585	37.415	19.200	-11.521
10/28/04	9:55:05	2755.5192	-41.288	38.712	20.497	-11.514
10/28/04	9:57:05	2757.5192	-42.340	37.660	19.445	-11.514
10/28/04	9:59:05	2759.5192	-42.282	37.718	19.503	-11.506
10/28/04	10:01:05	2761.5192	-41.778	38.222	20.007	-11.506
10/28/04	10:03:05	2763.5192	-42.239	37.761	19.546	-11.506
10/28/04	10:05:05	2765.5192	-42.138	37.862	19.647	-11.506
10/28/04	10:07:05	2767.5192	-42.196	37.804	19.589	-11.499
10/28/04	10:09:05	2769.5192	-42.109	37.891	19.676	-11.492
10/28/04	10:11:05	2771.5192	-42.354	37.646	19.431	-11.492
10/28/04	10:13:05	2773.5192	-42.282	37.718	19.503	-11.492
10/28/04	10:15:05	2775.5192	-42.815	37.185	18.970	-11.485
10/28/04	10:17:05	2777.5192	-42.239	37.761	19.546	-11.478
10/28/04	10:19:05	2779.5192	-41.879	38.121	19.906	-11.478
10/28/04	10:21:05	2781.5192	-42.311	37.689	19.474	-11.463
10/28/04	10:23:05	2783.5192	-42.081	37.919	19.704	-11.471
10/28/04	10:25:05	2785.5192	-42.484	37.516	19.301	-11.463
10/28/04	10:27:05	2787.5192	-42.484	37.516	19.301	-11.449
10/28/04	10:29:05	2789.5192	-42.455	37.545	19.330	-11.449
10/28/04	10:31:05	2791.5192	-42.167	37.833	19.618	-11.442
10/28/04	10:33:05	2793.5192	-41.764	38.236	20.021	-11.420
10/28/04	10:35:05	2795.5192	-42.556	37.444	19.229	-11.420
10/28/04	10:37:05	2797.5192	-41.908	38.092	19.877	-11.428
10/28/04	10:39:05	2799.5192	-42.138	37.862	19.647	-11.428
10/28/04	10:41:05	2801.5192	-42.412	37.588	19.373	-11.406
10/28/04	10:43:05	2803.5192	-41.562	38.438	20.223	-11.406
10/28/04	10:45:05	2805.5192	-41.634	38.366	20.151	-11.399
10/28/04	10:47:05	2807.5192	-42.081	37.919	19.704	-11.399
10/28/04	10:49:05	2809.5192	-42.081	37.919	19.704	-11.392
10/28/04	10:51:05	2811.5192	-41.908	38.092	19.877	-11.385
10/28/04	10:53:05	2813.5192	-42.297	37.703	19.488	-11.377
10/28/04	10:55:05	2815.5192	-42.484	37.516	19.301	-11.385
10/28/04	10:57:05	2817.5192	-41.619	38.381	20.166	-11.370
10/28/04	10:59:05	2819.5192	-42.729	37.271	19.056	-11.363
10/28/04	11:01:05	2821.5192	-42.153	37.847	19.632	-11.349
10/28/04	11:03:05	2823.5192	-41.836	38.164	19.949	-11.341
10/28/04	11:05:05	2825.5192	-42.470	37.530	19.315	-11.341
10/28/04	11:07:05	2827.5192	-42.398	37.602	19.387	-11.334
10/28/04	11:09:05	2829.5192	-42.441	37.559	19.344	-11.327
10/28/04	11:11:05	2831.5192	-41.792	38.208	19.993	-11.320
10/28/04	11:13:05	2833.5192	-41.807	38.193	19.978	-11.313
10/28/04	11:15:05	2835.5192	-42.210	37.790	19.575	-11.306
10/28/04	11:17:05	2837.5192	-42.470	37.530	19.315	-11.298
10/28/04	11:19:05	2839.5192	-42.801	37.199	18.984	-11.291
10/28/04	11:21:05	2841.5192	-42.311	37.689	19.474	-11.284
10/28/04	11:23:05	2843.5192	-41.836	38.164	19.949	-11.284

10/28/04	11:25:05	2845.5192	-42.369	37.631	19.416	-11.270
10/28/04	11:27:05	2847.5192	-42.484	37.516	19.301	-11.270
10/28/04	11:29:05	2849.5192	-41.951	38.049	19.834	-11.263
10/28/04	11:31:05	2851.5192	-42.153	37.847	19.632	-11.255
10/28/04	11:33:05	2853.5192	-41.922	38.078	19.863	-11.234
10/28/04	11:35:05	2855.5192	-41.764	38.236	20.021	-11.241
10/28/04	11:37:05	2857.5192	-41.792	38.208	19.993	-11.234
10/28/04	11:39:05	2859.5192	-42.008	37.992	19.777	-11.227
10/28/04	11:41:05	2861.5192	-41.778	38.222	20.007	-11.220
10/28/04	11:43:05	2863.5192	-41.706	38.294	20.079	-11.205
10/28/04	11:45:05	2865.5192	-42.066	37.934	19.719	-11.198
10/28/04	11:47:05	2867.5192	-41.418	38.582	20.367	-11.191
10/28/04	11:49:05	2869.5192	-42.297	37.703	19.488	-11.184
10/28/04	11:51:05	2871.5192	-41.994	38.006	19.791	-11.184
10/28/04	11:53:05	2873.5192	-42.210	37.790	19.575	-11.169
10/28/04	11:55:05	2875.5192	-41.576	38.424	20.209	-11.169
10/28/04	11:57:05	2877.5192	-41.677	38.323	20.108	-11.162
10/28/04	11:59:05	2879.5192	-41.591	38.409	20.194	-11.155
10/28/04	12:01:05	2881.5192	-42.369	37.631	19.416	-11.141
10/28/04	12:03:05	2883.5192	-42.282	37.718	19.503	-11.126

<u>Chan[3]</u> <u>Feet H2O</u>	<u>TW Orville</u> <u>Drawdown (ft)</u>	<u>Chan[0]</u> <u>Inches Hg</u>
17.294	0.001	30.200
17.294	0.001	30.202
17.294	0.001	30.202
17.294	0.001	30.202
17.294	0.001	30.202
17.294	0.001	30.204
17.294	0.001	30.206
17.294	0.001	30.204
17.294	0.001	30.200
17.294	0.001	30.204
17.287	0.008	30.204
17.294	0.001	30.202
17.287	0.008	30.202
17.294	0.001	30.202
17.294	0.001	30.202
17.294	0.001	30.204
17.294	0.001	30.204
17.287	0.008	30.204
17.294	0.001	30.204
17.294	0.001	30.206
17.294	0.001	30.206
17.294	0.001	30.204
17.294	0.001	30.204
17.287	0.008	30.208
17.273	0.022	30.206
17.237	0.058	30.202
17.201	0.094	30.208
17.129	0.166	30.206
17.029	0.266	30.204
16.9	0.395	30.206
16.742	0.553	30.202
16.641	0.654	30.204
16.347	0.948	30.206
16.154	1.141	30.208
15.96	1.335	30.208
15.781	1.514	30.208
15.63	1.665	30.206
15.48	1.815	30.208
15.358	1.937	30.206
15.236	2.059	30.204
15.121	2.174	30.208
15.013	2.282	30.206
14.92	2.375	30.204
14.827	2.468	30.206
14.741	2.554	30.208
14.662	2.633	30.206
14.583	2.712	30.208
14.519	2.776	30.204
14.454	2.841	30.204
14.389	2.906	30.206
14.318	2.977	30.206
14.268	3.027	30.206

14.203	3.092	30.208
14.153	3.142	30.206
14.103	3.192	30.202
14.06	3.235	30.202
14.024	3.271	30.208
13.966	3.329	30.206
13.931	3.364	30.204
13.895	3.400	30.206
13.852	3.443	30.204
13.823	3.472	30.206
13.787	3.508	30.208
13.744	3.551	30.208
13.723	3.572	30.208
13.694	3.601	30.212
13.658	3.637	30.210
13.629	3.666	30.212
13.608	3.687	30.212
13.579	3.716	30.212
13.558	3.737	30.174
13.529	3.766	30.174
13.5	3.795	30.178
13.479	3.816	30.174
13.443	3.852	30.165
13.428	3.867	30.167
13.407	3.888	30.163
13.378	3.917	30.161
13.357	3.938	30.159
13.328	3.967	30.161
13.307	3.988	30.161
13.285	4.010	30.161
13.264	4.031	30.163
13.249	4.046	30.161
13.22	4.075	30.161
13.206	4.089	30.163
13.17	4.125	30.163
13.156	4.139	30.161
13.12	4.175	30.163
13.099	4.196	30.161
13.027	4.268	30.163
12.977	4.318	30.159
12.955	4.340	30.161
12.912	4.383	30.161
12.891	4.404	30.161
12.869	4.426	30.165
12.833	4.462	30.163
12.812	4.483	30.165
12.783	4.512	30.159
12.769	4.526	30.161
12.733	4.562	30.159
12.704	4.591	30.206
12.683	4.612	30.210
12.661	4.634	30.169
12.632	4.663	30.157
12.618	4.677	30.161
12.589	4.706	30.161
12.575	4.720	30.159

12.561	4.734	30.157
12.532	4.763	30.157
12.51	4.785	30.157
12.489	4.806	30.159
12.475	4.820	30.155
12.446	4.849	30.194
12.432	4.863	30.202
12.424	4.871	30.151
12.403	4.892	30.149
12.389	4.906	30.151
12.381	4.914	30.153
12.374	4.921	30.149
12.353	4.942	30.151
12.346	4.949	30.151
12.331	4.964	30.147
12.317	4.978	30.145
12.31	4.985	30.147
12.302	4.993	30.145
12.288	5.007	30.147
12.274	5.021	30.145
12.274	5.021	30.143
12.252	5.043	30.145
12.245	5.050	30.141
12.238	5.057	30.143
12.231	5.064	30.143
12.224	5.071	30.141
12.209	5.086	30.141
12.209	5.086	30.143
12.195	5.100	30.141
12.188	5.107	30.139
12.188	5.107	30.139
12.173	5.122	30.139
12.159	5.136	30.139
12.159	5.136	30.143
12.152	5.143	30.137
12.145	5.150	30.139
12.145	5.150	30.137
12.138	5.157	30.137
12.13	5.165	30.133
12.13	5.165	30.135
12.116	5.179	30.135
12.116	5.179	30.135
12.109	5.186	30.133
12.109	5.186	30.133
12.102	5.193	30.133
12.095	5.200	30.135
12.095	5.200	30.135
12.095	5.200	30.139
12.095	5.200	30.135
12.08	5.215	30.182
12.066	5.229	30.184
12.073	5.222	30.133
12.059	5.236	30.133
12.073	5.222	30.135
12.059	5.236	30.135
12.059	5.236	30.135

12.059	5.236	30.137
12.051	5.244	30.135
12.059	5.236	30.131
12.051	5.244	30.135
12.051	5.244	30.135
12.044	5.251	30.135
12.044	5.251	30.131
12.037	5.258	30.137
12.037	5.258	30.135
12.03	5.265	30.135
12.03	5.265	30.133
12.03	5.265	30.133
12.03	5.265	30.135
12.037	5.258	30.133
12.03	5.265	30.133
12.03	5.265	30.133
12.03	5.265	30.137
12.03	5.265	30.133
12.037	5.258	30.135
12.03	5.265	30.133
12.037	5.258	30.135
12.037	5.258	30.133
12.03	5.265	30.133
12.037	5.258	30.137
12.03	5.265	30.139
12.037	5.258	30.139
12.037	5.258	30.135
12.03	5.265	30.135
12.03	5.265	30.133
12.037	5.258	30.137
12.037	5.258	30.139
12.037	5.258	30.137
12.044	5.251	30.139
12.037	5.258	30.139
12.044	5.251	30.139
12.044	5.251	30.139
12.051	5.244	30.139
12.044	5.251	30.139
12.044	5.251	30.139
12.051	5.244	30.137
12.051	5.244	30.135
12.059	5.236	30.133
12.059	5.236	30.137
12.073	5.222	30.135
12.073	5.222	30.139
12.059	5.236	30.135
12.08	5.215	30.137
12.08	5.215	30.135
12.08	5.215	30.137
12.08	5.215	30.137
12.08	5.215	30.137
12.087	5.208	30.135
12.095	5.200	30.137
12.102	5.193	30.139
12.109	5.186	30.135
12.109	5.186	30.137

12.109	5.186	30.135
12.116	5.179	30.131
12.123	5.172	30.135
12.123	5.172	30.133
12.123	5.172	30.133
12.13	5.165	30.131
12.13	5.165	30.133
12.138	5.157	30.135
12.145	5.150	30.135
12.145	5.150	30.131
12.145	5.150	30.131
12.152	5.143	30.131
12.152	5.143	30.131
12.152	5.143	30.131
12.159	5.136	30.131
12.166	5.129	30.133
12.173	5.122	30.131
12.181	5.114	30.133
12.173	5.122	30.133
12.181	5.114	30.131
12.181	5.114	30.133
12.188	5.107	30.133
12.195	5.100	30.133
12.202	5.093	30.133
12.202	5.093	30.129
12.202	5.093	30.131
12.209	5.086	30.129
12.209	5.086	30.131
12.216	5.079	30.129
12.216	5.079	30.131
12.224	5.071	30.131
12.224	5.071	30.131
12.231	5.064	30.133
12.231	5.064	30.182
12.231	5.064	30.184
12.238	5.057	30.192
12.252	5.043	30.190
12.252	5.043	30.149
12.259	5.036	30.149
12.259	5.036	30.143
12.259	5.036	30.141
12.267	5.028	30.141
12.274	5.021	30.139
12.274	5.021	30.139
12.274	5.021	30.139
12.281	5.014	30.139
12.281	5.014	30.139
12.288	5.007	30.139
12.295	5.000	30.141
12.295	5.000	30.137
12.281	5.014	30.137
12.288	5.007	30.139
12.288	5.007	30.139
12.295	5.000	30.139
12.295	5.000	30.137
12.302	4.993	30.137

12.302	4.993	30.139
12.31	4.985	30.139
12.31	4.985	30.141
12.31	4.985	30.139
12.317	4.978	30.137
12.324	4.971	30.139
12.324	4.971	30.141
12.324	4.971	30.141
12.324	4.971	30.139
12.324	4.971	30.143
12.331	4.964	30.145
12.338	4.957	30.145
12.331	4.964	30.145
12.331	4.964	30.147
12.338	4.957	30.145
12.331	4.964	30.147
12.338	4.957	30.149
12.338	4.957	30.147
12.346	4.949	30.149
12.346	4.949	30.151
12.346	4.949	30.151
12.338	4.957	30.151
12.338	4.957	30.153
12.338	4.957	30.155
12.346	4.949	30.157
12.346	4.949	30.155
12.346	4.949	30.157
12.338	4.957	30.155
12.353	4.942	30.157
12.346	4.949	30.157
12.346	4.949	30.159
12.346	4.949	30.157
12.346	4.949	30.157
12.346	4.949	30.155
12.338	4.957	30.155
12.338	4.957	30.155
12.338	4.957	30.153
12.331	4.964	30.155
12.338	4.957	30.155
12.338	4.957	30.157
12.338	4.957	30.157
12.331	4.964	30.157
12.331	4.964	30.159
12.331	4.964	30.161
12.331	4.964	30.159
12.324	4.971	30.159
12.324	4.971	30.159
12.324	4.971	30.159
12.317	4.978	30.159
12.317	4.978	30.159
12.31	4.985	30.157
12.31	4.985	30.159
12.31	4.985	30.159
12.31	4.985	30.159
12.302	4.993	30.159
12.302	4.993	30.161

12.302	4.993	30.159
12.295	5.000	30.163
12.295	5.000	30.163
12.288	5.007	30.165
12.281	5.014	30.165
12.281	5.014	30.165
12.281	5.014	30.165
12.274	5.021	30.165
12.274	5.021	30.165
12.274	5.021	30.165
12.259	5.036	30.165
12.259	5.036	30.165
12.259	5.036	30.165
12.252	5.043	30.167
12.252	5.043	30.169
12.245	5.050	30.167
12.231	5.064	30.167
12.224	5.071	30.169
12.216	5.079	30.169
12.209	5.086	30.169
12.209	5.086	30.169
12.202	5.093	30.169
12.202	5.093	30.169
12.195	5.100	30.167
12.188	5.107	30.167
12.195	5.100	30.167
12.188	5.107	30.167
12.181	5.114	30.169
12.173	5.122	30.171
12.173	5.122	30.171
12.166	5.129	30.169
12.152	5.143	30.171
12.159	5.136	30.171
12.145	5.150	30.171
12.145	5.150	30.171
12.138	5.157	30.174
12.13	5.165	30.174
12.13	5.165	30.171
12.116	5.179	30.171
12.109	5.186	30.171
12.109	5.186	30.174
12.109	5.186	30.174
12.095	5.200	30.174
12.087	5.208	30.174
12.08	5.215	30.174
12.08	5.215	30.171
12.059	5.236	30.174
12.059	5.236	30.174
12.051	5.244	30.174
12.044	5.251	30.176
12.037	5.258	30.176
12.03	5.265	30.180
12.023	5.272	30.178
12.008	5.287	30.178
12.008	5.287	30.180
12.008	5.287	30.180

11.994	5.301	30.180
11.98	5.315	30.182
11.973	5.322	30.182
11.973	5.322	30.184
11.965	5.330	30.182
11.958	5.337	30.184
11.951	5.344	30.184
11.944	5.351	30.182
11.937	5.358	30.184
11.93	5.365	30.182
11.922	5.373	30.182
11.915	5.380	30.180
11.908	5.387	30.182
11.901	5.394	30.182
11.894	5.401	30.184
11.879	5.416	30.180
11.865	5.430	30.182
11.858	5.437	30.182
11.851	5.444	30.184
11.844	5.451	30.184
11.836	5.459	30.182
11.822	5.473	30.182
11.815	5.480	30.182
11.815	5.480	30.180
11.808	5.487	30.180
11.8	5.495	30.180
11.793	5.502	30.182
11.779	5.516	30.178
11.772	5.523	30.180
11.772	5.523	30.178
11.765	5.530	30.178
11.75	5.545	30.180
11.75	5.545	30.182
11.743	5.552	30.178
11.736	5.559	30.180
11.729	5.566	30.178
11.714	5.581	30.178
11.714	5.581	30.176
11.693	5.602	30.174
11.693	5.602	30.174
11.679	5.616	30.171
11.671	5.624	30.169
11.671	5.624	30.167
11.664	5.631	30.163
11.65	5.645	30.163
11.643	5.652	30.161
11.636	5.659	30.161
11.628	5.667	30.161
11.621	5.674	30.161
11.621	5.674	30.161
11.607	5.688	30.157
11.6	5.695	30.157
11.592	5.703	30.157
11.585	5.710	30.157
11.578	5.717	30.157
11.571	5.724	30.159

11.564	5.731	30.157
11.557	5.738	30.157
11.549	5.746	30.157
11.542	5.753	30.155
11.535	5.760	30.157
11.521	5.774	30.155
11.506	5.789	30.155
11.499	5.796	30.157
11.499	5.796	30.157
11.492	5.803	30.157
11.485	5.810	30.159
11.478	5.817	30.157
11.471	5.824	30.157
11.463	5.832	30.157
11.456	5.839	30.157
11.449	5.846	30.159
11.442	5.853	30.157
11.435	5.860	30.157
11.442	5.853	30.155
11.428	5.867	30.155
11.428	5.867	30.153
11.413	5.882	30.155
11.413	5.882	30.155
11.406	5.889	30.155
11.406	5.889	30.155
11.399	5.896	30.153
11.392	5.903	30.155
11.385	5.910	30.153
11.377	5.918	30.153
11.377	5.918	30.153
11.37	5.925	30.153
11.363	5.932	30.151
11.363	5.932	30.151
11.363	5.932	30.151
11.356	5.939	30.151
11.349	5.946	30.151
11.349	5.946	30.151
11.341	5.954	30.149
11.341	5.954	30.153
11.327	5.968	30.149
11.327	5.968	30.149
11.327	5.968	30.149
11.32	5.975	30.153
11.313	5.982	30.151
11.313	5.982	30.149
11.313	5.982	30.149
11.313	5.982	30.147
11.306	5.989	30.147
11.298	5.997	30.147
11.306	5.989	30.149
11.298	5.997	30.147
11.291	6.004	30.147
11.291	6.004	30.147
11.291	6.004	30.149
11.291	6.004	30.147
11.291	6.004	30.145

11.284	6.011	30.145
11.284	6.011	30.147
11.284	6.011	30.145
11.291	6.004	30.147
11.284	6.011	30.149
11.284	6.011	30.151
11.277	6.018	30.147
11.284	6.011	30.147
11.277	6.018	30.147
11.277	6.018	30.147
11.277	6.018	30.145
11.277	6.018	30.147
11.277	6.018	30.147
11.277	6.018	30.147
11.277	6.018	30.145
11.277	6.018	30.147
11.277	6.018	30.147
11.277	6.018	30.149
11.277	6.018	30.151
11.277	6.018	30.149
11.277	6.018	30.147
11.277	6.018	30.147
11.284	6.011	30.145
11.284	6.011	30.147
11.284	6.011	30.147
11.284	6.011	30.145
11.284	6.011	30.143
11.291	6.004	30.143
11.291	6.004	30.143
11.291	6.004	30.141
11.291	6.004	30.143
11.291	6.004	30.143
11.291	6.004	30.145
11.291	6.004	30.145
11.291	6.004	30.145
11.291	6.004	30.141
11.291	6.004	30.141
11.298	5.997	30.141
11.298	5.997	30.139
11.298	5.997	30.139
11.298	5.997	30.139
11.306	5.989	30.137
11.306	5.989	30.139
11.306	5.989	30.139
11.306	5.989	30.139
11.313	5.982	30.137
11.313	5.982	30.139
11.313	5.982	30.139
11.32	5.975	30.139
11.32	5.975	30.139
11.32	5.975	30.139
11.32	5.975	30.139
11.327	5.968	30.141
11.327	5.968	30.141
11.334	5.961	30.139
11.334	5.961	30.139
11.341	5.954	30.139

11.341	5.954	30.139
11.349	5.946	30.137
11.356	5.939	30.137
11.356	5.939	30.135
11.356	5.939	30.133
11.363	5.932	30.133
11.363	5.932	30.133
11.377	5.918	30.133
11.377	5.918	30.131
11.385	5.910	30.131
11.385	5.910	30.131
11.392	5.903	30.129
11.399	5.896	30.129
11.399	5.896	30.127
11.406	5.889	30.129
11.406	5.889	30.129
11.413	5.882	30.129
11.42	5.875	30.131
11.42	5.875	30.131
11.428	5.867	30.131
11.442	5.853	30.127
11.456	5.839	30.127
11.456	5.839	30.129
11.463	5.832	30.127
11.463	5.832	30.129
11.471	5.824	30.129
11.478	5.817	30.131
11.485	5.810	30.131
11.492	5.803	30.131
11.492	5.803	30.129
11.499	5.796	30.131
11.506	5.789	30.129
11.506	5.789	30.131
11.514	5.781	30.133
11.521	5.774	30.133
11.528	5.767	30.135
11.528	5.767	30.135
11.535	5.760	30.137
11.549	5.746	30.137
11.549	5.746	30.139
11.557	5.738	30.139
11.564	5.731	30.137
11.564	5.731	30.137
11.578	5.717	30.137
11.571	5.724	30.141
11.585	5.710	30.141
11.592	5.703	30.137
11.6	5.695	30.141
11.607	5.688	30.141
11.607	5.688	30.139
11.614	5.681	30.141
11.621	5.674	30.141
11.621	5.674	30.143
11.628	5.667	30.143
11.636	5.659	30.141
11.643	5.652	30.141

11.643	5.652	30.143
11.65	5.645	30.141
11.657	5.638	30.141
11.664	5.631	30.141
11.664	5.631	30.141
11.679	5.616	30.141
11.679	5.616	30.145
11.686	5.609	30.147
11.7	5.595	30.149
11.7	5.595	30.149
11.714	5.581	30.147
11.722	5.573	30.147
11.729	5.566	30.145
11.736	5.559	30.143
11.743	5.552	30.143
11.75	5.545	30.145
11.757	5.538	30.147
11.757	5.538	30.149
11.765	5.530	30.151
11.772	5.523	30.149
11.779	5.516	30.149
11.786	5.509	30.149
11.793	5.502	30.149
11.793	5.502	30.149
11.8	5.495	30.149
11.808	5.487	30.147
11.815	5.480	30.149
11.822	5.473	30.147
11.822	5.473	30.147
11.829	5.466	30.151
11.829	5.466	30.151
11.836	5.459	30.151
11.836	5.459	30.149
11.844	5.451	30.151
11.844	5.451	30.151
11.851	5.444	30.151
11.858	5.437	30.153
11.865	5.430	30.155
11.865	5.430	30.155
11.872	5.423	30.155
11.865	5.430	30.204
11.879	5.416	30.208
11.887	5.408	30.155
11.894	5.401	30.153
11.894	5.401	30.151
11.901	5.394	30.155
11.901	5.394	30.155
11.901	5.394	30.153
11.894	5.401	30.153
11.908	5.387	30.153
11.901	5.394	30.155
11.915	5.380	30.151
11.908	5.387	30.151
11.922	5.373	30.151
11.922	5.373	30.153
11.93	5.365	30.153

11.93	5.365	30.151
11.937	5.358	30.151
11.922	5.373	30.153
11.922	5.373	30.155
11.937	5.358	30.157
11.937	5.358	30.157
11.93	5.365	30.157
11.944	5.351	30.157
11.944	5.351	30.157
11.944	5.351	30.155
11.944	5.351	30.155
11.944	5.351	30.155
11.951	5.344	30.157
11.944	5.351	30.155
11.944	5.351	30.210
11.944	5.351	30.210
11.937	5.358	30.216
11.937	5.358	30.216
11.937	5.358	30.216
11.937	5.358	30.222
11.944	5.351	30.184
11.937	5.358	30.180
11.937	5.358	30.174
11.937	5.358	30.171
11.937	5.358	30.169
11.937	5.358	30.222
11.944	5.351	30.178
11.937	5.358	30.174
11.93	5.365	30.174
11.937	5.358	30.174
11.937	5.358	30.176
11.937	5.358	30.176
11.93	5.365	30.176
11.937	5.358	30.178
11.93	5.365	30.178
11.93	5.365	30.178
11.937	5.358	30.178
11.922	5.373	30.178
11.93	5.365	30.180
11.922	5.373	30.180
11.922	5.373	30.180
11.915	5.380	30.180
11.915	5.380	30.180
11.915	5.380	30.182
11.915	5.380	30.184
11.908	5.387	30.184
11.908	5.387	30.184
11.908	5.387	30.186
11.901	5.394	30.190
11.901	5.394	30.190
11.901	5.394	30.188
11.894	5.401	30.190
11.894	5.401	30.192
11.894	5.401	30.192
11.887	5.408	30.194
11.887	5.408	30.192

11.887	5.408	30.196
11.879	5.416	30.196
11.872	5.423	30.194
11.872	5.423	30.196
11.865	5.430	30.194
11.865	5.430	30.196
11.858	5.437	30.196
11.858	5.437	30.196
11.844	5.451	30.194
11.836	5.459	30.196
11.829	5.466	30.194
11.829	5.466	30.196
11.829	5.466	30.196
11.829	5.466	30.196
11.822	5.473	30.196
11.808	5.487	30.196
11.808	5.487	30.198
11.8	5.495	30.198
11.8	5.495	30.198
11.793	5.502	30.196
11.786	5.509	30.198
11.786	5.509	30.196
11.779	5.516	30.196
11.779	5.516	30.196
11.765	5.530	30.194
11.757	5.538	30.196
11.757	5.538	30.198
11.75	5.545	30.196
11.75	5.545	30.196
11.736	5.559	30.196
11.729	5.566	30.198
11.722	5.573	30.200
11.714	5.581	30.200
11.707	5.588	30.200
11.707	5.588	30.198
11.7	5.595	30.202
11.686	5.609	30.198
11.686	5.609	30.200
11.679	5.616	30.202
11.679	5.616	30.202
11.671	5.624	30.200
11.657	5.638	30.255
11.65	5.645	30.247
11.65	5.645	30.194
11.636	5.659	30.247
11.636	5.659	30.245
11.621	5.674	30.245
11.621	5.674	30.249
11.614	5.681	30.192
11.607	5.688	30.196
11.607	5.688	30.196
11.592	5.703	30.198
11.585	5.710	30.198
11.585	5.710	30.196
11.578	5.717	30.196
11.564	5.731	30.200

11.557	5.738	30.198
11.549	5.746	30.198
11.549	5.746	30.196
11.542	5.753	30.194
11.535	5.760	30.192
11.521	5.774	30.192
11.514	5.781	30.194
11.506	5.789	30.196
11.499	5.796	30.198
11.492	5.803	30.194
11.485	5.810	30.198
11.463	5.832	30.243
11.456	5.839	30.247
11.449	5.846	30.198
11.449	5.846	30.198
11.442	5.853	30.196
11.428	5.867	30.196
11.428	5.867	30.196
11.413	5.882	30.192
11.406	5.889	30.192
11.399	5.896	30.190
11.392	5.903	30.190
11.377	5.918	30.194
11.363	5.932	30.196
11.356	5.939	30.196
11.349	5.946	30.194
11.349	5.946	30.198
11.334	5.961	30.202
11.327	5.968	30.202
11.32	5.975	30.202
11.32	5.975	30.206
11.313	5.982	30.202
11.298	5.997	30.202
11.306	5.989	30.206
11.291	6.004	30.204
11.284	6.011	30.204
11.277	6.018	30.200
11.27	6.025	30.198
11.263	6.032	30.196
11.255	6.040	30.196
11.255	6.040	30.196
11.255	6.040	30.190
11.234	6.061	30.192
11.234	6.061	30.190
11.227	6.068	30.192
11.212	6.083	30.192
11.205	6.090	30.192
11.198	6.097	30.190
11.198	6.097	30.190
11.191	6.104	30.186
11.184	6.111	30.186
11.177	6.118	30.190
11.169	6.126	30.184
11.155	6.140	30.182
11.155	6.140	30.182
11.155	6.140	30.180

11.148	6.147	30.180
11.148	6.147	30.178
11.134	6.161	30.178
11.134	6.161	30.178
11.126	6.169	30.176
11.126	6.169	30.176
11.105	6.190	30.178
11.098	6.197	30.174
11.112	6.183	30.176
11.09	6.205	30.176
11.083	6.212	30.174
11.083	6.212	30.174
11.076	6.219	30.174
11.076	6.219	30.174
11.069	6.226	30.176
11.062	6.233	30.176
11.062	6.233	30.178
11.047	6.248	30.174
11.047	6.248	30.171
11.033	6.262	30.174
11.033	6.262	30.169
11.026	6.269	30.171
11.026	6.269	30.169
11.019	6.276	30.169
11.026	6.269	30.169
11.026	6.269	30.163
11.019	6.276	30.159
11.012	6.283	30.157
11.012	6.283	30.157
11.012	6.283	30.155
11.004	6.291	30.157
11.004	6.291	30.157
10.997	6.298	30.159
10.997	6.298	30.159
10.99	6.305	30.161
10.997	6.298	30.159
10.983	6.312	30.165
10.983	6.312	30.163
10.976	6.319	30.167
10.976	6.319	30.165
10.976	6.319	30.167
10.969	6.326	30.167
10.969	6.326	30.167
10.969	6.326	30.169
10.969	6.326	30.169
10.976	6.319	30.167
10.969	6.326	30.167
10.961	6.334	30.167
10.961	6.334	30.167
10.961	6.334	30.167
10.961	6.334	30.167
10.961	6.334	30.165
10.961	6.334	30.171
10.961	6.334	30.167
10.961	6.334	30.169
10.961	6.334	30.171

10.961	6.334	30.171
10.961	6.334	30.167
10.969	6.326	30.169
10.969	6.326	30.169
10.969	6.326	30.167
10.976	6.319	30.169
10.969	6.326	30.169
10.969	6.326	30.169
10.976	6.319	30.165
10.969	6.326	30.167
10.976	6.319	30.167
10.976	6.319	30.169
10.969	6.326	30.167
10.969	6.326	30.167
10.969	6.326	30.167
10.976	6.319	30.165
10.976	6.319	30.167
10.976	6.319	30.169
10.976	6.319	30.169
10.976	6.319	30.167
10.983	6.312	30.167
10.983	6.312	30.167
10.983	6.312	30.167
10.99	6.305	30.165
10.99	6.305	30.167
10.99	6.305	30.167
10.997	6.298	30.165
10.997	6.298	30.165
10.997	6.298	30.165
10.997	6.298	30.165
10.997	6.298	30.167
11.004	6.291	30.167
11.004	6.291	30.167
11.004	6.291	30.167
11.012	6.283	30.165
11.019	6.276	30.165
11.019	6.276	30.167
11.026	6.269	30.167
11.026	6.269	30.165
11.026	6.269	30.165
11.033	6.262	30.165
11.033	6.262	30.167
11.033	6.262	30.167
11.04	6.255	30.167
11.047	6.248	30.167
11.047	6.248	30.167
11.047	6.248	30.171
11.055	6.240	30.171
11.062	6.233	30.169
11.062	6.233	30.174
11.062	6.233	30.174
11.069	6.226	30.171
11.069	6.226	30.176
11.083	6.212	30.174
11.09	6.205	30.176
11.09	6.205	30.176

11.09	6.205	30.176
11.09	6.205	30.176
11.098	6.197	30.178
11.098	6.197	30.176
11.105	6.190	30.174
11.112	6.183	30.176
11.119	6.176	30.174
11.119	6.176	30.171
11.126	6.169	30.169
11.134	6.161	30.169
11.134	6.161	30.169
11.141	6.154	30.167
11.148	6.147	30.167
11.148	6.147	30.169
11.155	6.140	30.167
11.162	6.133	30.167
11.169	6.126	30.165
11.169	6.126	30.167
11.184	6.111	30.165
11.184	6.111	30.167
11.191	6.104	30.165
11.191	6.104	30.167
11.205	6.090	30.167
11.205	6.090	30.167
11.212	6.083	30.169
11.212	6.083	30.167
11.212	6.083	30.169
11.227	6.068	30.174
11.227	6.068	30.171
11.234	6.061	30.174
11.241	6.054	30.176
11.248	6.047	30.176
11.248	6.047	30.178
11.255	6.040	30.178
11.263	6.032	30.176
11.263	6.032	30.176
11.27	6.025	30.176
11.284	6.011	30.174
11.291	6.004	30.174
11.298	5.997	30.176
11.298	5.997	30.174
11.306	5.989	30.176
11.32	5.975	30.171
11.313	5.982	30.171
11.32	5.975	30.171
11.327	5.968	30.171
11.334	5.961	30.171
11.341	5.954	30.174
11.349	5.946	30.174
11.349	5.946	30.174
11.356	5.939	30.174
11.363	5.932	30.176
11.37	5.925	30.176
11.37	5.925	30.178
11.377	5.918	30.178
11.385	5.910	30.178

11.392	5.903	30.178
11.392	5.903	30.178
11.392	5.903	30.180
11.399	5.896	30.180
11.413	5.882	30.178
11.413	5.882	30.180
11.406	5.889	30.228
11.413	5.882	30.228
11.42	5.875	30.182
11.42	5.875	30.180
11.428	5.867	30.182
11.435	5.860	30.182
11.435	5.860	30.182
11.442	5.853	30.184
11.442	5.853	30.184
11.449	5.846	30.184
11.449	5.846	30.186
11.449	5.846	30.188
11.449	5.846	30.190
11.456	5.839	30.188
11.463	5.832	30.188
11.463	5.832	30.188
11.478	5.817	30.188
11.471	5.824	30.190
11.471	5.824	30.188
11.471	5.824	30.190
11.478	5.817	30.188
11.478	5.817	30.190
11.485	5.810	30.188
11.492	5.803	30.186
11.492	5.803	30.188
11.492	5.803	30.188
11.492	5.803	30.188
11.492	5.803	30.186
11.499	5.796	30.190
11.499	5.796	30.190
11.499	5.796	30.192
11.499	5.796	30.192
11.506	5.789	30.190
11.506	5.789	30.188
11.514	5.781	30.188
11.514	5.781	30.188
11.514	5.781	30.186
11.514	5.781	30.186
11.514	5.781	30.188
11.521	5.774	30.186
11.521	5.774	30.188
11.521	5.774	30.188
11.521	5.774	30.190
11.521	5.774	30.190
11.514	5.781	30.188
11.521	5.774	30.188
11.521	5.774	30.186
11.521	5.774	30.188
11.521	5.774	30.190
11.521	5.774	30.190

11.521	5.774	30.188
11.521	5.774	30.186
11.521	5.774	30.188
11.521	5.774	30.186
11.514	5.781	30.186
11.514	5.781	30.188
11.506	5.789	30.190
11.514	5.781	30.190
11.514	5.781	30.186
11.506	5.789	30.188
11.514	5.781	30.188
11.514	5.781	30.188
11.514	5.781	30.188
11.514	5.781	30.188
11.514	5.781	30.190
11.506	5.789	30.188
11.514	5.781	30.190
11.514	5.781	30.188
11.506	5.789	30.188
11.506	5.789	30.190
11.499	5.796	30.188
11.506	5.789	30.188
11.499	5.796	30.188
11.492	5.803	30.190
11.492	5.803	30.190
11.485	5.810	30.190
11.492	5.803	30.190
11.485	5.810	30.192
11.485	5.810	30.190
11.478	5.817	30.188
11.471	5.824	30.188
11.471	5.824	30.192
11.471	5.824	30.192
11.463	5.832	30.190
11.463	5.832	30.190
11.449	5.846	30.190
11.449	5.846	30.190
11.442	5.853	30.188
11.435	5.860	30.188
11.435	5.860	30.188
11.435	5.860	30.188
11.428	5.867	30.190
11.428	5.867	30.190
11.42	5.875	30.188
11.42	5.875	30.188
11.413	5.882	30.188
11.413	5.882	30.190
11.406	5.889	30.188
11.399	5.896	30.188
11.399	5.896	30.192
11.392	5.903	30.190
11.392	5.903	30.190
11.385	5.910	30.190
11.385	5.910	30.192
11.385	5.910	30.190
11.37	5.925	30.190

11.37	5.925	30.192
11.37	5.925	30.188
11.356	5.939	30.190
11.356	5.939	30.192
11.349	5.946	30.190
11.349	5.946	30.190
11.341	5.954	30.190
11.341	5.954	30.190
11.334	5.961	30.192
11.327	5.968	30.194
11.32	5.975	30.192
11.313	5.982	30.192
11.32	5.975	30.192
11.313	5.982	30.192
11.298	5.997	30.194
11.306	5.989	30.190
11.298	5.997	30.190
11.298	5.997	30.194
11.277	6.018	30.192
11.27	6.025	30.192
11.263	6.032	30.192
11.263	6.032	30.190
11.255	6.040	30.194
11.255	6.040	30.194
11.248	6.047	30.194
11.234	6.061	30.196
11.227	6.068	30.198
11.227	6.068	30.196
11.22	6.075	30.196
11.212	6.083	30.196
11.198	6.097	30.198
11.198	6.097	30.198
11.191	6.104	30.198
11.191	6.104	30.198
11.177	6.118	30.200
11.177	6.118	30.200
11.169	6.126	30.202
11.162	6.133	30.204
11.155	6.140	30.202
11.148	6.147	30.202
11.148	6.147	30.202
11.134	6.161	30.200
11.134	6.161	30.200
11.126	6.169	30.202
11.119	6.176	30.202
11.112	6.183	30.202
11.098	6.197	30.202
11.09	6.205	30.200
11.083	6.212	30.202
11.076	6.219	30.200
11.076	6.219	30.200
11.069	6.226	30.200
11.062	6.233	30.200
11.055	6.240	30.198
11.047	6.248	30.196
11.047	6.248	30.196

11.04	6.255	30.194
11.033	6.262	30.196
11.026	6.269	30.194
11.019	6.276	30.192
11.012	6.283	30.194
11.004	6.291	30.196
11.004	6.291	30.194
10.997	6.298	30.196
10.997	6.298	30.196
10.99	6.305	30.196
10.976	6.319	30.196
10.983	6.312	30.196
10.969	6.326	30.198
10.969	6.326	30.196
10.961	6.334	30.198
10.954	6.341	30.196
10.947	6.348	30.194
10.947	6.348	30.194
10.94	6.355	30.192
10.933	6.362	30.192
10.918	6.377	30.194
10.911	6.384	30.192
10.911	6.384	30.192
10.904	6.391	30.194
10.897	6.398	30.194
10.897	6.398	30.194
10.89	6.405	30.194
10.882	6.413	30.196
10.875	6.420	30.198
10.875	6.420	30.196
10.868	6.427	30.194
10.861	6.434	30.196
10.861	6.434	30.196
10.854	6.441	30.196
10.854	6.441	30.196
10.847	6.448	30.194
10.847	6.448	30.196
10.839	6.456	30.194
10.839	6.456	30.194
10.832	6.463	30.194
10.832	6.463	30.194
10.832	6.463	30.194
10.825	6.470	30.196
10.825	6.470	30.194
10.818	6.477	30.192
10.818	6.477	30.190
10.811	6.484	30.192
10.811	6.484	30.192
10.811	6.484	30.194
10.811	6.484	30.192
10.811	6.484	30.190
10.804	6.491	30.192
10.796	6.499	30.190
10.804	6.491	30.188
10.796	6.499	30.188
10.796	6.499	30.188

10.789	6.506	30.190
10.789	6.506	30.190
10.789	6.506	30.190
10.789	6.506	30.190
10.789	6.506	30.190
10.782	6.513	30.188
10.782	6.513	30.186
10.789	6.506	30.186
10.789	6.506	30.186
10.782	6.513	30.184
10.789	6.506	30.182
10.782	6.513	30.182
10.789	6.506	30.180
10.789	6.506	30.178
10.782	6.513	30.178
10.782	6.513	30.180
10.789	6.506	30.180
10.782	6.513	30.180
10.789	6.506	30.180
10.789	6.506	30.180
10.789	6.506	30.180
10.789	6.506	30.182
10.789	6.506	30.182
10.789	6.506	30.184
10.789	6.506	30.186
10.796	6.499	30.186
10.796	6.499	30.184
10.789	6.506	30.184
10.789	6.506	30.184
10.796	6.499	30.184
10.796	6.499	30.184
10.804	6.491	30.184
10.804	6.491	30.184
10.804	6.491	30.182
10.804	6.491	30.182
10.804	6.491	30.182
10.811	6.484	30.180
10.811	6.484	30.180
10.811	6.484	30.182
10.811	6.484	30.184
10.818	6.477	30.186
10.818	6.477	30.186
10.825	6.470	30.188
10.832	6.463	30.188
10.825	6.470	30.188
10.832	6.463	30.188
10.832	6.463	30.190
10.839	6.456	30.188
10.839	6.456	30.190
10.847	6.448	30.190
10.854	6.441	30.188
10.854	6.441	30.190
10.861	6.434	30.188
10.861	6.434	30.188
10.868	6.427	30.188
10.868	6.427	30.188

10.875	6.420	30.188
10.875	6.420	30.188
10.875	6.420	30.186
10.882	6.413	30.186
10.89	6.405	30.186
10.89	6.405	30.184
10.89	6.405	30.182
10.897	6.398	30.182
10.897	6.398	30.184
10.904	6.391	30.182
10.904	6.391	30.182
10.911	6.384	30.186
10.911	6.384	30.186
10.918	6.377	30.186
10.926	6.369	30.188
10.933	6.362	30.184
10.94	6.355	30.184
10.94	6.355	30.184
10.94	6.355	30.186
10.954	6.341	30.186
10.961	6.334	30.186
10.969	6.326	30.186
10.969	6.326	30.186
10.976	6.319	30.186
10.976	6.319	30.186
10.976	6.319	30.188
10.99	6.305	30.190
10.99	6.305	30.190
11.004	6.291	30.192
11.004	6.291	30.192
11.012	6.283	30.194
11.012	6.283	30.194
11.019	6.276	30.196
11.019	6.276	30.196
11.026	6.269	30.198
11.033	6.262	30.198
11.04	6.255	30.204
11.047	6.248	30.202
11.055	6.240	30.200
11.062	6.233	30.202
11.062	6.233	30.202
11.069	6.226	30.204
11.076	6.219	30.204
11.083	6.212	30.202
11.083	6.212	30.204
11.09	6.205	30.204
11.105	6.190	30.204
11.105	6.190	30.204
11.119	6.176	30.206
11.126	6.169	30.206
11.134	6.161	30.206
11.134	6.161	30.204
11.141	6.154	30.204
11.148	6.147	30.204
11.162	6.133	30.204
11.169	6.126	30.204

11.177	6.118	30.204
11.177	6.118	30.200
11.191	6.104	30.200
11.191	6.104	30.202
11.198	6.097	30.202
11.205	6.090	30.202
11.22	6.075	30.204
11.22	6.075	30.204
11.227	6.068	30.204
11.227	6.068	30.206
11.241	6.054	30.206
11.241	6.054	30.208
11.255	6.040	30.208
11.263	6.032	30.210
11.263	6.032	30.208
11.27	6.025	30.210
11.27	6.025	30.208
11.284	6.011	30.208
11.284	6.011	30.208
11.291	6.004	30.210
11.298	5.997	30.212
11.313	5.982	30.212
11.313	5.982	30.212
11.327	5.968	30.212
11.327	5.968	30.212
11.341	5.954	30.210
11.341	5.954	30.210
11.349	5.946	30.208
11.356	5.939	30.206
11.363	5.932	30.204
11.37	5.925	30.204
11.385	5.910	30.204
11.392	5.903	30.204
11.392	5.903	30.206
11.399	5.896	30.206
11.406	5.889	30.204
11.413	5.882	30.202
11.413	5.882	30.204
11.42	5.875	30.204
11.42	5.875	30.206
11.428	5.867	30.206
11.435	5.860	30.204
11.442	5.853	30.204
11.449	5.846	30.202
11.449	5.846	30.204
11.456	5.839	30.206
11.463	5.832	30.208
11.463	5.832	30.212
11.463	5.832	30.210
11.471	5.824	30.210
11.478	5.817	30.210
11.485	5.810	30.212
11.485	5.810	30.214
11.485	5.810	30.267
11.485	5.810	30.269
11.492	5.803	30.216

11.499	5.796	30.216
11.499	5.796	30.218
11.506	5.789	30.218
11.506	5.789	30.218
11.506	5.789	30.222
11.514	5.781	30.224
11.514	5.781	30.222
11.514	5.781	30.224
11.514	5.781	30.226
11.521	5.774	30.231
11.528	5.767	30.235
11.535	5.760	30.239
11.535	5.760	30.237
11.535	5.760	30.233
11.542	5.753	30.233
11.535	5.760	30.233
11.542	5.753	30.233
11.542	5.753	30.231
11.549	5.746	30.233
11.549	5.746	30.235
11.549	5.746	30.233
11.549	5.746	30.235
11.549	5.746	30.235
11.571	5.724	30.235
11.571	5.724	30.237
11.557	5.738	30.237
11.571	5.724	30.239
11.571	5.724	30.239
11.571	5.724	30.243
11.564	5.731	30.245
11.564	5.731	30.245
11.564	5.731	30.247
11.571	5.724	30.245
11.571	5.724	30.247
11.578	5.717	30.247
11.571	5.724	30.247
11.578	5.717	30.247
11.571	5.724	30.247
11.571	5.724	30.247
11.578	5.717	30.249
11.571	5.724	30.253
11.564	5.731	30.255
11.564	5.731	30.251
11.564	5.731	30.253
11.564	5.731	30.251
11.564	5.731	30.253
11.564	5.731	30.253
11.564	5.731	30.253
11.571	5.724	30.251
11.564	5.731	30.253
11.557	5.738	30.251
11.564	5.731	30.253
11.557	5.738	30.251
11.557	5.738	30.251
11.557	5.738	30.255
11.557	5.738	30.255
11.557	5.738	30.257

11.549	5.746	30.253
11.549	5.746	30.255
11.542	5.753	30.255
11.542	5.753	30.257
11.542	5.753	30.257
11.535	5.760	30.255
11.535	5.760	30.255
11.528	5.767	30.255
11.528	5.767	30.253
11.528	5.767	30.255
11.521	5.774	30.253
11.514	5.781	30.255
11.514	5.781	30.253
11.506	5.789	30.255
11.506	5.789	30.253
11.506	5.789	30.255
11.506	5.789	30.255
11.499	5.796	30.255
11.492	5.803	30.255
11.492	5.803	30.255
11.492	5.803	30.255
11.485	5.810	30.257
11.478	5.817	30.259
11.478	5.817	30.259
11.463	5.832	30.257
11.471	5.824	30.257
11.463	5.832	30.257
11.449	5.846	30.259
11.449	5.846	30.261
11.442	5.853	30.263
11.42	5.875	30.265
11.42	5.875	30.265
11.428	5.867	30.263
11.428	5.867	30.265
11.406	5.889	30.265
11.406	5.889	30.261
11.399	5.896	30.265
11.399	5.896	30.263
11.392	5.903	30.265
11.385	5.910	30.265
11.377	5.918	30.263
11.385	5.910	30.265
11.37	5.925	30.267
11.363	5.932	30.265
11.349	5.946	30.265
11.341	5.954	30.267
11.341	5.954	30.267
11.334	5.961	30.267
11.327	5.968	30.269
11.32	5.975	30.269
11.313	5.982	30.271
11.306	5.989	30.269
11.298	5.997	30.269
11.291	6.004	30.269
11.284	6.011	30.269
11.284	6.011	30.269

11.27	6.025	30.271
11.27	6.025	30.271
11.263	6.032	30.275
11.255	6.040	30.320
11.234	6.061	30.318
11.241	6.054	30.269
11.234	6.061	30.269
11.227	6.068	30.271
11.22	6.075	30.271
11.205	6.090	30.271
11.198	6.097	30.273
11.191	6.104	30.275
11.184	6.111	30.273
11.184	6.111	30.273
11.169	6.126	30.273
11.169	6.126	30.273
11.162	6.133	30.273
11.155	6.140	30.273
11.141	6.154	30.275
11.126	6.169	30.316

In-Situ Inc.

Hermit 3000

Report generated:

11/1/04

7:34:48

Report from file:

C:\Win-Situ\Data\SN45674 2004-10-25 162645 DARECO BACKGRD .bin

DataMgr Version

3.68

Serial number:

45674

Firmware Version

7.10

Unit name:

HERMIT 3000

Test name:

DARE ORVILLE RECOVERY

Test defined on:

10/21/04

13:10:58

Test started on:

10/25/04

10:04:08

Test stopped on:

10/25/04

15:07:30

Test extracted on:

11/1/04

8:26:43

Data gathered using Logarithmic testing

Maximum time between data points:

Number of data samples:

238

TOTAL DATA SAMPLES

238

Channel number [1]

Measurement type:

Pressure

Channel name:

Probe #1

Linearity:

0.2503

Scale:

Offset:

Warmup:

Specific gravity:

1

Mode:

TOC

User-defined reference:

18.9

Referenced on:

channel definition.

Pressure head at reference:

72.602

Channel number [3]

Measurement type:

Pressure

Channel name:

Probe #3

Linearity:

0.0175000

Scale:

49.7382000

Offset:

-0.2552000

Warmup:

50

Specific gravity:

1.000

Mode:

TOC

User-defined reference:

18.25

Referenced on:

channel definition.

Pressure head at reference:

31.748

Channel number [0]

Measurement type:

Barometric Pressure

Channel name:

Barometric

Linearity:

0.0000000

Scale:

0.0000000

Offset:

0.0000000

Warmup:

50

Date	Time	ET (min)	Chan[1] Feet H2O	Chan[1] Feet H2O	PW Orville Recovery (ft)	Chan[3] Feet H2O
10/28/04	12:04:41	0.0000	-41.908	38.092	19.675	-11.119
10/28/04	12:04:41	0.0163	-41.821	38.179	19.762	-11.119

10/28/04	12:04:42	0.0327	-42.210	37.790	19.373	-11.119
10/28/04	12:04:43	0.0490	-42.153	37.847	19.430	-11.119
10/28/04	12:04:44	0.0653	-41.893	38.107	19.690	-11.119
10/28/04	12:04:45	0.0817	-41.490	38.510	20.093	-11.119
10/28/04	12:04:46	0.0980	-41.965	38.035	19.618	-11.112
10/28/04	12:04:47	0.1143	-41.879	38.121	19.704	-11.119
10/28/04	12:04:48	0.1307	-42.210	37.790	19.373	-11.119
10/28/04	12:04:49	0.1470	-41.735	38.265	19.848	-11.119
10/28/04	12:04:50	0.1633	-41.980	38.020	19.603	-11.112
10/28/04	12:04:51	0.1797	-42.239	37.761	19.344	-11.119
10/28/04	12:04:52	0.1960	-42.455	37.545	19.128	-11.119
10/28/04	12:04:53	0.2123	-41.864	38.136	19.719	-11.119
10/28/04	12:04:54	0.2287	-41.807	38.193	19.776	-11.119
10/28/04	12:04:55	0.2450	-42.153	37.847	19.430	-11.119
10/28/04	12:04:56	0.2613	-42.282	37.718	19.301	-11.119
10/28/04	12:04:57	0.2777	-42.008	37.992	19.575	-11.119
10/28/04	12:04:58	0.2940	-41.893	38.107	19.690	-11.119
10/28/04	12:04:59	0.3103	-41.663	38.337	19.920	-11.119
10/28/04	12:05:00	0.3267	-42.138	37.862	19.445	-11.119
10/28/04	12:05:01	0.3433	-41.951	38.049	19.632	-11.119
10/28/04	12:05:02	0.3610	-42.037	37.963	19.546	-11.119
10/28/04	12:05:03	0.3797	-41.317	38.683	20.266	-11.119
10/28/04	12:05:04	0.3995	-41.619	38.381	19.964	-11.119
10/28/04	12:05:06	0.4205	-42.225	37.775	19.358	-11.119
10/28/04	12:05:07	0.4427	-41.879	38.121	19.704	-11.119
10/28/04	12:05:08	0.4662	-45.121	34.879	16.462	-11.119
10/28/04	12:05:10	0.4910	-46.231	33.769	15.352	-11.126
10/28/04	12:05:12	0.5173	-49.301	30.699	12.282	-11.134
10/28/04	12:05:13	0.5453	-52.472	27.528	9.111	-11.169
10/28/04	12:05:15	0.5750	-54.735	25.265	6.848	-11.227
10/28/04	12:05:17	0.6063	-55.672	24.328	5.911	-11.284
10/28/04	12:05:19	0.6395	-56.926	23.074	4.657	-11.499
10/28/04	12:05:21	0.6747	-56.882	23.118	4.701	-11.707
10/28/04	12:05:23	0.7120	-56.839	23.161	4.744	-11.958
10/28/04	12:05:26	0.7515	-56.940	23.060	4.643	-12.202
10/28/04	12:05:28	0.7933	-57.200	22.800	4.383	-12.439
10/28/04	12:05:31	0.8377	-57.358	22.642	4.225	-12.647
10/28/04	12:05:34	0.8847	-57.445	22.555	4.138	-12.833
10/28/04	12:05:37	0.9345	-57.574	22.426	4.009	-12.969
10/28/04	12:05:40	0.9872	-57.733	22.267	3.850	-13.113
10/28/04	12:05:43	1.0430	-57.834	22.166	3.749	-13.228
10/28/04	12:05:47	1.1022	-57.920	22.080	3.663	-13.335
10/28/04	12:05:50	1.1648	-58.050	21.950	3.533	-13.436
10/28/04	12:05:54	1.2312	-58.122	21.878	3.461	-13.536
10/28/04	12:05:59	1.3015	-58.252	21.748	3.331	-13.629
10/28/04	12:06:03	1.3760	-58.310	21.690	3.273	-13.715
10/28/04	12:06:08	1.4550	-58.382	21.618	3.201	-13.801
10/28/04	12:06:13	1.5387	-58.454	21.546	3.129	-13.866
10/28/04	12:06:18	1.6272	-58.526	21.474	3.057	-13.945
10/28/04	12:06:24	1.7210	-58.583	21.417	3.000	-14.002
10/28/04	12:06:30	1.8203	-58.656	21.344	2.927	-14.074
10/28/04	12:06:36	1.9257	-58.713	21.287	2.870	-14.131
10/28/04	12:06:43	2.0372	-58.771	21.229	2.812	-14.189
10/28/04	12:06:50	2.1553	-58.814	21.186	2.769	-14.246
10/28/04	12:06:57	2.2805	-58.872	21.128	2.711	-14.289
10/28/04	12:07:05	2.4130	-58.901	21.099	2.682	-14.346
10/28/04	12:07:14	2.5535	-58.944	21.056	2.639	-14.389
10/28/04	12:07:23	2.7023	-58.987	21.013	2.596	-14.433

10/28/04	12:07:32	2.8598	-59.045	20.955	2.538	-14.468
10/28/04	12:07:42	3.0267	-59.088	20.912	2.495	-14.511
10/28/04	12:07:53	3.2035	-59.117	20.883	2.466	-14.547
10/28/04	12:08:04	3.3908	-59.160	20.840	2.423	-14.590
10/28/04	12:08:16	3.5892	-59.189	20.811	2.394	-14.619
10/28/04	12:08:28	3.7993	-59.203	20.797	2.380	-14.655
10/28/04	12:08:42	4.0220	-59.247	20.753	2.336	-14.698
10/28/04	12:08:56	4.2578	-59.275	20.725	2.308	-14.719
10/28/04	12:09:11	4.5077	-59.304	20.696	2.279	-14.755
10/28/04	12:09:27	4.7723	-59.319	20.681	2.264	-14.777
10/28/04	12:09:44	5.0527	-59.362	20.638	2.221	-14.805
10/28/04	12:10:01	5.3495	-59.391	20.609	2.192	-14.834
10/28/04	12:10:20	5.6640	-59.405	20.595	2.178	-14.849
10/28/04	12:10:40	5.9972	-59.275	20.725	2.308	-14.892
10/28/04	12:11:02	6.3500	-59.304	20.696	2.279	-14.913
10/28/04	12:11:24	6.7238	-59.319	20.681	2.264	-14.935
10/28/04	12:11:48	7.1198	-59.362	20.638	2.221	-14.963
10/28/04	12:12:13	7.5392	-59.362	20.638	2.221	-14.985
10/28/04	12:12:40	7.9835	-59.391	20.609	2.192	-15.006
10/28/04	12:13:08	8.4542	-59.420	20.580	2.163	-15.021
10/28/04	12:13:38	8.9527	-59.434	20.566	2.149	-15.056
10/28/04	12:14:09	9.4807	-59.463	20.537	2.120	-15.071
10/28/04	12:14:43	10.0400	-59.492	20.508	2.091	-15.085
10/28/04	12:15:18	10.6325	-59.506	20.494	2.077	-15.114
10/28/04	12:15:56	11.2600	-59.520	20.480	2.063	-15.135
10/28/04	12:16:36	11.9248	-59.535	20.465	2.048	-15.150
10/28/04	12:17:18	12.6290	-59.549	20.451	2.034	-15.171
10/28/04	12:18:03	13.3748	-59.564	20.436	2.019	-15.193
10/28/04	12:18:50	14.1648	-59.593	20.407	1.990	-15.207
10/28/04	12:19:41	15.0017	-59.607	20.393	1.976	-15.229
10/28/04	12:20:34	15.8882	-59.636	20.364	1.947	-15.236
10/28/04	12:21:30	16.8272	-59.650	20.350	1.933	-15.257
10/28/04	12:22:30	17.8218	-59.679	20.321	1.904	-15.279
10/28/04	12:23:33	18.8755	-59.679	20.321	1.904	-15.293
10/28/04	12:24:40	19.9915	-59.708	20.292	1.875	-15.322
10/28/04	12:25:51	21.1737	-59.737	20.263	1.846	-15.336
10/28/04	12:27:06	22.4258	-59.737	20.263	1.846	-15.351
10/28/04	12:28:26	23.7523	-59.766	20.234	1.817	-15.372
10/28/04	12:29:50	25.1573	-59.780	20.220	1.803	-15.386
10/28/04	12:31:19	26.6457	-59.780	20.220	1.803	-15.401
10/28/04	12:32:54	28.2222	-59.809	20.191	1.774	-15.415
10/28/04	12:34:34	29.8920	-59.823	20.177	1.760	-15.429
10/28/04	12:36:20	31.6608	-59.838	20.162	1.745	-15.437
10/28/04	12:38:13	33.5345	-60.011	19.989	1.572	-15.451
10/28/04	12:40:12	35.5192	-60.025	19.975	1.558	-15.458
10/28/04	12:42:12	37.5192	-59.895	20.105	1.688	-15.472
10/28/04	12:44:12	39.5192	-59.910	20.090	1.673	-15.487
10/28/04	12:46:12	41.5192	-59.910	20.090	1.673	-15.508
10/28/04	12:48:12	43.5192	-59.924	20.076	1.659	-15.515
10/28/04	12:50:12	45.5192	-59.939	20.061	1.644	-15.515
10/28/04	12:52:12	47.5192	-59.939	20.061	1.644	-15.530
10/28/04	12:54:12	49.5192	-59.953	20.047	1.630	-15.530
10/28/04	12:56:12	51.5192	-59.953	20.047	1.630	-15.544
10/28/04	12:58:12	53.5192	-59.982	20.018	1.601	-15.544
10/28/04	13:00:12	55.5192	-59.982	20.018	1.601	-15.551
10/28/04	13:02:12	57.5192	-59.982	20.018	1.601	-15.559
10/28/04	13:04:12	59.5192	-59.982	20.018	1.601	-15.566
10/28/04	13:06:12	61.5192	-59.982	20.018	1.601	-15.566

10/28/04	13:08:12	63.5192	-59.982	20.018	1.601	-15.573
10/28/04	13:10:12	65.5192	-60.011	19.989	1.572	-15.573
10/28/04	13:12:12	67.5192	-59.996	20.004	1.587	-15.580
10/28/04	13:14:12	69.5192	-60.025	19.975	1.558	-15.587
10/28/04	13:16:12	71.5192	-60.011	19.989	1.572	-15.587
10/28/04	13:18:12	73.5192	-60.011	19.989	1.572	-15.587
10/28/04	13:20:12	75.5192	-60.011	19.989	1.572	-15.580
10/28/04	13:22:12	77.5192	-60.025	19.975	1.558	-15.587
10/28/04	13:24:12	79.5192	-60.025	19.975	1.558	-15.594
10/28/04	13:26:12	81.5192	-60.025	19.975	1.558	-15.587
10/28/04	13:28:12	83.5192	-60.025	19.975	1.558	-15.594
10/28/04	13:30:12	85.5192	-60.025	19.975	1.558	-15.594
10/28/04	13:32:12	87.5192	-60.039	19.961	1.544	-15.602
10/28/04	13:34:12	89.5192	-60.025	19.975	1.558	-15.594
10/28/04	13:36:12	91.5192	-60.039	19.961	1.544	-15.602
10/28/04	13:38:12	93.5192	-60.039	19.961	1.544	-15.594
10/28/04	13:40:12	95.5192	-60.025	19.975	1.558	-15.602
10/28/04	13:42:12	97.5192	-60.039	19.961	1.544	-15.609
10/28/04	13:44:12	99.5192	-60.039	19.961	1.544	-15.609
10/28/04	13:46:12	101.5192	-60.039	19.961	1.544	-15.609
10/28/04	13:48:12	103.5192	-60.039	19.961	1.544	-15.609
10/28/04	13:50:12	105.5192	-60.039	19.961	1.544	-15.609
10/28/04	13:52:12	107.5192	-60.039	19.961	1.544	-15.609
10/28/04	13:54:12	109.5192	-60.039	19.961	1.544	-15.609
10/28/04	13:56:12	111.5192	-60.039	19.961	1.544	-15.616
10/28/04	13:58:12	113.5192	-60.039	19.961	1.544	-15.609
10/28/04	14:00:12	115.5192	-60.054	19.946	1.529	-15.609
10/28/04	14:02:12	117.5192	-60.054	19.946	1.529	-15.616
10/28/04	14:04:12	119.5192	-60.054	19.946	1.529	-15.609
10/28/04	14:06:12	121.5192	-60.039	19.961	1.544	-15.616
10/28/04	14:08:12	123.5192	-60.054	19.946	1.529	-15.616
10/28/04	14:10:12	125.5192	-60.054	19.946	1.529	-15.609
10/28/04	14:12:12	127.5192	-60.039	19.961	1.544	-15.609
10/28/04	14:14:12	129.5192	-60.054	19.946	1.529	-15.616
10/28/04	14:16:12	131.5192	-60.054	19.946	1.529	-15.616
10/28/04	14:18:12	133.5192	-60.054	19.946	1.529	-15.616
10/28/04	14:20:12	135.5192	-60.068	19.932	1.515	-15.616
10/28/04	14:22:12	137.5192	-60.054	19.946	1.529	-15.623
10/28/04	14:24:12	139.5192	-60.068	19.932	1.515	-15.623
10/28/04	14:26:12	141.5192	-60.068	19.932	1.515	-15.623
10/28/04	14:28:12	143.5192	-60.068	19.932	1.515	-15.623
10/28/04	14:30:12	145.5192	-60.068	19.932	1.515	-15.623
10/28/04	14:32:12	147.5192	-60.068	19.932	1.515	-15.630
10/28/04	14:34:12	149.5192	-60.068	19.932	1.515	-15.630
10/28/04	14:36:12	151.5192	-60.083	19.917	1.500	-15.623
10/28/04	14:38:12	153.5192	-60.083	19.917	1.500	-15.637
10/28/04	14:40:12	155.5192	-60.083	19.917	1.500	-15.630
10/28/04	14:42:12	157.5192	-60.083	19.917	1.500	-15.637
10/28/04	14:44:12	159.5192	-60.097	19.903	1.486	-15.645
10/28/04	14:46:12	161.5192	-60.068	19.932	1.515	-15.645
10/28/04	14:48:12	163.5192	-60.097	19.903	1.486	-15.645
10/28/04	14:50:12	165.5192	-60.083	19.917	1.500	-15.645
10/28/04	14:52:12	167.5192	-60.083	19.917	1.500	-15.645
10/28/04	14:54:12	169.5192	-60.083	19.917	1.500	-15.652
10/28/04	14:56:12	171.5192	-60.083	19.917	1.500	-15.652
10/28/04	14:58:12	173.5192	-60.097	19.903	1.486	-15.659
10/28/04	15:00:12	175.5192	-60.097	19.903	1.486	-15.652
10/28/04	15:02:12	177.5192	-60.097	19.903	1.486	-15.659

10/28/04	15:04:12	179.5192	-60.097	19.903	1.486	-15.673
10/28/04	15:06:12	181.5192	-60.097	19.903	1.486	-15.659
10/28/04	15:08:12	183.5192	-60.126	19.874	1.457	-15.680
10/28/04	15:10:12	185.5192	-60.126	19.874	1.457	-15.680
10/28/04	15:12:12	187.5192	-60.126	19.874	1.457	-15.680
10/28/04	15:14:12	189.5192	-60.126	19.874	1.457	-15.680
10/28/04	15:16:12	191.5192	-60.140	19.860	1.443	-15.688
10/28/04	15:18:12	193.5192	-60.140	19.860	1.443	-15.688
10/28/04	15:20:12	195.5192	-60.126	19.874	1.457	-15.688
10/28/04	15:22:12	197.5192	-60.140	19.860	1.443	-15.695
10/28/04	15:24:12	199.5192	-60.155	19.845	1.428	-15.688
10/28/04	15:26:12	201.5192	-60.155	19.845	1.428	-15.702
10/28/04	15:28:12	203.5192	-60.155	19.845	1.428	-15.702
10/28/04	15:30:12	205.5192	-60.155	19.845	1.428	-15.702
10/28/04	15:32:12	207.5192	-60.155	19.845	1.428	-15.702
10/28/04	15:34:12	209.5192	-60.155	19.845	1.428	-15.709
10/28/04	15:36:12	211.5192	-60.169	19.831	1.414	-15.709
10/28/04	15:38:12	213.5192	-60.155	19.845	1.428	-15.709
10/28/04	15:40:12	215.5192	-60.169	19.831	1.414	-15.716
10/28/04	15:42:12	217.5192	-60.169	19.831	1.414	-15.716
10/28/04	15:44:12	219.5192	-60.169	19.831	1.414	-15.731
10/28/04	15:46:12	221.5192	-60.184	19.816	1.399	-15.723
10/28/04	15:48:12	223.5192	-60.184	19.816	1.399	-15.731
10/28/04	15:50:12	225.5192	-60.184	19.816	1.399	-15.738
10/28/04	15:52:12	227.5192	-60.184	19.816	1.399	-15.738
10/28/04	15:54:12	229.5192	-60.198	19.802	1.385	-15.745
10/28/04	15:56:12	231.5192	-60.198	19.802	1.385	-15.752
10/28/04	15:58:12	233.5192	-60.198	19.802	1.385	-15.752
10/28/04	16:00:12	235.5192	-60.198	19.802	1.385	-15.759
10/28/04	16:02:12	237.5192	-60.212	19.788	1.371	-15.767
10/28/04	16:04:12	239.5192	-60.212	19.788	1.371	-15.767
10/28/04	16:06:12	241.5192	-60.212	19.788	1.371	-15.774
10/28/04	16:08:12	243.5192	-60.212	19.788	1.371	-15.774
10/28/04	16:10:12	245.5192	-60.227	19.773	1.356	-15.781
10/28/04	16:12:12	247.5192	-60.227	19.773	1.356	-15.788
10/28/04	16:14:12	249.5192	-60.241	19.759	1.342	-15.788
10/28/04	16:16:12	251.5192	-60.241	19.759	1.342	-15.795
10/28/04	16:18:12	253.5192	-60.241	19.759	1.342	-15.795
10/28/04	16:20:12	255.5192	-60.241	19.759	1.342	-15.810
10/28/04	16:22:12	257.5192	-60.241	19.759	1.342	-15.810
10/28/04	16:24:12	259.5192	-60.256	19.744	1.327	-15.817
10/28/04	16:26:12	261.5192	-60.270	19.730	1.313	-15.817
10/28/04	16:28:12	263.5192	-60.270	19.730	1.313	-15.824
10/28/04	16:30:12	265.5192	-60.270	19.730	1.313	-15.831
10/28/04	16:32:12	267.5192	-60.270	19.730	1.313	-15.831
10/28/04	16:34:12	269.5192	-60.285	19.715	1.298	-15.838
10/28/04	16:36:12	271.5192	-60.285	19.715	1.298	-15.845
10/28/04	16:38:12	273.5192	-60.285	19.715	1.298	-15.845
10/28/04	16:40:12	275.5192	-60.285	19.715	1.298	-15.853
10/28/04	16:42:12	277.5192	-60.299	19.701	1.284	-15.860
10/28/04	16:44:12	279.5192	-60.299	19.701	1.284	-15.867
10/28/04	16:46:12	281.5192	-60.313	19.687	1.270	-15.867
10/28/04	16:48:12	283.5192	-60.313	19.687	1.270	-15.867
10/28/04	16:50:12	285.5192	-60.328	19.672	1.255	-15.881
10/28/04	16:52:12	287.5192	-60.328	19.672	1.255	-15.881
10/28/04	16:54:12	289.5192	-60.328	19.672	1.255	-15.896
10/28/04	16:56:12	291.5192	-60.328	19.672	1.255	-15.903
10/28/04	16:58:12	293.5192	-60.357	19.643	1.226	-15.903

10/28/04	17:00:12	295.5192	-60.357	19.643	1.226	-15.917
10/28/04	17:02:12	297.5192	-60.357	19.643	1.226	-15.917
10/28/04	17:04:12	299.5192	-60.357	19.643	1.226	-15.924
10/28/04	17:06:12	301.5192	-60.371	19.629	1.212	-15.939
10/28/04	17:08:12	303.5192	-60.385	19.615	1.198	-15.946
10/28/04	17:10:12	305.5192	-60.385	19.615	1.198	-15.946
10/28/04	17:12:12	307.5192	-60.385	19.615	1.198	-15.953
10/28/04	17:14:12	309.5192	-60.400	19.600	1.183	-15.953
10/28/04	17:16:12	311.5192	-60.400	19.600	1.183	-15.960
10/28/04	17:18:12	313.5192	-60.414	19.586	1.169	-15.967
10/28/04	17:20:12	315.5192	-60.414	19.586	1.169	-15.967
10/28/04	17:22:12	317.5192	-60.429	19.571	1.154	-15.982
10/28/04	17:24:12	319.5192	-60.429	19.571	1.154	-15.989
10/28/04	17:26:12	321.5192	-60.429	19.571	1.154	-15.996
10/28/04	17:28:12	323.5192	-60.443	19.557	1.140	-16.003
10/28/04	17:30:12	325.5192	-60.443	19.557	1.140	-16.010
10/28/04	17:32:12	327.5192	-60.458	19.542	1.125	-16.010
10/28/04	17:34:12	329.5192	-60.458	19.542	1.125	-16.018
10/28/04	17:36:12	331.5192	-60.472	19.528	1.111	-16.032
10/28/04	17:38:12	333.5192	-60.472	19.528	1.111	-16.039
10/28/04	17:40:12	335.5192	-60.486	19.514	1.097	-16.039
10/28/04	17:42:12	337.5192	-60.486	19.514	1.097	-16.039
10/28/04	17:44:12	339.5192	-60.501	19.499	1.082	-16.053
10/28/04	17:46:12	341.5192	-60.501	19.499	1.082	-16.061
10/28/04	17:48:12	343.5192	-60.501	19.499	1.082	-16.068
10/28/04	17:50:12	345.5192	-60.515	19.485	1.068	-16.068
10/28/04	17:52:12	347.5192	-60.515	19.485	1.068	-16.082
10/28/04	17:54:12	349.5192	-60.530	19.470	1.053	-16.082
10/28/04	17:56:12	351.5192	-60.530	19.470	1.053	-16.089
10/28/04	17:58:12	353.5192	-60.544	19.456	1.039	-16.104
10/28/04	18:00:12	355.5192	-60.544	19.456	1.039	-16.111
10/28/04	18:02:12	357.5192	-60.558	19.442	1.025	-16.118
10/28/04	18:04:12	359.5192	-60.717	19.283	0.866	-16.111
10/28/04	18:06:12	361.5192	-60.573	19.427	1.010	-16.139
10/28/04	18:08:12	363.5192	-60.573	19.427	1.010	-16.147
10/28/04	18:10:12	365.5192	-60.587	19.413	0.996	-16.154
10/28/04	18:12:12	367.5192	-60.602	19.398	0.981	-16.161
10/28/04	18:14:12	369.5192	-60.602	19.398	0.981	-16.168
10/28/04	18:16:12	371.5192	-60.602	19.398	0.981	-16.182
10/28/04	18:18:12	373.5192	-60.616	19.384	0.967	-16.182
10/28/04	18:20:12	375.5192	-60.616	19.384	0.967	-16.190
10/28/04	18:22:12	377.5192	-60.631	19.369	0.952	-16.190
10/28/04	18:24:12	379.5192	-60.631	19.369	0.952	-16.204
10/28/04	18:26:12	381.5192	-60.645	19.355	0.938	-16.211
10/28/04	18:28:12	383.5192	-60.659	19.341	0.924	-16.226
10/28/04	18:30:12	385.5192	-60.659	19.341	0.924	-16.226
10/28/04	18:32:12	387.5192	-60.674	19.326	0.909	-16.233
10/28/04	18:34:12	389.5192	-60.674	19.326	0.909	-16.240
10/28/04	18:36:12	391.5192	-60.674	19.326	0.909	-16.247
10/28/04	18:38:12	393.5192	-60.688	19.312	0.895	-16.261
10/28/04	18:40:12	395.5192	-60.703	19.297	0.880	-16.261
10/28/04	18:42:12	397.5192	-60.703	19.297	0.880	-16.276
10/28/04	18:44:12	399.5192	-60.717	19.283	0.866	-16.276
10/28/04	18:46:12	401.5192	-60.717	19.283	0.866	-16.290
10/28/04	18:48:12	403.5192	-60.717	19.283	0.866	-16.290
10/28/04	18:50:12	405.5192	-60.731	19.269	0.852	-16.297
10/28/04	18:52:12	407.5192	-60.731	19.269	0.852	-16.304
10/28/04	18:54:12	409.5192	-60.746	19.254	0.837	-16.312

10/28/04	18:56:12	411.5192	-60.746	19.254	0.837	-16.319
10/28/04	18:58:12	413.5192	-60.760	19.240	0.823	-16.326
10/28/04	19:00:12	415.5192	-60.760	19.240	0.823	-16.333
10/28/04	19:02:12	417.5192	-60.775	19.225	0.808	-16.340
10/28/04	19:04:12	419.5192	-60.804	19.196	0.779	-16.355
10/28/04	19:06:12	421.5192	-60.789	19.211	0.794	-16.355
10/28/04	19:08:12	423.5192	-60.789	19.211	0.794	-16.362
10/28/04	19:10:12	425.5192	-60.818	19.182	0.765	-16.376
10/28/04	19:12:12	427.5192	-60.804	19.196	0.779	-16.376
10/28/04	19:14:12	429.5192	-60.832	19.168	0.751	-16.383
10/28/04	19:16:12	431.5192	-60.847	19.153	0.736	-16.390
10/28/04	19:18:12	433.5192	-60.847	19.153	0.736	-16.390
10/28/04	19:20:12	435.5192	-60.847	19.153	0.736	-16.398
10/28/04	19:22:12	437.5192	-60.861	19.139	0.722	-16.405
10/28/04	19:24:12	439.5192	-60.861	19.139	0.722	-16.412
10/28/04	19:26:12	441.5192	-60.861	19.139	0.722	-16.412
10/28/04	19:28:12	443.5192	-60.876	19.124	0.707	-16.426
10/28/04	19:30:12	445.5192	-60.876	19.124	0.707	-16.433
10/28/04	19:32:12	447.5192	-60.890	19.110	0.693	-16.441
10/28/04	19:34:12	449.5192	-60.904	19.096	0.679	-16.448
10/28/04	19:36:12	451.5192	-60.904	19.096	0.679	-16.455
10/28/04	19:38:12	453.5192	-60.904	19.096	0.679	-16.462
10/28/04	19:40:12	455.5192	-60.919	19.081	0.664	-16.462
10/28/04	19:42:12	457.5192	-60.919	19.081	0.664	-16.469
10/28/04	19:44:12	459.5192	-60.933	19.067	0.650	-16.477
10/28/04	19:46:12	461.5192	-60.933	19.067	0.650	-16.498
10/28/04	19:48:12	463.5192	-60.948	19.052	0.635	-16.498
10/28/04	19:50:12	465.5192	-60.948	19.052	0.635	-16.505
10/28/04	19:52:12	467.5192	-60.948	19.052	0.635	-16.512
10/28/04	19:54:12	469.5192	-60.962	19.038	0.621	-16.520
10/28/04	19:56:12	471.5192	-60.962	19.038	0.621	-16.527
10/28/04	19:58:12	473.5192	-60.977	19.023	0.606	-16.534
10/28/04	20:00:12	475.5192	-60.977	19.023	0.606	-16.534
10/28/04	20:02:12	477.5192	-60.977	19.023	0.606	-16.534
10/28/04	20:04:12	479.5192	-60.991	19.009	0.592	-16.541
10/28/04	20:06:12	481.5192	-60.991	19.009	0.592	-16.555
10/28/04	20:08:12	483.5192	-61.005	18.995	0.578	-16.555
10/28/04	20:10:12	485.5192	-61.005	18.995	0.578	-16.563
10/28/04	20:12:12	487.5192	-61.020	18.980	0.563	-16.570
10/28/04	20:14:12	489.5192	-61.005	18.995	0.578	-16.570
10/28/04	20:16:12	491.5192	-61.020	18.980	0.563	-16.577
10/28/04	20:18:12	493.5192	-61.020	18.980	0.563	-16.577
10/28/04	20:20:12	495.5192	-61.034	18.966	0.549	-16.584
10/28/04	20:22:12	497.5192	-61.034	18.966	0.549	-16.591
10/28/04	20:24:12	499.5192	-61.034	18.966	0.549	-16.591
10/28/04	20:26:12	501.5192	-61.034	18.966	0.549	-16.598
10/28/04	20:28:12	503.5192	-61.049	18.951	0.534	-16.598
10/28/04	20:30:12	505.5192	-61.049	18.951	0.534	-16.606
10/28/04	20:32:12	507.5192	-61.049	18.951	0.534	-16.606
10/28/04	20:34:12	509.5192	-61.049	18.951	0.534	-16.613
10/28/04	20:36:12	511.5192	-61.063	18.937	0.520	-16.613
10/28/04	20:38:12	513.5192	-61.049	18.951	0.534	-16.620
10/28/04	20:40:12	515.5192	-61.063	18.937	0.520	-16.620
10/28/04	20:42:12	517.5192	-61.063	18.937	0.520	-16.627
10/28/04	20:44:12	519.5192	-61.063	18.937	0.520	-16.627
10/28/04	20:46:12	521.5192	-61.077	18.923	0.506	-16.627
10/28/04	20:48:12	523.5192	-61.077	18.923	0.506	-16.634
10/28/04	20:50:12	525.5192	-61.077	18.923	0.506	-16.634

10/28/04	20:52:12	527.5192	-61.092	18.908	0.491	-16.634
10/28/04	20:54:12	529.5192	-61.092	18.908	0.491	-16.641
10/28/04	20:56:12	531.5192	-61.092	18.908	0.491	-16.641
10/28/04	20:58:12	533.5192	-61.092	18.908	0.491	-16.641
10/28/04	21:00:12	535.5192	-61.077	18.923	0.506	-16.641
10/28/04	21:02:12	537.5192	-61.092	18.908	0.491	-16.649
10/28/04	21:04:12	539.5192	-61.092	18.908	0.491	-16.641
10/28/04	21:06:12	541.5192	-61.092	18.908	0.491	-16.649
10/28/04	21:08:12	543.5192	-61.106	18.894	0.477	-16.656
10/28/04	21:10:12	545.5192	-61.106	18.894	0.477	-16.656
10/28/04	21:12:12	547.5192	-61.106	18.894	0.477	-16.656
10/28/04	21:14:12	549.5192	-61.106	18.894	0.477	-16.656
10/28/04	21:16:12	551.5192	-61.106	18.894	0.477	-16.656
10/28/04	21:18:12	553.5192	-61.092	18.908	0.491	-16.663
10/28/04	21:20:12	555.5192	-61.092	18.908	0.491	-16.663
10/28/04	21:22:12	557.5192	-61.092	18.908	0.491	-16.663
10/28/04	21:24:12	559.5192	-61.092	18.908	0.491	-16.663
10/28/04	21:26:12	561.5192	-61.092	18.908	0.491	-16.663
10/28/04	21:28:12	563.5192	-61.106	18.894	0.477	-16.670
10/28/04	21:30:12	565.5192	-61.106	18.894	0.477	-16.670
10/28/04	21:32:12	567.5192	-61.106	18.894	0.477	-16.670
10/28/04	21:34:12	569.5192	-61.106	18.894	0.477	-16.677
10/28/04	21:36:12	571.5192	-61.106	18.894	0.477	-16.677
10/28/04	21:38:12	573.5192	-61.106	18.894	0.477	-16.670
10/28/04	21:40:12	575.5192	-61.121	18.879	0.462	-16.677
10/28/04	21:42:12	577.5192	-61.106	18.894	0.477	-16.677
10/28/04	21:44:12	579.5192	-61.106	18.894	0.477	-16.677
10/28/04	21:46:12	581.5192	-61.121	18.879	0.462	-16.677
10/28/04	21:48:12	583.5192	-61.121	18.879	0.462	-16.677
10/28/04	21:50:12	585.5192	-61.121	18.879	0.462	-16.677
10/28/04	21:52:12	587.5192	-61.106	18.894	0.477	-16.677
10/28/04	21:54:12	589.5192	-61.106	18.894	0.477	-16.677
10/28/04	21:56:12	591.5192	-61.106	18.894	0.477	-16.677
10/28/04	21:58:12	593.5192	-61.106	18.894	0.477	-16.677
10/28/04	22:00:12	595.5192	-61.106	18.894	0.477	-16.677
10/28/04	22:02:12	597.5192	-61.106	18.894	0.477	-16.677
10/28/04	22:04:12	599.5192	-61.106	18.894	0.477	-16.677
10/28/04	22:06:12	601.5192	-61.106	18.894	0.477	-16.677
10/28/04	22:08:12	603.5192	-61.121	18.879	0.462	-16.677
10/28/04	22:10:12	605.5192	-61.106	18.894	0.477	-16.677
10/28/04	22:12:12	607.5192	-61.121	18.879	0.462	-16.677
10/28/04	22:14:12	609.5192	-61.121	18.879	0.462	-16.677
10/28/04	22:16:12	611.5192	-61.121	18.879	0.462	-16.670
10/28/04	22:18:12	613.5192	-61.121	18.879	0.462	-16.670
10/28/04	22:20:12	615.5192	-61.106	18.894	0.477	-16.670
10/28/04	22:22:12	617.5192	-61.106	18.894	0.477	-16.670
10/28/04	22:24:12	619.5192	-61.106	18.894	0.477	-16.670
10/28/04	22:26:12	621.5192	-61.106	18.894	0.477	-16.670
10/28/04	22:28:12	623.5192	-61.106	18.894	0.477	-16.670
10/28/04	22:30:12	625.5192	-61.106	18.894	0.477	-16.670
10/28/04	22:32:12	627.5192	-61.106	18.894	0.477	-16.670
10/28/04	22:34:12	629.5192	-61.106	18.894	0.477	-16.663
10/28/04	22:36:12	631.5192	-61.106	18.894	0.477	-16.663
10/28/04	22:38:12	633.5192	-61.106	18.894	0.477	-16.663
10/28/04	22:40:12	635.5192	-61.106	18.894	0.477	-16.649
10/28/04	22:42:12	637.5192	-61.106	18.894	0.477	-16.663
10/28/04	22:44:12	639.5192	-61.092	18.908	0.491	-16.663
10/28/04	22:46:12	641.5192	-61.092	18.908	0.491	-16.649

10/28/04	22:48:12	643.5192	-61.092	18.908	0.491	-16.649
10/28/04	22:50:12	645.5192	-61.092	18.908	0.491	-16.649
10/28/04	22:52:12	647.5192	-61.092	18.908	0.491	-16.641
10/28/04	22:54:12	649.5192	-61.077	18.923	0.506	-16.641
10/28/04	22:56:12	651.5192	-61.077	18.923	0.506	-16.634
10/28/04	22:58:12	653.5192	-61.077	18.923	0.506	-16.634
10/28/04	23:00:12	655.5192	-61.077	18.923	0.506	-16.634
10/28/04	23:02:12	657.5192	-61.077	18.923	0.506	-16.627
10/28/04	23:04:12	659.5192	-61.077	18.923	0.506	-16.634
10/28/04	23:06:12	661.5192	-61.063	18.937	0.520	-16.627
10/28/04	23:08:12	663.5192	-61.063	18.937	0.520	-16.627
10/28/04	23:10:12	665.5192	-61.063	18.937	0.520	-16.627
10/28/04	23:12:12	667.5192	-61.063	18.937	0.520	-16.627
10/28/04	23:14:12	669.5192	-61.049	18.951	0.534	-16.613
10/28/04	23:16:12	671.5192	-61.063	18.937	0.520	-16.620
10/28/04	23:18:12	673.5192	-61.049	18.951	0.534	-16.606
10/28/04	23:20:12	675.5192	-61.063	18.937	0.520	-16.613
10/28/04	23:22:12	677.5192	-61.049	18.951	0.534	-16.606
10/28/04	23:24:12	679.5192	-61.049	18.951	0.534	-16.606
10/28/04	23:26:12	681.5192	-61.049	18.951	0.534	-16.606
10/28/04	23:28:12	683.5192	-61.049	18.951	0.534	-16.598
10/28/04	23:30:12	685.5192	-61.034	18.966	0.549	-16.598
10/28/04	23:32:12	687.5192	-61.034	18.966	0.549	-16.591
10/28/04	23:34:12	689.5192	-61.034	18.966	0.549	-16.591
10/28/04	23:36:12	691.5192	-61.034	18.966	0.549	-16.591
10/28/04	23:38:12	693.5192	-61.020	18.980	0.563	-16.584
10/28/04	23:40:12	695.5192	-61.034	18.966	0.549	-16.577
10/28/04	23:42:12	697.5192	-61.020	18.980	0.563	-16.570
10/28/04	23:44:12	699.5192	-61.020	18.980	0.563	-16.570
10/28/04	23:46:12	701.5192	-61.020	18.980	0.563	-16.570
10/28/04	23:48:12	703.5192	-61.005	18.995	0.578	-16.570
10/28/04	23:50:12	705.5192	-61.005	18.995	0.578	-16.555
10/28/04	23:52:12	707.5192	-61.005	18.995	0.578	-16.555
10/28/04	23:54:12	709.5192	-60.991	19.009	0.592	-16.555
10/28/04	23:56:12	711.5192	-60.991	19.009	0.592	-16.548
10/28/04	23:58:12	713.5192	-60.991	19.009	0.592	-16.548
10/29/04	0:00:12	715.5192	-60.991	19.009	0.592	-16.548
10/29/04	0:02:12	717.5192	-60.991	19.009	0.592	-16.534
10/29/04	0:04:12	719.5192	-60.991	19.009	0.592	-16.541
10/29/04	0:06:12	721.5192	-60.977	19.023	0.606	-16.534
10/29/04	0:08:12	723.5192	-60.977	19.023	0.606	-16.534
10/29/04	0:10:12	725.5192	-60.977	19.023	0.606	-16.527
10/29/04	0:12:12	727.5192	-60.977	19.023	0.606	-16.520
10/29/04	0:14:12	729.5192	-60.962	19.038	0.621	-16.512
10/29/04	0:16:12	731.5192	-60.962	19.038	0.621	-16.512
10/29/04	0:18:12	733.5192	-60.962	19.038	0.621	-16.512
10/29/04	0:20:12	735.5192	-60.948	19.052	0.635	-16.498
10/29/04	0:22:12	737.5192	-60.948	19.052	0.635	-16.498
10/29/04	0:24:12	739.5192	-60.933	19.067	0.650	-16.491
10/29/04	0:26:12	741.5192	-60.933	19.067	0.650	-16.484
10/29/04	0:28:12	743.5192	-60.933	19.067	0.650	-16.484
10/29/04	0:30:12	745.5192	-60.919	19.081	0.664	-16.484
10/29/04	0:32:12	747.5192	-60.904	19.096	0.679	-16.477
10/29/04	0:34:12	749.5192	-60.904	19.096	0.679	-16.469
10/29/04	0:36:12	751.5192	-60.904	19.096	0.679	-16.462
10/29/04	0:38:12	753.5192	-60.904	19.096	0.679	-16.462
10/29/04	0:40:12	755.5192	-60.890	19.110	0.693	-16.462
10/29/04	0:42:12	757.5192	-60.890	19.110	0.693	-16.455

10/29/04	0:44:12	759.5192	-60.890	19.110	0.693	-16.448
10/29/04	0:46:12	761.5192	-60.876	19.124	0.707	-16.448
10/29/04	0:48:12	763.5192	-60.876	19.124	0.707	-16.433
10/29/04	0:50:12	765.5192	-60.876	19.124	0.707	-16.433
10/29/04	0:52:12	767.5192	-60.876	19.124	0.707	-16.426
10/29/04	0:54:12	769.5192	-60.861	19.139	0.722	-16.433
10/29/04	0:56:12	771.5192	-60.861	19.139	0.722	-16.419
10/29/04	0:58:12	773.5192	-60.847	19.153	0.736	-16.419
10/29/04	1:00:12	775.5192	-60.847	19.153	0.736	-16.412
10/29/04	1:02:12	777.5192	-60.847	19.153	0.736	-16.405
10/29/04	1:04:12	779.5192	-60.847	19.153	0.736	-16.405
10/29/04	1:06:12	781.5192	-60.847	19.153	0.736	-16.398
10/29/04	1:08:12	783.5192	-60.832	19.168	0.751	-16.390
10/29/04	1:10:12	785.5192	-60.832	19.168	0.751	-16.390
10/29/04	1:12:12	787.5192	-60.832	19.168	0.751	-16.390
10/29/04	1:14:12	789.5192	-60.818	19.182	0.765	-16.390
10/29/04	1:16:12	791.5192	-60.832	19.168	0.751	-16.390
10/29/04	1:18:12	793.5192	-60.818	19.182	0.765	-16.376
10/29/04	1:20:12	795.5192	-60.818	19.182	0.765	-16.376
10/29/04	1:22:12	797.5192	-60.804	19.196	0.779	-16.376
10/29/04	1:24:12	799.5192	-60.804	19.196	0.779	-16.369
10/29/04	1:26:12	801.5192	-60.804	19.196	0.779	-16.369
10/29/04	1:28:12	803.5192	-60.804	19.196	0.779	-16.355
10/29/04	1:30:12	805.5192	-60.804	19.196	0.779	-16.362
10/29/04	1:32:12	807.5192	-60.789	19.211	0.794	-16.355
10/29/04	1:34:12	809.5192	-60.789	19.211	0.794	-16.355
10/29/04	1:36:12	811.5192	-60.789	19.211	0.794	-16.347
10/29/04	1:38:12	813.5192	-60.789	19.211	0.794	-16.347
10/29/04	1:40:12	815.5192	-60.775	19.225	0.808	-16.340
10/29/04	1:42:12	817.5192	-60.775	19.225	0.808	-16.333
10/29/04	1:44:12	819.5192	-60.775	19.225	0.808	-16.333
10/29/04	1:46:12	821.5192	-60.775	19.225	0.808	-16.333
10/29/04	1:48:12	823.5192	-60.775	19.225	0.808	-16.326
10/29/04	1:50:12	825.5192	-60.760	19.240	0.823	-16.326
10/29/04	1:52:12	827.5192	-60.760	19.240	0.823	-16.319
10/29/04	1:54:12	829.5192	-60.760	19.240	0.823	-16.319
10/29/04	1:56:12	831.5192	-60.760	19.240	0.823	-16.319
10/29/04	1:58:12	833.5192	-60.760	19.240	0.823	-16.312
10/29/04	2:00:12	835.5192	-60.746	19.254	0.837	-16.312
10/29/04	2:02:12	837.5192	-60.746	19.254	0.837	-16.304
10/29/04	2:04:12	839.5192	-60.746	19.254	0.837	-16.304
10/29/04	2:06:12	841.5192	-60.746	19.254	0.837	-16.304
10/29/04	2:08:12	843.5192	-60.746	19.254	0.837	-16.304
10/29/04	2:10:12	845.5192	-60.746	19.254	0.837	-16.304
10/29/04	2:12:12	847.5192	-60.746	19.254	0.837	-16.304
10/29/04	2:14:12	849.5192	-60.746	19.254	0.837	-16.297
10/29/04	2:16:12	851.5192	-60.746	19.254	0.837	-16.297
10/29/04	2:18:12	853.5192	-60.731	19.269	0.852	-16.297
10/29/04	2:20:12	855.5192	-60.731	19.269	0.852	-16.297
10/29/04	2:22:12	857.5192	-60.731	19.269	0.852	-16.290
10/29/04	2:24:12	859.5192	-60.731	19.269	0.852	-16.297
10/29/04	2:26:12	861.5192	-60.746	19.254	0.837	-16.290
10/29/04	2:28:12	863.5192	-60.731	19.269	0.852	-16.290
10/29/04	2:30:12	865.5192	-60.731	19.269	0.852	-16.290
10/29/04	2:32:12	867.5192	-60.731	19.269	0.852	-16.290
10/29/04	2:34:12	869.5192	-60.731	19.269	0.852	-16.297
10/29/04	2:36:12	871.5192	-60.731	19.269	0.852	-16.297
10/29/04	2:38:12	873.5192	-60.731	19.269	0.852	-16.297

10/29/04	2:40:12	875.5192	-60.731	19.269	0.852	-16.297
10/29/04	2:42:12	877.5192	-60.731	19.269	0.852	-16.297
10/29/04	2:44:12	879.5192	-60.731	19.269	0.852	-16.297
10/29/04	2:46:12	881.5192	-60.746	19.254	0.837	-16.297
10/29/04	2:48:12	883.5192	-60.746	19.254	0.837	-16.297
10/29/04	2:50:12	885.5192	-60.731	19.269	0.852	-16.297
10/29/04	2:52:12	887.5192	-60.746	19.254	0.837	-16.297
10/29/04	2:54:12	889.5192	-60.746	19.254	0.837	-16.290
10/29/04	2:56:12	891.5192	-60.746	19.254	0.837	-16.297
10/29/04	2:58:12	893.5192	-60.746	19.254	0.837	-16.304
10/29/04	3:00:12	895.5192	-60.746	19.254	0.837	-16.304
10/29/04	3:02:12	897.5192	-60.746	19.254	0.837	-16.304
10/29/04	3:04:12	899.5192	-60.746	19.254	0.837	-16.304
10/29/04	3:06:12	901.5192	-60.746	19.254	0.837	-16.304
10/29/04	3:08:12	903.5192	-60.746	19.254	0.837	-16.312
10/29/04	3:10:12	905.5192	-60.746	19.254	0.837	-16.304
10/29/04	3:12:12	907.5192	-60.746	19.254	0.837	-16.304
10/29/04	3:14:12	909.5192	-60.760	19.240	0.823	-16.312
10/29/04	3:16:12	911.5192	-60.760	19.240	0.823	-16.304
10/29/04	3:18:12	913.5192	-60.760	19.240	0.823	-16.312
10/29/04	3:20:12	915.5192	-60.760	19.240	0.823	-16.312
10/29/04	3:22:12	917.5192	-60.760	19.240	0.823	-16.312
10/29/04	3:24:12	919.5192	-60.760	19.240	0.823	-16.319
10/29/04	3:26:12	921.5192	-60.760	19.240	0.823	-16.312
10/29/04	3:28:12	923.5192	-60.775	19.225	0.808	-16.319
10/29/04	3:30:12	925.5192	-60.760	19.240	0.823	-16.326
10/29/04	3:32:12	927.5192	-60.775	19.225	0.808	-16.326
10/29/04	3:34:12	929.5192	-60.775	19.225	0.808	-16.326
10/29/04	3:36:12	931.5192	-60.775	19.225	0.808	-16.326
10/29/04	3:38:12	933.5192	-60.775	19.225	0.808	-16.333
10/29/04	3:40:12	935.5192	-60.775	19.225	0.808	-16.333
10/29/04	3:42:12	937.5192	-60.775	19.225	0.808	-16.333
10/29/04	3:44:12	939.5192	-60.775	19.225	0.808	-16.347
10/29/04	3:46:12	941.5192	-60.789	19.211	0.794	-16.347
10/29/04	3:48:12	943.5192	-60.789	19.211	0.794	-16.355
10/29/04	3:50:12	945.5192	-60.804	19.196	0.779	-16.355
10/29/04	3:52:12	947.5192	-60.789	19.211	0.794	-16.362
10/29/04	3:54:12	949.5192	-60.789	19.211	0.794	-16.362
10/29/04	3:56:12	951.5192	-60.804	19.196	0.779	-16.362
10/29/04	3:58:12	953.5192	-60.804	19.196	0.779	-16.362
10/29/04	4:00:12	955.5192	-60.804	19.196	0.779	-16.362
10/29/04	4:02:12	957.5192	-60.804	19.196	0.779	-16.369
10/29/04	4:04:12	959.5192	-60.804	19.196	0.779	-16.369
10/29/04	4:06:12	961.5192	-60.818	19.182	0.765	-16.376
10/29/04	4:08:12	963.5192	-60.818	19.182	0.765	-16.383
10/29/04	4:10:12	965.5192	-60.818	19.182	0.765	-16.383
10/29/04	4:12:12	967.5192	-60.818	19.182	0.765	-16.390
10/29/04	4:14:12	969.5192	-60.832	19.168	0.751	-16.398
10/29/04	4:16:12	971.5192	-60.847	19.153	0.736	-16.398
10/29/04	4:18:12	973.5192	-60.832	19.168	0.751	-16.405
10/29/04	4:20:12	975.5192	-60.847	19.153	0.736	-16.412
10/29/04	4:22:12	977.5192	-60.847	19.153	0.736	-16.405
10/29/04	4:24:12	979.5192	-60.861	19.139	0.722	-16.412
10/29/04	4:26:12	981.5192	-60.847	19.153	0.736	-16.419
10/29/04	4:28:12	983.5192	-60.861	19.139	0.722	-16.419
10/29/04	4:30:12	985.5192	-60.861	19.139	0.722	-16.426
10/29/04	4:32:12	987.5192	-60.876	19.124	0.707	-16.433
10/29/04	4:34:12	989.5192	-60.876	19.124	0.707	-16.441

10/29/04	4:36:12	991.5192	-60.876	19.124	0.707	-16.441
10/29/04	4:38:12	993.5192	-60.890	19.110	0.693	-16.448
10/29/04	4:40:12	995.5192	-60.890	19.110	0.693	-16.448
10/29/04	4:42:12	997.5192	-60.890	19.110	0.693	-16.455
10/29/04	4:44:12	999.5192	-60.904	19.096	0.679	-16.462
10/29/04	4:46:12	1001.5192	-60.904	19.096	0.679	-16.462
10/29/04	4:48:12	1003.5192	-60.904	19.096	0.679	-16.477
10/29/04	4:50:12	1005.5192	-60.919	19.081	0.664	-16.477
10/29/04	4:52:12	1007.5192	-60.919	19.081	0.664	-16.484
10/29/04	4:54:12	1009.5192	-60.919	19.081	0.664	-16.491
10/29/04	4:56:12	1011.5192	-60.933	19.067	0.650	-16.491
10/29/04	4:58:12	1013.5192	-60.933	19.067	0.650	-16.498
10/29/04	5:00:12	1015.5192	-60.933	19.067	0.650	-16.498
10/29/04	5:02:12	1017.5192	-60.948	19.052	0.635	-16.505
10/29/04	5:04:12	1019.5192	-60.948	19.052	0.635	-16.512
10/29/04	5:06:12	1021.5192	-60.948	19.052	0.635	-16.520
10/29/04	5:08:12	1023.5192	-60.962	19.038	0.621	-16.520
10/29/04	5:10:12	1025.5192	-60.962	19.038	0.621	-16.534
10/29/04	5:12:12	1027.5192	-60.977	19.023	0.606	-16.534
10/29/04	5:14:12	1029.5192	-60.977	19.023	0.606	-16.541
10/29/04	5:16:12	1031.5192	-60.977	19.023	0.606	-16.548
10/29/04	5:18:12	1033.5192	-60.991	19.009	0.592	-16.548
10/29/04	5:20:12	1035.5192	-60.991	19.009	0.592	-16.555
10/29/04	5:22:12	1037.5192	-61.005	18.995	0.578	-16.555
10/29/04	5:24:12	1039.5192	-61.005	18.995	0.578	-16.563
10/29/04	5:26:12	1041.5192	-61.005	18.995	0.578	-16.584
10/29/04	5:28:12	1043.5192	-61.020	18.980	0.563	-16.584
10/29/04	5:30:12	1045.5192	-61.020	18.980	0.563	-16.591
10/29/04	5:32:12	1047.5192	-61.034	18.966	0.549	-16.598
10/29/04	5:34:12	1049.5192	-61.034	18.966	0.549	-16.613
10/29/04	5:36:12	1051.5192	-61.063	18.937	0.520	-16.620
10/29/04	5:38:12	1053.5192	-61.063	18.937	0.520	-16.620
10/29/04	5:40:12	1055.5192	-61.063	18.937	0.520	-16.627
10/29/04	5:42:12	1057.5192	-61.077	18.923	0.506	-16.634
10/29/04	5:44:12	1059.5192	-61.077	18.923	0.506	-16.641
10/29/04	5:46:12	1061.5192	-61.092	18.908	0.491	-16.649
10/29/04	5:48:12	1063.5192	-61.106	18.894	0.477	-16.656
10/29/04	5:50:12	1065.5192	-61.106	18.894	0.477	-16.670
10/29/04	5:52:12	1067.5192	-61.106	18.894	0.477	-16.670
10/29/04	5:54:12	1069.5192	-61.121	18.879	0.462	-16.677
10/29/04	5:56:12	1071.5192	-61.135	18.865	0.448	-16.685
10/29/04	5:58:12	1073.5192	-61.135	18.865	0.448	-16.699
10/29/04	6:00:12	1075.5192	-61.135	18.865	0.448	-16.699
10/29/04	6:02:12	1077.5192	-61.150	18.850	0.433	-16.706
10/29/04	6:04:12	1079.5192	-61.164	18.836	0.419	-16.713
10/29/04	6:06:12	1081.5192	-61.164	18.836	0.419	-16.720
10/29/04	6:08:12	1083.5192	-61.178	18.822	0.405	-16.728
10/29/04	6:10:12	1085.5192	-61.178	18.822	0.405	-16.735
10/29/04	6:12:12	1087.5192	-61.193	18.807	0.390	-16.742
10/29/04	6:14:12	1089.5192	-61.193	18.807	0.390	-16.749
10/29/04	6:16:12	1091.5192	-61.193	18.807	0.390	-16.756
10/29/04	6:18:12	1093.5192	-61.207	18.793	0.376	-16.763
10/29/04	6:20:12	1095.5192	-61.222	18.778	0.361	-16.771
10/29/04	6:22:12	1097.5192	-61.222	18.778	0.361	-16.778
10/29/04	6:24:12	1099.5192	-61.236	18.764	0.347	-16.785
10/29/04	6:26:12	1101.5192	-61.236	18.764	0.347	-16.792
10/29/04	6:28:12	1103.5192	-61.250	18.750	0.333	-16.799
10/29/04	6:30:12	1105.5192	-61.250	18.750	0.333	-16.806

10/29/04	6:32:12	1107.5192	-61.265	18.735	0.318	-16.814
10/29/04	6:34:12	1109.5192	-61.265	18.735	0.318	-16.835
10/29/04	6:36:12	1111.5192	-61.279	18.721	0.304	-16.842
10/29/04	6:38:12	1113.5192	-61.294	18.706	0.289	-16.849
10/29/04	6:40:12	1115.5192	-61.294	18.706	0.289	-16.864
10/29/04	6:42:12	1117.5192	-61.308	18.692	0.275	-16.871
10/29/04	6:44:12	1119.5192	-61.308	18.692	0.275	-16.878
10/29/04	6:46:12	1121.5192	-61.323	18.677	0.260	-16.885
10/29/04	6:48:12	1123.5192	-61.337	18.663	0.246	-16.893
10/29/04	6:50:12	1125.5192	-61.337	18.663	0.246	-16.893
10/29/04	6:52:12	1127.5192	-61.337	18.663	0.246	-16.900
10/29/04	6:54:12	1129.5192	-61.351	18.649	0.232	-16.907
10/29/04	6:56:12	1131.5192	-61.351	18.649	0.232	-16.914
10/29/04	6:58:12	1133.5192	-61.366	18.634	0.217	-16.928
10/29/04	7:00:12	1135.5192	-61.366	18.634	0.217	-16.936
10/29/04	7:02:12	1137.5192	-61.380	18.620	0.203	-16.943
10/29/04	7:04:12	1139.5192	-61.380	18.620	0.203	-16.950
10/29/04	7:06:12	1141.5192	-61.539	18.461	0.044	-16.950
10/29/04	7:08:12	1143.5192	-61.395	18.605	0.188	-16.957
10/29/04	7:10:12	1145.5192	-61.409	18.591	0.174	-16.964
10/29/04	7:12:12	1147.5192	-61.423	18.577	0.160	-16.979
10/29/04	7:14:12	1149.5192	-61.423	18.577	0.160	-16.979
10/29/04	7:16:12	1151.5192	-61.423	18.577	0.160	-16.993
10/29/04	7:18:12	1153.5192	-61.582	18.418	0.001	-16.993

14.468	2.526	30.320
14.511	2.483	30.324
14.547	2.447	30.322
14.59	2.404	30.324
14.619	2.375	30.324
14.655	2.339	30.328
14.698	2.296	30.330
14.719	2.275	30.328
14.755	2.239	30.328
14.777	2.217	30.330
14.805	2.189	30.328
14.834	2.160	30.330
14.849	2.145	30.330
14.892	2.102	30.290
14.913	2.081	30.290
14.935	2.059	30.288
14.963	2.031	30.288
14.985	2.009	30.286
15.006	1.988	30.288
15.021	1.973	30.286
15.056	1.938	30.286
15.071	1.923	30.281
15.085	1.909	30.279
15.114	1.880	30.277
15.135	1.859	30.277
15.15	1.844	30.277
15.171	1.823	30.275
15.193	1.801	30.277
15.207	1.787	30.277
15.229	1.765	30.277
15.236	1.758	30.275
15.257	1.737	30.277
15.279	1.715	30.277
15.293	1.701	30.275
15.322	1.672	30.273
15.336	1.658	30.273
15.351	1.643	30.273
15.372	1.622	30.273
15.386	1.608	30.269
15.401	1.593	30.269
15.415	1.579	30.269
15.429	1.565	30.267
15.437	1.557	30.263
15.451	1.543	30.312
15.458	1.536	30.312
15.472	1.522	30.271
15.487	1.507	30.259
15.508	1.486	30.259
15.515	1.479	30.259
15.515	1.479	30.257
15.53	1.464	30.257
15.53	1.464	30.259
15.544	1.450	30.257
15.544	1.450	30.259
15.551	1.443	30.255
15.559	1.435	30.255
15.566	1.428	30.253
15.566	1.428	30.253

15.573	1.421	30.253
15.573	1.421	30.257
15.58	1.414	30.257
15.587	1.407	30.257
15.587	1.407	30.255
15.587	1.407	30.255
15.58	1.414	30.253
15.587	1.407	30.253
15.594	1.400	30.255
15.587	1.407	30.253
15.594	1.400	30.253
15.594	1.400	30.253
15.602	1.392	30.251
15.594	1.400	30.253
15.602	1.392	30.255
15.594	1.400	30.253
15.602	1.392	30.251
15.609	1.385	30.251
15.609	1.385	30.255
15.609	1.385	30.253
15.609	1.385	30.251
15.609	1.385	30.253
15.609	1.385	30.253
15.609	1.385	30.253
15.616	1.378	30.251
15.609	1.385	30.251
15.609	1.385	30.253
15.616	1.378	30.251
15.609	1.385	30.253
15.616	1.378	30.251
15.616	1.378	30.253
15.609	1.385	30.249
15.609	1.385	30.249
15.616	1.378	30.249
15.616	1.378	30.247
15.616	1.378	30.249
15.616	1.378	30.247
15.623	1.371	30.245
15.623	1.371	30.245
15.623	1.371	30.243
15.623	1.371	30.241
15.623	1.371	30.243
15.63	1.364	30.241
15.63	1.364	30.243
15.623	1.371	30.243
15.637	1.357	30.245
15.63	1.364	30.243
15.637	1.357	30.243
15.645	1.349	30.243
15.645	1.349	30.243
15.645	1.349	30.243
15.645	1.349	30.243
15.645	1.349	30.241
15.652	1.342	30.243
15.652	1.342	30.243
15.659	1.335	30.243
15.652	1.342	30.241
15.659	1.335	30.241

15.673	1.321	30.241
15.659	1.335	30.243
15.68	1.314	30.241
15.68	1.314	30.241
15.68	1.314	30.243
15.68	1.314	30.241
15.688	1.306	30.243
15.688	1.306	30.241
15.688	1.306	30.241
15.695	1.299	30.241
15.688	1.306	30.241
15.702	1.292	30.241
15.702	1.292	30.243
15.702	1.292	30.245
15.702	1.292	30.245
15.709	1.285	30.245
15.709	1.285	30.247
15.709	1.285	30.245
15.716	1.278	30.245
15.716	1.278	30.245
15.731	1.263	30.243
15.723	1.271	30.243
15.731	1.263	30.243
15.738	1.256	30.243
15.738	1.256	30.243
15.745	1.249	30.243
15.752	1.242	30.245
15.752	1.242	30.245
15.759	1.235	30.245
15.767	1.227	30.247
15.767	1.227	30.245
15.774	1.220	30.247
15.774	1.220	30.247
15.781	1.213	30.247
15.788	1.206	30.247
15.788	1.206	30.245
15.795	1.199	30.247
15.795	1.199	30.247
15.81	1.184	30.247
15.81	1.184	30.247
15.817	1.177	30.247
15.817	1.177	30.247
15.824	1.170	30.247
15.831	1.163	30.247
15.831	1.163	30.247
15.838	1.156	30.247
15.845	1.149	30.247
15.845	1.149	30.247
15.853	1.141	30.247
15.86	1.134	30.245
15.867	1.127	30.247
15.867	1.127	30.249
15.867	1.127	30.247
15.881	1.113	30.247
15.881	1.113	30.247
15.896	1.098	30.247
15.903	1.091	30.247
15.903	1.091	30.245

15.917	1.077	30.247
15.917	1.077	30.245
15.924	1.070	30.243
15.939	1.055	30.241
15.946	1.048	30.243
15.946	1.048	30.241
15.953	1.041	30.243
15.953	1.041	30.241
15.96	1.034	30.245
15.967	1.027	30.243
15.967	1.027	30.243
15.982	1.012	30.241
15.989	1.005	30.241
15.996	0.998	30.241
16.003	0.991	30.243
16.01	0.984	30.243
16.01	0.984	30.245
16.018	0.976	30.243
16.032	0.962	30.241
16.039	0.955	30.243
16.039	0.955	30.245
16.039	0.955	30.249
16.053	0.941	30.251
16.061	0.933	30.253
16.068	0.926	30.253
16.068	0.926	30.251
16.082	0.912	30.253
16.082	0.912	30.251
16.089	0.905	30.247
16.104	0.890	30.247
16.111	0.883	30.247
16.118	0.876	30.247
16.111	0.883	30.294
16.139	0.855	30.247
16.147	0.847	30.245
16.154	0.840	30.249
16.161	0.833	30.247
16.168	0.826	30.249
16.182	0.812	30.249
16.182	0.812	30.249
16.19	0.804	30.249
16.19	0.804	30.251
16.204	0.790	30.251
16.211	0.783	30.249
16.226	0.768	30.245
16.226	0.768	30.243
16.233	0.761	30.245
16.24	0.754	30.245
16.247	0.747	30.247
16.261	0.733	30.249
16.261	0.733	30.251
16.276	0.718	30.251
16.276	0.718	30.253
16.29	0.704	30.253
16.29	0.704	30.255
16.297	0.697	30.255
16.304	0.690	30.257
16.312	0.682	30.257

16.319	0.675	30.257
16.326	0.668	30.253
16.333	0.661	30.251
16.34	0.654	30.249
16.355	0.639	30.253
16.355	0.639	30.255
16.362	0.632	30.259
16.376	0.618	30.259
16.376	0.618	30.257
16.383	0.611	30.257
16.39	0.604	30.257
16.39	0.604	30.257
16.398	0.596	30.257
16.405	0.589	30.259
16.412	0.582	30.261
16.412	0.582	30.261
16.426	0.568	30.261
16.433	0.561	30.261
16.441	0.553	30.263
16.448	0.546	30.263
16.455	0.539	30.263
16.462	0.532	30.263
16.462	0.532	30.261
16.469	0.525	30.261
16.477	0.517	30.263
16.498	0.496	30.261
16.498	0.496	30.259
16.505	0.489	30.255
16.512	0.482	30.255
16.52	0.474	30.255
16.527	0.467	30.255
16.534	0.460	30.255
16.534	0.460	30.255
16.534	0.460	30.255
16.541	0.453	30.257
16.555	0.439	30.255
16.555	0.439	30.255
16.563	0.431	30.255
16.57	0.424	30.253
16.57	0.424	30.253
16.577	0.417	30.253
16.577	0.417	30.253
16.584	0.410	30.255
16.591	0.403	30.255
16.591	0.403	30.253
16.598	0.396	30.253
16.598	0.396	30.251
16.606	0.388	30.253
16.606	0.388	30.253
16.613	0.381	30.253
16.613	0.381	30.251
16.62	0.374	30.251
16.62	0.374	30.251
16.627	0.367	30.251
16.627	0.367	30.249
16.627	0.367	30.251
16.634	0.360	30.251
16.634	0.360	30.251

16.634	0.360	30.253
16.641	0.353	30.251
16.641	0.353	30.253
16.641	0.353	30.253
16.641	0.353	30.251
16.649	0.345	30.249
16.641	0.353	30.249
16.649	0.345	30.247
16.656	0.338	30.251
16.656	0.338	30.249
16.656	0.338	30.249
16.656	0.338	30.249
16.656	0.338	30.247
16.663	0.331	30.245
16.663	0.331	30.245
16.663	0.331	30.245
16.663	0.331	30.243
16.663	0.331	30.245
16.67	0.324	30.243
16.67	0.324	30.241
16.67	0.324	30.239
16.677	0.317	30.239
16.677	0.317	30.241
16.67	0.324	30.239
16.677	0.317	30.243
16.677	0.317	30.245
16.677	0.317	30.243
16.677	0.317	30.243
16.677	0.317	30.245
16.677	0.317	30.245
16.677	0.317	30.245
16.677	0.317	30.247
16.677	0.317	30.245
16.677	0.317	30.247
16.677	0.317	30.245
16.677	0.317	30.243
16.677	0.317	30.241
16.677	0.317	30.241
16.677	0.317	30.237
16.677	0.317	30.237
16.677	0.317	30.237
16.677	0.317	30.237
16.67	0.324	30.237
16.67	0.324	30.237
16.67	0.324	30.239
16.67	0.324	30.237
16.67	0.324	30.237
16.67	0.324	30.235
16.67	0.324	30.233
16.67	0.324	30.231
16.67	0.324	30.233
16.663	0.331	30.233
16.663	0.331	30.233
16.663	0.331	30.233
16.649	0.345	30.233
16.663	0.331	30.235
16.663	0.331	30.235
16.649	0.345	30.233

16.649	0.345	30.233
16.649	0.345	30.233
16.641	0.353	30.231
16.641	0.353	30.233
16.634	0.360	30.235
16.634	0.360	30.231
16.634	0.360	30.226
16.627	0.367	30.228
16.634	0.360	30.228
16.627	0.367	30.231
16.627	0.367	30.231
16.627	0.367	30.228
16.627	0.367	30.231
16.613	0.381	30.231
16.62	0.374	30.228
16.606	0.388	30.228
16.613	0.381	30.228
16.606	0.388	30.231
16.606	0.388	30.228
16.606	0.388	30.228
16.598	0.396	30.226
16.598	0.396	30.224
16.591	0.403	30.226
16.591	0.403	30.226
16.591	0.403	30.222
16.584	0.410	30.222
16.577	0.417	30.224
16.57	0.424	30.220
16.57	0.424	30.220
16.57	0.424	30.216
16.57	0.424	30.214
16.555	0.439	30.214
16.555	0.439	30.212
16.555	0.439	30.214
16.548	0.446	30.212
16.548	0.446	30.214
16.548	0.446	30.212
16.534	0.460	30.214
16.541	0.453	30.214
16.534	0.460	30.214
16.534	0.460	30.212
16.527	0.467	30.210
16.52	0.474	30.210
16.512	0.482	30.210
16.512	0.482	30.208
16.512	0.482	30.206
16.498	0.496	30.206
16.498	0.496	30.206
16.491	0.503	30.204
16.484	0.510	30.206
16.484	0.510	30.206
16.484	0.510	30.206
16.477	0.517	30.204
16.469	0.525	30.202
16.462	0.532	30.202
16.462	0.532	30.202
16.462	0.532	30.202
16.455	0.539	30.200

16.448	0.546	30.202
16.448	0.546	30.202
16.433	0.561	30.200
16.433	0.561	30.198
16.426	0.568	30.200
16.433	0.561	30.200
16.419	0.575	30.200
16.419	0.575	30.198
16.412	0.582	30.198
16.405	0.589	30.198
16.405	0.589	30.200
16.398	0.596	30.198
16.39	0.604	30.200
16.39	0.604	30.200
16.39	0.604	30.198
16.39	0.604	30.198
16.39	0.604	30.198
16.376	0.618	30.198
16.376	0.618	30.198
16.376	0.618	30.198
16.369	0.625	30.196
16.369	0.625	30.198
16.355	0.639	30.196
16.362	0.632	30.194
16.355	0.639	30.192
16.355	0.639	30.194
16.347	0.647	30.192
16.347	0.647	30.192
16.34	0.654	30.192
16.333	0.661	30.192
16.333	0.661	30.190
16.333	0.661	30.192
16.326	0.668	30.192
16.326	0.668	30.192
16.319	0.675	30.192
16.319	0.675	30.190
16.319	0.675	30.190
16.312	0.682	30.190
16.312	0.682	30.190
16.304	0.690	30.188
16.304	0.690	30.188
16.304	0.690	30.188
16.304	0.690	30.188
16.304	0.690	30.184
16.304	0.690	30.186
16.297	0.697	30.186
16.297	0.697	30.186
16.297	0.697	30.186
16.297	0.697	30.186
16.29	0.704	30.186
16.297	0.697	30.182
16.29	0.704	30.184
16.29	0.704	30.184
16.29	0.704	30.180
16.29	0.704	30.180
16.297	0.697	30.180
16.297	0.697	30.178
16.297	0.697	30.178

16.297	0.697	30.176
16.297	0.697	30.176
16.297	0.697	30.174
16.297	0.697	30.174
16.297	0.697	30.174
16.297	0.697	30.171
16.297	0.697	30.174
16.29	0.704	30.174
16.297	0.697	30.169
16.304	0.690	30.171
16.304	0.690	30.171
16.304	0.690	30.171
16.304	0.690	30.171
16.304	0.690	30.169
16.312	0.682	30.169
16.304	0.690	30.167
16.304	0.690	30.167
16.312	0.682	30.167
16.304	0.690	30.167
16.312	0.682	30.167
16.312	0.682	30.165
16.312	0.682	30.163
16.319	0.675	30.165
16.312	0.682	30.163
16.319	0.675	30.163
16.326	0.668	30.163
16.326	0.668	30.161
16.326	0.668	30.159
16.326	0.668	30.159
16.333	0.661	30.159
16.333	0.661	30.157
16.333	0.661	30.157
16.347	0.647	30.155
16.347	0.647	30.153
16.355	0.639	30.151
16.355	0.639	30.153
16.362	0.632	30.153
16.362	0.632	30.151
16.362	0.632	30.153
16.362	0.632	30.153
16.362	0.632	30.153
16.369	0.625	30.155
16.369	0.625	30.155
16.376	0.618	30.153
16.383	0.611	30.153
16.383	0.611	30.155
16.39	0.604	30.157
16.398	0.596	30.157
16.398	0.596	30.159
16.405	0.589	30.159
16.412	0.582	30.159
16.405	0.589	30.161
16.412	0.582	30.161
16.419	0.575	30.157
16.419	0.575	30.161
16.426	0.568	30.159
16.433	0.561	30.161
16.441	0.553	30.161

16.441	0.553	30.163
16.448	0.546	30.163
16.448	0.546	30.163
16.455	0.539	30.163
16.462	0.532	30.165
16.462	0.532	30.165
16.477	0.517	30.161
16.477	0.517	30.161
16.484	0.510	30.159
16.491	0.503	30.159
16.491	0.503	30.161
16.498	0.496	30.161
16.498	0.496	30.163
16.505	0.489	30.161
16.512	0.482	30.159
16.52	0.474	30.157
16.52	0.474	30.159
16.534	0.460	30.159
16.534	0.460	30.159
16.541	0.453	30.157
16.548	0.446	30.157
16.548	0.446	30.159
16.555	0.439	30.159
16.555	0.439	30.159
16.563	0.431	30.161
16.584	0.410	30.159
16.584	0.410	30.159
16.591	0.403	30.155
16.598	0.396	30.157
16.613	0.381	30.157
16.62	0.374	30.157
16.62	0.374	30.159
16.627	0.367	30.159
16.634	0.360	30.159
16.641	0.353	30.157
16.649	0.345	30.159
16.656	0.338	30.157
16.67	0.324	30.159
16.67	0.324	30.157
16.677	0.317	30.155
16.685	0.309	30.155
16.699	0.295	30.153
16.699	0.295	30.153
16.706	0.288	30.153
16.713	0.281	30.155
16.72	0.274	30.153
16.728	0.266	30.153
16.735	0.259	30.153
16.742	0.252	30.155
16.749	0.245	30.155
16.756	0.238	30.155
16.763	0.231	30.155
16.771	0.223	30.155
16.778	0.216	30.151
16.785	0.209	30.149
16.792	0.202	30.151
16.799	0.195	30.153
16.806	0.188	30.151

16.814	0.180	30.153
16.835	0.159	30.151
16.842	0.152	30.153
16.849	0.145	30.151
16.864	0.130	30.151
16.871	0.123	30.149
16.878	0.116	30.151
16.885	0.109	30.149
16.893	0.101	30.149
16.893	0.101	30.149
16.9	0.094	30.147
16.907	0.087	30.149
16.914	0.080	30.151
16.928	0.066	30.149
16.936	0.058	30.147
16.943	0.051	30.147
16.95	0.044	30.147
16.95	0.044	30.192
16.957	0.037	30.145
16.964	0.030	30.143
16.979	0.015	30.143
16.979	0.015	30.143
16.993	0.001	30.151
16.993	0.001	30.198

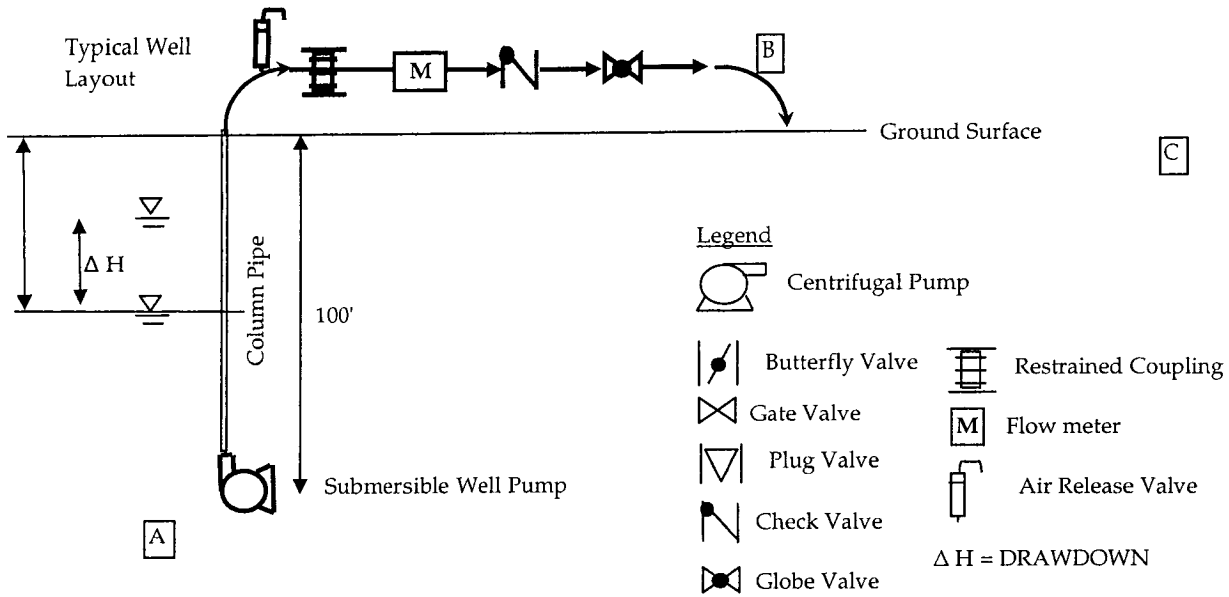

KNOWNs:

- The following are the specified conditions of service for the Wilbur well pump:

Q = 500	gpm
TDH = 231	ft
Max. Motor HP = 50	
Pump setting = 100 feet	BGS (below ground surface)

REQUIREMENTS:

- Total Dynamic Head Calculation
- Selected Pump Head Design Calculation

CALCULATIONS

A. Total Dynamic Head (TDH)

TDH is specified in the Project Manual. The following is the design TDH for the new well pump:

Required TDH =	231 Feet
----------------	-----------------



Client:	<u>Dare County Water Department</u>	Job No.	<u>17952-37350</u>
Project:	<u>North RO Facility Wellfield</u>	Date Checked	<u>3/8/2005</u>
Detail:	<u>Orville Well Hydraulics</u>	Checked By	<u>CDM</u>

B. Selected Pump Head Design Calculation

1. The County requested the design of the submersible well pump be based on 316L SS pumps as manufactured by Goulds.
2. Selected Pump will be a Goulds Model 7TNLC. Please refer to attached pump information for the following calculations:

Design Q = 500 gpm
 TDH = 231 feet

From Single Stage Performance Curve at 500 gpm, single stage head is 60 feet.

No. Stages Required = TDH Required / Head per stage
 231 feet / 60 feet / stage
 3.85 Stages

USE 4 Stages

Actual TDH / stage = 4 stages x 60 feet / stage

Actual TDH = 240 Feet

Motor Horsepower Required

HP Required = $\frac{Q \times TDH}{3960 \times \text{pump efficiency}}$

From Pump performance curve, pump efficiency at 500 gpm is approximately 72%

$$\frac{500 \text{ gpm} \times 240 \text{ feet}}{3960 \times 0.72}$$

HP Required = 39.42

HP Installed = 50 <<< OK..HP installed greater than required.

Discharge Pressure

Static Water Level = 17 feet Below Ground Surface (BGS)

Drawdown = 14.3 feet at 500 gpm based on Step Drawdown test of the new well.

TDH = 240 feet

$$\begin{aligned} \text{Discharge Pressure} &= \frac{\text{TDH} - \text{Drawdown} - \text{Static Water Level}}{2.31} \\ &= \frac{240 - 14.3 - 17}{2.31} \end{aligned}$$

Discharge Pressure = 90.3 PSI This is consistent with operating pressures of the currently operating wells within the system

316 Stainless Steel Submersible Turbine Pumps

5"-11" Diameter
For 6" and larger wells

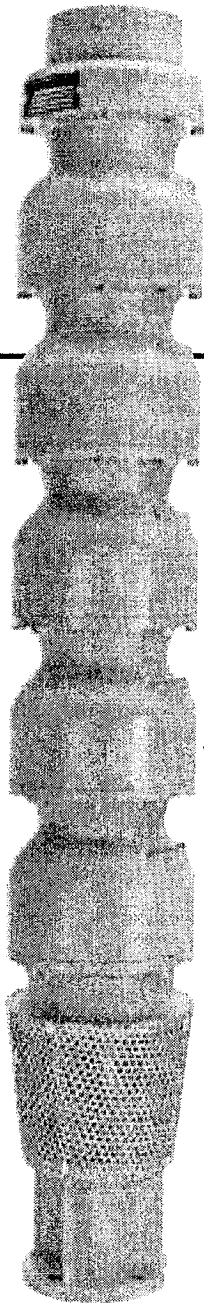

SPECIFICATIONS - 3450 RPM

Model	Max. PSI	Max. TDH	Max. Stage	Operating Range GPM	Best Efficiency Range	Horsepower Range	Discharge Connections	Minimum Well Size
5CNLC	460	1063	18	60 - 180	115	5 - 30	4"	6"
5CNHC	450	1040	17	60 - 200	140	5 - 50	4"	6"
5TNLC	475	1097	20	80 - 225	175	5 - 30	4"	6"
5TNHC	460	1063	20	150 - 300	240	5 - 50	4"	6"
6CNLC	455	1051	13	100 - 225	160	5 - 40	4"	8"
6CNHC	450	1040	13	150 - 300	225	10 - 50	4"	8"
7CNLC	425	982	8	275 - 430	350	10 - 75	4", 6"	8"
7CNHC	405	936	8	300 - 600	450	15 - 100	4", 6"	8"
7TNLC	412	952	8	300 - 650	550	10 - 75	4", 6"	8"
7TNHC	395	913	9	375 - 800	600	15 - 100	4", 6"	8"
9CNLC	495	1144	6	400 - 875	600	30 - 150	6"	10"
9CNHC	490	1132	6	550 - 1200	900	50 - 150	6"	10"
9TNLC	530	1224	7	700 - 1400	1050	40 - 150	6"	10"
9TNHC	462	1067	6	900 - 1700	1300	50 - 150	6"	10"
11CNLC	545	1259	4	500 - 1700	1200	75 - 150	6", 8"	12"

FEATURES

- **Discharge Adapter:** Several discharge sizes available with NPT or Flanged design in 316 SS.
- **Discharge Bearing:** Extra long sealed top bronze bearing insures positive shaft alignment and stabilization for extended life. Standard bronze bearings are of a superior quality Bismuth alloy to ensure tensile strength, yield strength, and percentage elongation results.

- **Intermediate Bowl:** High efficiency design in cast 316 stainless steel.
- **Impellers:** Designed for maximum efficiency with wide range hydraulic coverage.
- **Thrust Washer:** Designed for extra margin of safety against possible momentary upthrust occurring at start-up.

- **Intermediate Bowl Bearings:** Reliable long life Bismuth bronze bearing is standard. Optional rubber or other materials available.
- **Taper Locks:** Accurately machined in 316SS to insure positive locking of impeller to pump shaft.
- **Suction Inlet:** Contoured for smooth flow entrance. Protected by an oversized 304 stainless steel strainer to prevent entrance of damaging solids.

- **Motor Adapter:** Cast 316 stainless steel for corrosion resistance, increased strength and positive motor alignment. Permits easy access to pump/motor coupling.
- **Pump to Motor Coupling:** Large stainless steel coupling accurately matched for perfect alignment, balance and power transmission.
- **Pump Shaft:** 316 stainless steel provides strength and excellent corrosion resistance. Ground and polished for smooth bearing surface.
- **Powered for Continuous Operation:** All ratings are within the working limits of the motor manufacturer. Pump can be operated continuously without fear of damage to the motor.

- **Submersible Motor:**
 - 316 stainless steel corrosion resistant construction
 - 316 stainless steel splined shaft
 - Hermetically sealed windings
 - Anti-track self-healing resin system
 - Water lubrication
 - Kingsbury type thrust bearing
 - Pressure equalizing diaphragm
 - Sand fighter slinger
 - UL 778 recognized.

Goulds Pumps



Model 7TNLC 316 Stainless Steel Pump

Single Stage Performance Curve

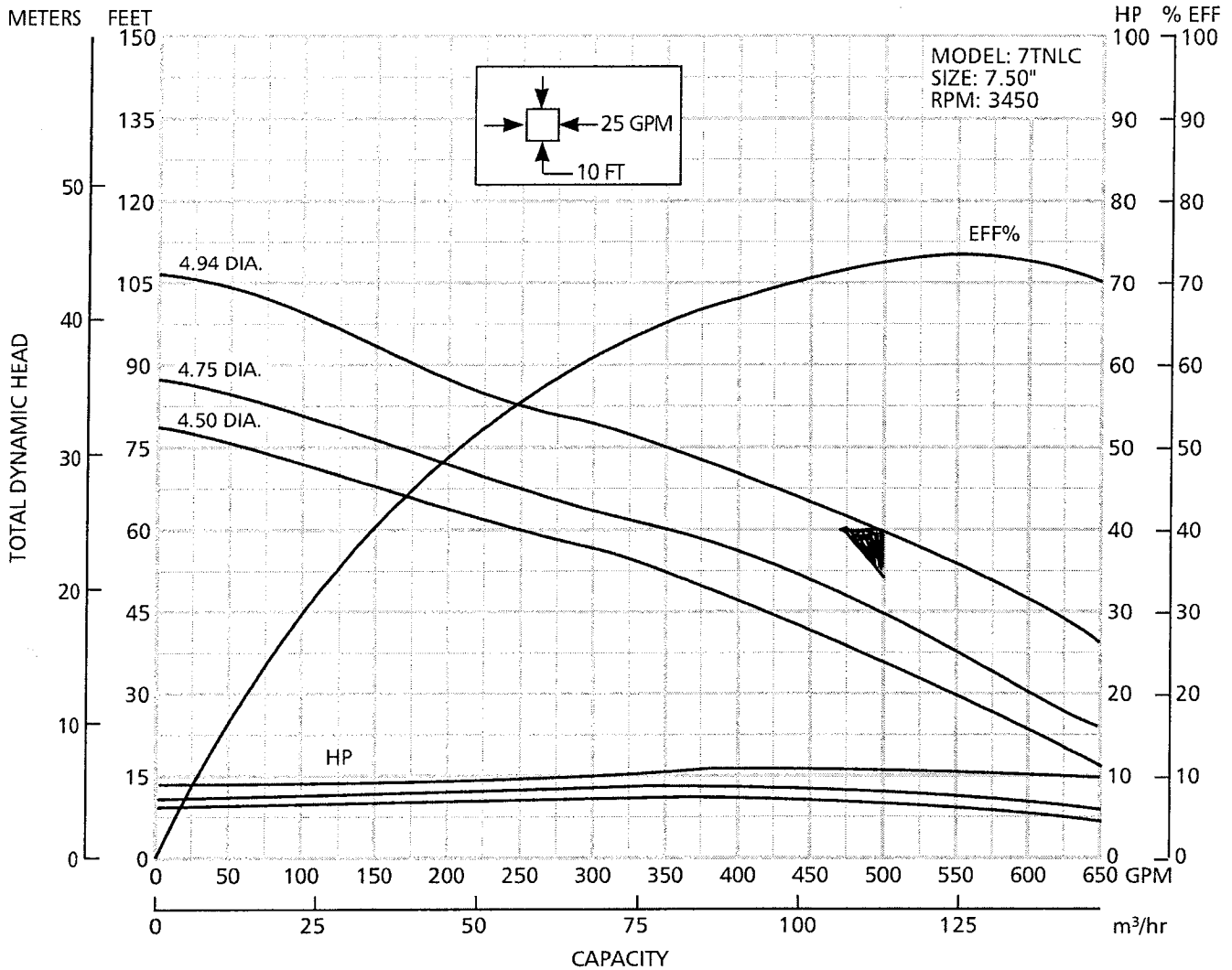

Characteristics based upon pumping clear non-aerated water.
Rating point only is guaranteed. Column and other losses not included.

SPECIFICATIONS

- RPM: 3450, 60 Hz
- Max. O.D. with Cable Guard: 7.5"
- Minimum Well Size: 8"
- Available Discharge Size: 4" & 6"
- Available Motor Size: 6", 8"
- Bowl Connection: Bolted
- Impeller: Enclosed Type
- Bearing Material: Bronze, other materials available.
- Thrust Constant (K): 4.50 lbs./ft.
- Specific Speed: 3684
- Maximum Shutoff Head: 412 PSI / 952 Feet
- Maximum Number of Stages: 8
- Efficiency Correction:
 - 1 Stage deduct 3.0
 - 2 Stages deduct 2.0
 - 3 Stages deduct 1.0

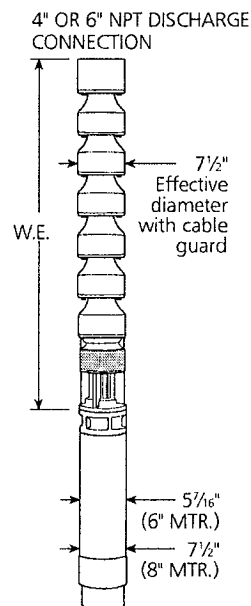

Curves reflect typical performance, refer to factory for certification.

D/E Project Number: 17952-37853
 CDM Job Number: 41798
 Name of Project: Dare County Wellfield Expansion – Wells
 Project Designation:
 Name of Subcontractor or Material Supplier: Goulds Pumps
 Referenced Contract Drawing #: _____
 Referenced Specification Section: 11216
 Name of Manufacturer: Goulds
 Manufacturer Phone No.: _____ Contact: _____
 Description: Pump
 Location of use: Orville

D-11216-004-C SHOP DRAWING
 CONTROL NUMBER
1 REVIEW CODE PER
 SECTION 01300

SHOP DRAWING REVIEW	
ENGINEER'S REVIEW	RESPONSE REQUIRED OF CONTRACTOR
<input checked="" type="checkbox"/> Approved <input type="checkbox"/> Approved As Noted <input type="checkbox"/> Not Approved	<input type="checkbox"/> Confirm <input type="checkbox"/> Resubmit
<input type="checkbox"/> Receipt Not Required (Not subject to Engineer's Review or Approval)	
<small>The Engineer's review of this shop drawing is limited to the review of dimensions, equipment and materials as presented in the Contract plans, specifications, and for design concept. This review does not relieve the Contractor from errors or omissions in the submitted or from the Contractor's responsibility of addressing any deviations from the Contract Documents. The Contractor is responsible for the details and dimensions of fabrication and manufacture, the means, methods, techniques, sequences or procedures of construction and performing its work in a safe manner.</small>	
CDM by <u>TRJ</u>	Date <u>01-10-05</u>



ITT INDUSTRIES - GOULDS PUMPS - TURBINE OPERATION PERFORMANCE TEST RESULTS



CUSTOMER: A.C. SCHULTES
P.O. NUMBER: 10506

PROJECT: TIM PRUIT SS/SUB

S.O. NUMBER: 482075
DATE: 12/15/04

CONDITIONS

PUMP NUM:	1	SP. GR:	1.00	BOWL TDH:	231.0
PUMP TYPE:	VIS	VISC. SSU:	32	PUMP TDH:	0.0
PUMP MODEL:	7TNLC	WATER TEMP:F	63	REQ GPM:	500
STAGES:	4	WITNESSED:	N	MAX GPM:	650
IMP. MATL:	1203	MOTOR SER. #:	17-0021	EFFICIENCY:%	71.7
1ST IMP. DIA:	4.93	1ST IMP. QTY:	2	TEST RPM:	3450
2ND IMP. DIA:	4.50	2ND IMP. QTY:	2	TEST MOTOR:	60 HP
CUST RPM:	3472			TEST LINE:	4
CUST HP:	50	TESTED BY:	CHAD HAYDEN	CURVE RPM:	3472

READINGS DURING TEST

POINTS	1	2	3	4	5	6	7
PSI	186.7	173.0	153.5	128.0	104.7	85.2	65.4
DISCH. FT.	431.28	399.63	354.59	295.68	241.86	196.81	151.07
ELEV. FT.	5.00	5.00	5.00	5.00	5.00	5.00	5.00
VEL. FT.	0.00	0.02	0.10	0.27	0.49	0.67	0.84
PIPE FRIC.	0.00	0.00	0.01	0.03	0.05	0.06	0.08
TORQUE	58.79	57.65	56.75	58.27	60.42	58.09	55.96
INPUT KW	35.70	34.90	34.40	35.20	36.30	35.30	33.90
AMPERES	62.90	62.50	61.70	62.40	63.50	62.70	60.90
VIBRATION	-	-	-	-	-	-	-

TEST DATA RECORDED AT TEST RPM

RPM	3527	3530	3531	3529	3515	3529	3532
GPM	0	102	234	376	506	589	661
TDH-FEET	436.3	404.7	359.7	301.0	247.4	202.5	157.0
PUMP HP	39.5	38.8	38.2	39.2	40.5	39.0	37.6
PUMP EFF	0.0	26.8	55.7	73.0	78.2	77.2	69.6

TEST DATA CONVERTED TO CUSTOMER RPM

RPM	3472	3472	3472	3472	3472	3472	3472
GPM	0	100	230	370	500	580	650
TDH-FEET	422.7	391.5	347.8	291.3	241.4	196.1	151.7
PUMP HP	37.7	36.9	36.3	37.3	39.0	37.2	35.8
PUMP EFF	0.0	26.8	55.7	73.0	78.2	77.2	69.6

Certified Test Results

By: Don Hollis

Title: **ENGINEER**

Date: **Dec 16,2004**

ITT - Goulds Pumps Turbine Operations

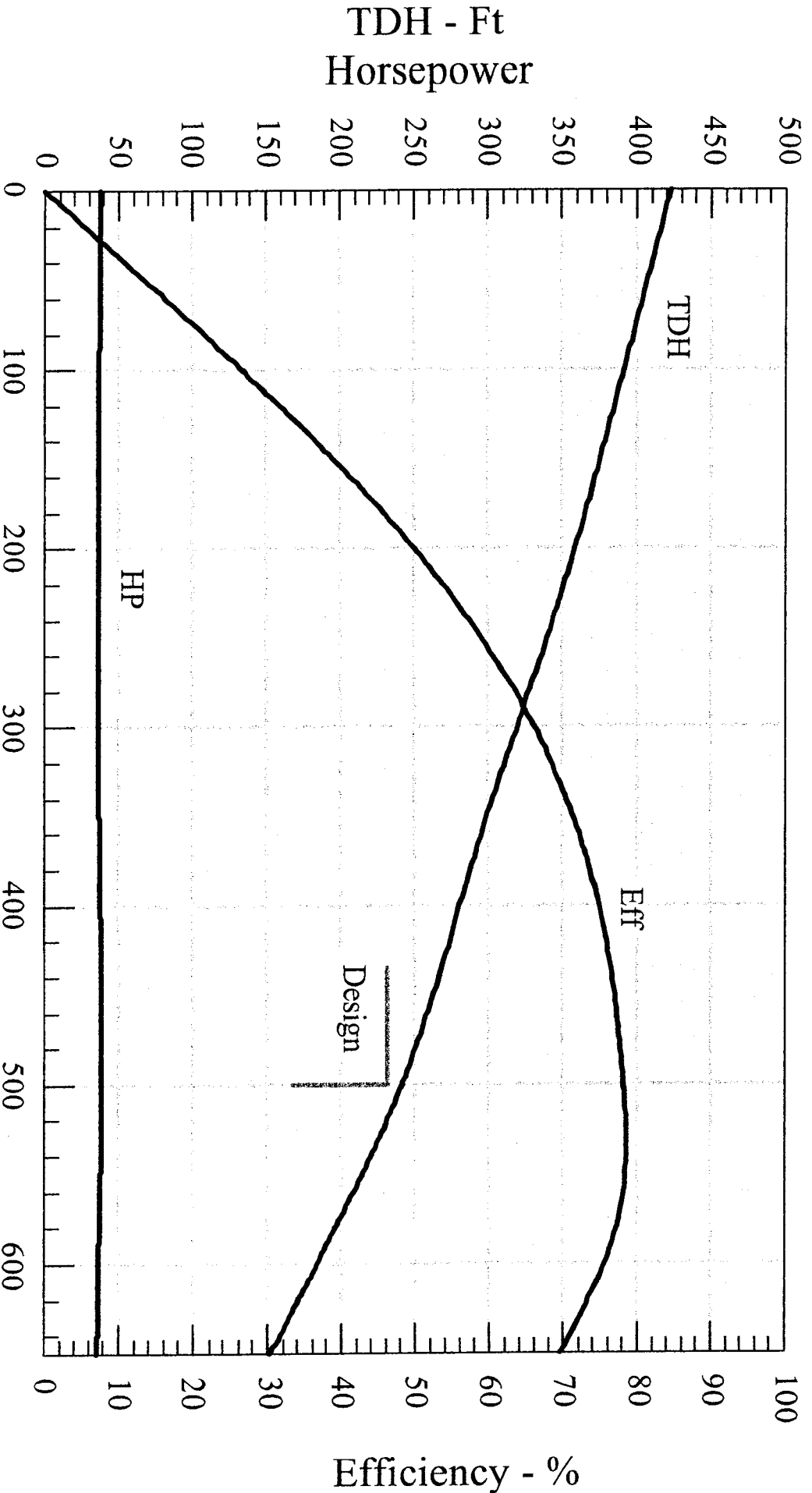

SO: 482075
Model: 7TNLC/4

Flow - GPM
Certified Test Results

Imp Dia: 4.93/4.50 in
Speed: 3472 RPM

By: _____
Title: Engineer
Date: Dec 16, 2004

Efficiency - %



9311 College Parkway, Suite 1
Fort Myers, Florida 33919
tel: 239 432-9494
fax: 239 432-9453

March 4, 2005

Harry F. Bailey
Environmental Engineer
Public Water Supply Section
Department of Environment and Natural Resources
943 Washington Square Mall
Washington, NC 27889

Subject: Well Completion Statement for Production Well Nos. 15 and Orville
Dare County Water System
PWS ID 04-28-030, Dare County

Dear Mr. Bailey:

The purpose of this letter is to advise you that to the best of my knowledge, information and belief, the construction of Production Well No. 15 and Orville has been completed in accordance with the requirements of the State of North Carolina.

If you have any questions or I can be of any further assistance, please do not hesitate to call either me (239/432-9494) or Gary St. John (757/873-8850).

Sincerely,

Wm. Scott Manahan, P.E.
Camp Dresser & McKee Inc.

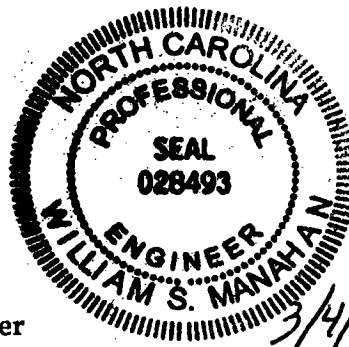

cc: Ken Flatt - Dare County Water
Gary St. John - CDM

ORIGINAL

STATE OF NORTH CAROLINA

Right-of-Way Permit No. RW 5190-03-149
Completes Memorandum of Understanding No. MU-5200-9-9001

United States Department of the Interior
National Park Service
Right-of-Way Permit for
County of Dare

RECEIVED

APR 19 2004

OUTER BANKS GROUP

WHEREAS, the County of Dare, (hereinafter Permittee) and the National Park Service (hereinafter Permitter) entered into a Memorandum of Understanding on July 15, 1999, (No. MU-5200-9-9001) identifying and allocating responsibilities for the construction, transportation and furnishing fresh water supplies to the County of Dare and to the National Park Service including provisions for the drilling of a well at the Wright Brothers National Memorial (hereinafter Park), which will require the issuance of a Right-of-Way to drill, construct, pump and maintain such well within the boundaries of the Park, a unit of the National Park System, United States Department of the Interior; and

WHEREAS, the National Park Service (hereinafter Service) administers the Park that was established as a unit of the National Park System, United States Department of the Interior pursuant to §16 of the Act of March 3, 1933, PL 428-47, Statute 1517 and the Act of March 2, 1927, 44 Statute 1264; and

WHEREAS, the Director of the National Park Service (or his delegate) is required pursuant to 16 U.S.C. 1a-1 to authorize only those uses of land within the Park which will not be in derogation of the values and purposes for which the Park was established, except as may have been or shall be directly and specifically provided by Congress; and

WHEREAS, 16 U.S.C. 79 authorizes the use of rights-of-way through the Park for the supplying of water for domestic, public or any other beneficial uses, provided that the Director (or his delegate) finds that the same is not incompatible with the public interest; and

WHEREAS, the Service has promulgated regulations at Title 36 Code of Federal Regulations, Part 14, regarding rights-of-way over, across and upon the lands administered by the National Park Service; and

WHEREAS, the Service has been delegated the authority to allow such rights-of-way over, across and upon land under the jurisdiction of the Service pursuant to 245 Departmental Manual 5.1; and

WHEREAS, on April 22, 2003, the Permittee's Environmental Consultant did furnish the Park an Environmental Assessment which supports a Finding of No Significant Impact (FONSI).

WHEREAS, the Service has determined that the proposed use of the park lands for the construction, maintenance and operation of the subject use is neither incompatible with the public interest nor inconsistent with the use of such lands for park purposes; and

THEREFORE, the United States, through the Service, an agency of the Department of the Interior, acting pursuant to the authority of 16 U.S.C. 5 or 16 U.S.C. 79 issues this permit to Dare County, 600 Mustian Street, Kill Devil Hills, North Carolina 27948, for a right-of-way across Federal lands within Wright Brothers National Memorial for the construction, drilling, operation and maintenance of a water well.

The Permittee agrees to comply with and be bound by the Service regulations, 36 CFR Part 14, regarding rights-of-way over, across and upon lands administered by the Service, in addition to the terms and conditions set forth in this permit.

MAP AND LEGAL DESCRIPTION OF RIGHT-OF-WAY

The right-of-way shall begin at a point in the Western right-of-way of Croatan Highway (U.S. 158) marked by a concrete monument, said point also marking the Southeastern corner of Lot 30 – Section 1 – The Landing subdivision, said point also marking the Northeastern corner of the property now or formerly owned by The United States Department of the Interior (also known as the Wright Memorial Park), said point also being located 119.82' from the Southern right-of-way of Porthole Court; thence, from said point of beginning, S 28°02'26" E 199.83' along the Western right-of-way of Croatan Highway to a point marked by an iron pin; thence, leaving the Western right-of-way of Croatan Highway, S 61°56'57" W 200.39' to a point marked by an iron pin; thence N 28°00'03" W 200.29' to a point marked by an iron pin, said point also being located on the Southern property line of Lot 33 – Section 1 – The Landing subdivision; thence, N 62°07'46" E 200.25' along the Southern boundary of The Landing subdivision, to the point and place of beginning; said boundary encompassing 40,077 square feet or 0.92 acres.

AUTHORITY TO ENTER INTO AGREEMENT FOR RIGHT-OF-WAY

The Permittee represents and warrants to the Permitter that:

- (1) It is duly authorized and empowered under applicable laws of the STATE NORTH CAROLINA and by its charter and bylaws to enter into and perform this agreement in accordance with the provisions; and
- (2) Its Board of Commissioners, or duly authorized executive committee, has duly approved, and has duly authorized the execution, delivery, and performance by it of this agreement by the CHARIMAN of such; and.
- (3) All action that may be necessary or incidental to the approval of this permit, and the due execution, delivery, and performance by the Permittee has been taken; and

(4) All of the foregoing approvals, authorizations, and actions are in full force and effect at the time of the execution and delivery of this permit.

PERMITTED USE OF RIGHT-OF-WAY BY THE PERMITTEE

The right-of-way is for the sole purpose for the construction, drilling, operation and maintenance of a water well (hereinafter the "subject use") across the above described lands, application for which was made in writing to the Superintendent, Outer Banks Group (hereinafter Superintendent) by the Permittee. That in utilizing the right-of-way the Permittee agrees to comply with and be bound by laws and regulations regarding the use and occupancy of the lands administered by the Service and by the terms of this permit.

DEVIATION FROM APPROVED RIGHT-OF-WAY

The Permittee agrees that it will not deviate from the location of the approved right-of-way in its construction, operation and maintenance of the subject the subject use. All ingress and egress for construction, maintenance and operation of the subject use shall be restricted to the right-of-way. In the event that the Permittee determines that ingress and egress over park lands not included in the right-of-way are necessary for the construction, maintenance and operation of the subject the subject use, then the Permittee must apply, in writing, to the Superintendent for approval of such ingress and egress.

EFFECTIVE DATE OF THE RIGHT-OF-WAY

The effective date of this permit shall be the date of its execution by the Regional Director (or delegate) and the Permittee. The right-of-way permit shall terminate TEN (10) years from the effective date, at noon, (EST) unless prior thereto it is relinquished, abandoned, or otherwise terminated pursuant to the provisions of this permit or of any applicable Federal law or regulation. Permittee has agreed, at the request of the Park, to not commence drilling or construction until January 1, 2004.

RENEWAL OF RIGHT-OF-WAY

Unless relinquished, abandoned, or otherwise terminated pursuant to the provisions of the permit or of any applicable Federal law or regulations, the Permittee may make application to the Superintendent, at least six months prior to its expiration date, for renewal of the right-of-way.

The Permittee shall file a written application, SF 299, in accordance with the existing Service regulations, to renew the right-of-way. The Permittee shall agree to comply with all the laws and regulations existing at such application date governing the occupancy and use of the lands of the Park for the purposes desired. The right-of-way permit may be renewed after full consideration of the application.

DISPOSAL OF PROPERTY ON TERMINATION OF RIGHT-OF-WAY

Upon the termination of the right-of-way permit by expiration or by cancellation for cause, in the absence of any agreement to the contrary, if all monies due the Permitter have been paid, the Permittee shall be allowed six months, or such additional time as may be provided, in which to remove from the right-of-way all property or improvements of any kind placed by them; and if not removed within the time allowed, all such property and improvements may, at the election of the Permitter, be removed and the cost thereof chargeable to and paid by the permittee or become the property of the United States.

NONUSE OR ABANDONMENT

It is understood and agreed by the parties that all or any part of the right-of-way may be terminated at the discretion of the Permitter in the event of nonuse or abandonment for a period of two years by the Permittee. In the case of termination, the Permitter will provide the Permittee with written notice including reasons for the termination.

FEES FOR USE AND OCCUPANCY

The Permitter and Permittee understand and agree that the consideration for utilization of the lands, pursuant to the right-of-way, for municipally operated projects is waived according to 36 CFR 14.26(c)(1).

FEES AND REIMBURSEMENT OF COSTS

Pursuant to 36 CFR. 14.22(a)(2), [(i) for state or local governments or agencies or instrumentalities thereof where the lands will be used for governmental purposes and continue to serve the general public, payment of fees and costs incurred by the Service as a result of this permit are waived.

TERMS AND CONDITIONS

The permit is subject to the following terms and conditions:

- (1) This permit shall not be construed as a permanent interest in the land of the right-of-way or as an abandonment of use and occupancy by the United States, but shall be considered a use of the land as described, anything contained to the contrary notwithstanding.
- (2) This right-of-way permit may be terminated upon breach of any of the stated conditions or at the discretion of the Regional Director of the Service. Permittee will be given written notice

and thirty (30) days to allow an opportunity for corrective actions before termination may occur. The written notice shall describe the specific violations of the permit. If Permittee does not correct the violations to the satisfaction of the Service, or present a reasonable plan acceptable to the Service within the thirty (30) day period, then the NPS shall be entitled to revoke this permit.

(3) The Permittee shall comply with all applicable State and Federal laws and existing regulations promulgated thereunder in the construction, operation and maintenance of the subject use.

(4) The Superintendent shall be notified in writing no less than 30 days prior to the start of initial construction on parklands. An on-site meeting will be conducted no less than one week prior to start of construction between representatives of the park and the Permittee construction/maintenance supervisor to determine and clarify the scope of the project and any requirements of the Service. The Permittee construction/maintenance supervisor will contact the park on the morning of the first day of work and each morning thereafter prior to entering the park, advising the location and extent of work crews and equipment in the park. Except in extraordinary situations and with the agreement of the Superintendent, or as determined at or prior to the on-site meeting above, all work on parklands will be conducted on a Monday through Friday, 8:00 am through 5:00 pm basis. All work on parklands shall be completed to the satisfaction of the Superintendent or his or her representative.

(5) The Permittee shall have a right of ingress and egress within the right-of-way at all times for the purposes of maintaining and operating the existing the subject use and appurtenances.

(6) If any portion of the subject use are to be installed underground within the road shoulders of public roads, they shall comply with the specifications of the highway department having jurisdiction. Detailed procedures of installation are also subject to approval in advance of construction by the Superintendent or his representative.

(7) If required, the Permittee shall file a performance bond with satisfactory surety payable to the Permitter to fully insure compliance with the permit terms and conditions.

(8) The Permittee shall be responsible to pay the Permitter for any damage resulting from this permit which would not reasonably be inherent in the use which the Permittee is authorized to make of the land. The Permitter will give the Permittee written notice of such damage and the Permittee will either take corrective action or pay the indicated amount as agreed upon and approved by the Superintendent.

(9) Use by the Permittee of the land is subject to the right of the park to establish trails, roads, and other improvements and betterments over, upon or through said premises, and further to the use by travelers and others of such roads, trails, and other improvements already existing. If it is necessary to exercise such right, every effort will be made by the park to refrain from unduly interfering with or preventing use of the land by the Permittee for the purposes intended under this permit.

(10) The Permittee shall take adequate measures as directed and approved by the Superintendent to prevent or minimize damage to park resources. This may include restoration, soil conservation and protection measures, landscaping, and repairing roads, trails, fences, etc. The Permittee shall dispose of brush and other refuse as required by the Superintendent. The Superintendent or his representative may inspect the right-of-way area as deemed necessary.

(11) The Permittee will halt any activities and notify the Superintendent upon discovery of threatened or endangered species or archeological, paleontological, or historical findings. All artifacts unearthed remain the property of the park.

(12) No vegetation may be cut or destroyed without first obtaining approval from the Superintendent. Any vegetation that must be removed shall be mitigated as specified by the Superintendent.

(13) Use of pesticides and/or herbicides on parklands is prohibited without prior written approval from the Superintendent.

(14) In the event any facilities covered by this permit should interfere with future Park construction, the Permittee agrees to terminate the use or relocate them at no cost to the Service within 60 days after written notice.

(15) The Permittee agrees to do everything reasonably within its power, both independently and on request of the Superintendent, to prevent and suppress fires resulting from the Permittee's activities on and adjacent to the right-of-way.

(16) The Permittee agrees that the right-of-way shall be subject to the express condition that the use will not unduly interfere with the management and administration by the Service of the lands. Further, the Permittee agrees and consents to the occupancy and use by the park, its Permittees, or lessees of any part of the right-of-way not actually occupied or required by the project, or the full and safe utilization, for necessary operations incident to such management, administration, or disposal.

(17) Upon expiration, revocation or termination of this permit, the Permittee shall leave the lands subject to the permit in as nearly the original condition as possible, as directed and approved by the Superintendent.

(18) The Permittee agrees that in undertaking all activities pursuant to this permit, it will not discriminate against any person because of race, color, religion, sex, or national origin.

(19) No member of or Delegate to Congress or Resident Commissioner shall be admitted to any share or part of this permit or to any benefit that may arise therefrom, but this provision shall not be construed to extend to this permit if made with a corporation for its general benefit.

(20) No transfer of the permit will be recognized unless and until it is first approved in writing by the Regional Director of the Service. Such a transfer must be filed in accordance with

existing regulations at the time of transfer, and must be supported by the stipulation that the assignee agrees to comply with and to be bound by the terms and conditions of the right-of-way.

(21) This agreement is made upon the express condition that the United States, its agents and employees shall be free from all liabilities and claims for damages and/or suits for or by reason of any injury, or death to any person or property of any kind whatsoever, whether to the person or property of the Permittee, its agents or employees, or third parties, from any cause or causes whatsoever while in or upon said premises or any part thereof during the term of this agreement or occasioned by any occupancy or use of said premises or any activity carried on by the Permittee in connection herewith, and the Permittee hereby covenants and agrees to indemnify, defend, save and hold harmless the United States, its agents and employees from all liabilities, charges, expenses and costs on account of or by reason of any such injuries, deaths, liabilities, claims, suits or losses however occurring or damages growing out of the same.

(22) Any alterations to this permit must be in writing and signed by the parties. Renewals will be subject to regulations existing at the time of renewal and such other terms and conditions deemed necessary to protect the public interest.

(23) Any underground utilities previously located within this right-of-way which are damaged or disrupted during maintenance shall be repaired or restored by the Permittee within four hours.

(24) The Permittee shall be responsible for the provision and maintenance of proper signs, barricades or other means of warning motorists and pedestrians of danger during all periods of repair and maintenance.

(25) Nothing herein contained shall be construed as binding the Service to expend in any one fiscal year any sum in excess of appropriations made by Congress or administratively allocated for the purpose of this permit for the fiscal year, or to involve the Service in any contract or other obligation for the further expenditure of money in excess of such appropriations or allocations.

COMPLIANCE

Failure of the Permittee to comply with any provision of this right-of-way permit shall constitute grounds for immediate termination of this permit.

WAIVER NOT CONTINUING

The waiver of any breach of any provision of this right-of-way permit, whether such waiver be expressed or implied, shall not be construed to be a continuing waiver or a waiver of, or consent, to any subsequent or prior breach of the same or any other provision of this permit.

[TEXT CONTINUES NEXT PAGE]

IN WITNESS WHEREOF, the Regional Director of the National Park Service, acting on behalf of the United States, in the exercise of the delegated authority from the Secretary of the Department of the Interior, has caused this Permit of Right-of-Way number RW 5190-03-149 to be executed this 13th day of May, 2004.

for W. H. H. H.
Regional Director
Southeast Region
National Park Service
United States Department of the Interior

ACCEPTED THIS 13th DAY OF April, 2004.

Warren C. Judge, III
Chairman, Board of County Commissioners
Dare County, North Carolina

Attest:

Francis W. Harris
Clerk Secretary, Board of County Commissioners
Dare County, North Carolina

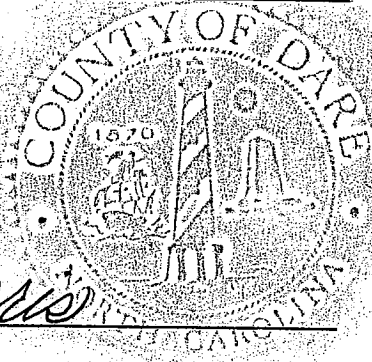

STATE OF NORTH CAROLINA
COUNTY OF DARE

On April 13th, 2004, before me, the undersigned Notary Public in and for the State of North Carolina, personally appeared Warren C. Judge, III, on behalf of the County of Dare And Warren C. Judge, III as Chairman of the Board of Commissioners of said County of Dare personally known to me to be the person whose name is subscribed to the within instrument and acknowledged to me that he executed the same in his authorized capacity, and that by his signature on the instrument, on behalf of the County of Dare executed this instrument. He further acknowledged in due form of the law that he is authorized on behalf of said entity to execute all documents

pertaining hereto and acknowledged to me that the same as his voluntary act and deed on behalf of said County. His signature was attested by Frances W. Harris, Clerk to the Board of Commissioners.

In testimony whereof, I have hereunto set my hand and affixed my official seal at my office in said County in North Carolina on the day and year last above written.

Rhonda L. Cree
Notary Public

My commission expires:

Oct. 19, 2007

Easement Description

Beginning at a point in the Western right-of-way of Croatan Highway (U.S. 158) marked by a concrete monument, said point also marking the Southeastern corner of Lot 30 – Section 1 – The Landing subdivision, said point also marking the Northeastern corner of the property now or formerly owned by The United States Department of the Interior (also known as the Wright Memorial Park), said point also being located 119.82' from the Southern right-of-way of Porthole Court; thence, from said point of beginning, S 28°02'26" E 199.83' along the Western right-of-way of Croatan Highway to a point marked by an iron pin; thence, leaving the Western right-of-way of Croatan Highway, S 61°56'57" W 200.39' to a point marked by an iron pin; thence N 28°00'03" W 200.29' to a point marked by an iron pin, said point also being located on the Southern property line of Lot 33 – Section 1 – The Landing subdivision; thence, N 62°07'46" E 200.25' along the Southern boundary of The Landing subdivision, to the point and place of beginning; said boundary encompassing 40,077 square feet or 0.92 acres.



LEGEND
 1 - 20' ROAD
 2 - 40' ROAD
 3 - 60' ROAD
 4 - 80' ROAD
 5 - 100' ROAD
 6 - 120' ROAD
 7 - 140' ROAD
 8 - 160' ROAD
 9 - 180' ROAD
 10 - 200' ROAD
 11 - 220' ROAD
 12 - 240' ROAD
 13 - 260' ROAD
 14 - 280' ROAD
 15 - 300' ROAD
 16 - 320' ROAD
 17 - 340' ROAD
 18 - 360' ROAD
 19 - 380' ROAD
 20 - 400' ROAD
 21 - 420' ROAD
 22 - 440' ROAD
 23 - 460' ROAD
 24 - 480' ROAD
 25 - 500' ROAD
 26 - 520' ROAD
 27 - 540' ROAD
 28 - 560' ROAD
 29 - 580' ROAD
 30 - 600' ROAD
 31 - 620' ROAD
 32 - 640' ROAD
 33 - 660' ROAD
 34 - 680' ROAD
 35 - 700' ROAD
 36 - 720' ROAD
 37 - 740' ROAD
 38 - 760' ROAD
 39 - 780' ROAD
 40 - 800' ROAD
 41 - 820' ROAD
 42 - 840' ROAD
 43 - 860' ROAD
 44 - 880' ROAD
 45 - 900' ROAD
 46 - 920' ROAD
 47 - 940' ROAD
 48 - 960' ROAD
 49 - 980' ROAD
 50 - 1000' ROAD

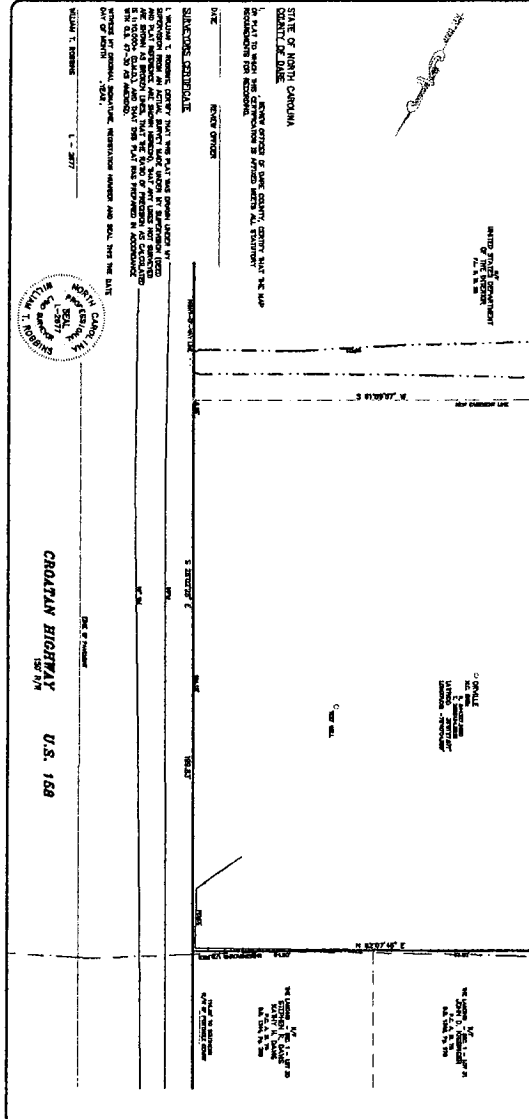

**SURVEY FOR
 DARE COUNTY WATER**
 A NEW BASEMENT IN HILL BEVEL HILLS NEAR THE WHEAT MEMORIAL
 ATLANTIC TOWNSHIP - DARE COUNTY - NORTH CAROLINA

REVISIONS	
NO.	DESCRIPTION
1	AS SHOWN
2	
3	
4	
5	
6	
7	
8	
9	
10	
11	
12	
13	
14	
15	
16	
17	
18	
19	
20	
21	
22	
23	
24	
25	
26	
27	
28	
29	
30	
31	
32	
33	
34	
35	
36	
37	
38	
39	
40	
41	
42	
43	
44	
45	
46	
47	
48	
49	
50	

DARE COUNTY WATER

A NEW BASEMENT IN HILL BEVEL HILLS NEAR THE WHEAT MEMORIAL
 ATLANTIC TOWNSHIP - DARE COUNTY - NORTH CAROLINA

William V. Robbins
 Professional Land Surveyor
 No. 1000
 P.O. Box 1000
 FAYETTEVILLE, NC 27808
 (919) 483-1000
 (919) 483-1000
 www.wvrobbs.com

STATE OF NORTH CAROLINA
 COUNTY OF DARE
 DEPARTMENT OF REVENUE
 DIVISION OF TAXATION
 RECEIVED
 03-23-24

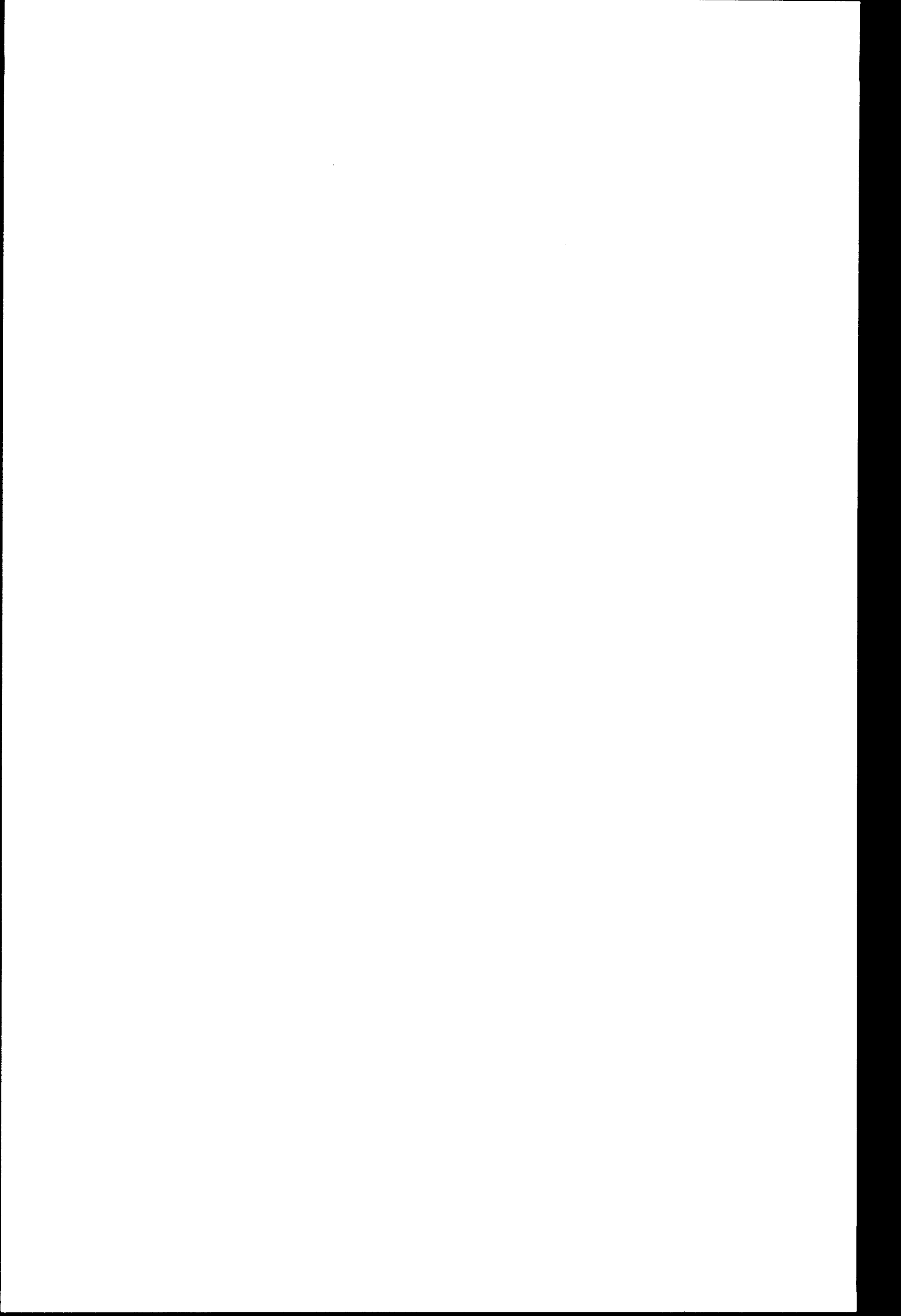

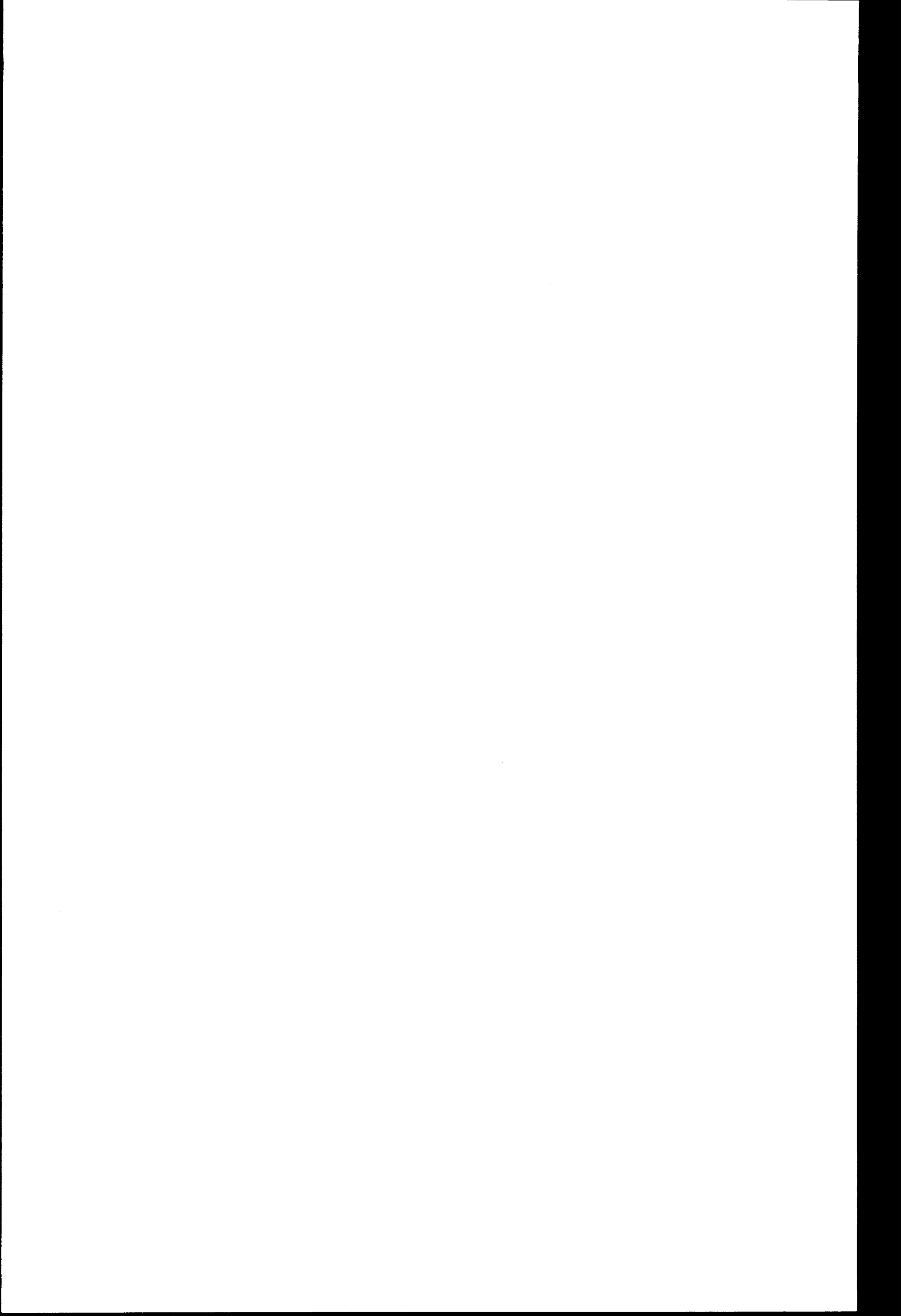



Environmental Chemists, Inc.

6602 Windmill Way • Wilmington, NC 28405
(910) 392-0223 (Lab) • (910) 392-4424 (Fax)

710 Bowsertown Road • Manteo, NC 27954
(252) 473-5702

ANALYTICAL & CONSULTING
CHEMISTS

NCDENR: DWQ CERTIFICATE #94. DLS CERTIFICATE #37729

A.C. Schultes

Index for Orville Well P.O. # M10844

Sample # 15471 Report 4-7107

Collected 10/28/04 @ 08:00 am

- Page 1 & 2 : New Well Inorganics (State Form)
- Page 3 TOC / DOC (State Form)
- Page 4: THM Formation Potential
- Page 5 & 6: Volatile Organic Chemicals (VOCs) (State Form)
- Page 7 & 8: Pesticides and Synthetic Organic Chemicals (SOC) (State Form)
- Page 9: Radiological (State Form)
- Page 10: Asbestos (State Form)
- Page 11: Sample Collection Sheet



Environmental Chemists, Inc.

6602 Windmill Way • Wilmington, NC 28405
(910) 392-0223 Phone • (910) 392-4424 Fax
6602 Windmill Way • Wilmington, NC 28405
(910) 392-0223 (Lab) • (910) 392-4424 (Fax)
NCDENR DWQ Certificate #94, DES Certificate #37729
710 Bowsertown Road • Manteo, NC 27954
(252) 473-5702

ANALYTICAL & CONSULTING
CHEMISTS

NEW WELL INORGANIC CHEMICAL ANALYSIS

PAGE 1 of 11

Note: All information must be supplied for plan review track.

WATER SYSTEM ID #: _____ County: Dare

Name of Water System: Orville Well

Sample Type: Source for Plan Review

Location Where Collected: Orville Well
(Note: Compliance sample MUST be collected at the entry point.)

Location Code: _____

Collected By: Allen Jackson
(Please Print)

Collection Date	Collection Time
<u>10/28/04</u> <small>(MM/DD/YY)</small>	<u>08:00 AM</u> <small>(Specify AM or PM)</small>

Mail Results to (water system representative):
A.C. Schultes

3887 S. NC 41

Wallace, NC 28466

Phone #: (____) _____

Fax #: (____) _____

LABORATORY ID #: **37729**

SAMPLE UNSATISFACTORY RESAMPLE REQUIRED

CONTAM CODE	CONTAMINANT	METHOD CODE	REQUIRED REPORTING LIMIT (R.R.L.)	NOT DETECTED (i.e. < R.R.L.) (X)	QUANTIFIED RESULTS*	ALLOWABLE LIMIT
0100	Turbidity	001	0.10 ntu	<input type="checkbox"/>	<u>0.7</u> mg/L	N/A
1005	Arsenic	169	0.005 mg/L	<input type="checkbox"/>	* <u>0.016</u> mg/L	0.010 mg/L
1010	Barium	169	0.400 mg/L	X	_____ mg/L	2.000 mg/L
1015	Cadmium	169	0.001 mg/L	X	_____ mg/L	0.005 mg/L
1016	Calcium	169	0.001 mg/L	<input type="checkbox"/>	<u>27.9</u> mg/L	N/A
1017	Chloride	<u>128</u>	5.0 mg/L	<input type="checkbox"/>	<u>1211</u> mg/L	250.0 mg/L
1020	Chromium	169	0.020 mg/L	X	_____ mg/L	0.100 mg/L
1022	Copper	<u>169</u>	0.050 mg/L	X	_____ mg/L	1.300 mg/L
1024	Cyanide	154	0.040 mg/L	<input type="checkbox"/>	<u>0.04</u> mg/L	0.200 mg/L
1025	Fluoride	107	0.100 mg/L	<input type="checkbox"/>	_____ mg/L	4.000 mg/L
1028	Iron	169	0.060 mg/L	<input type="checkbox"/>	<u>0.222</u> mg/L	0.300 mg/L
1030	Lead	<u>125</u>	0.003 mg/L	X	_____ mg/L	0.015 mg/L
1031	Magnesium	<u>169</u>	1.0 mg/L	<input type="checkbox"/>	<u>40.2</u> mg/L	N/A
1032	Manganese	169	0.010 mg/L	X	_____ mg/L	0.050 mg/L
1035	Mercury	103	0.0004 mg/L	<input type="checkbox"/>	* <u>0.0033</u> mg/L	0.002 mg/L

*Note: Concentrations for Lead and Copper are action levels, not MCLs.

15471

4-7107

* PLEASE REFER TO AMENDED RESULTS/REPORT DATED 1/24/2005 NEXT PG.



Environmental Chemists, Inc.

6602 Windmill Way • Wilmington, NC 28405
(910) 392-0223 (Lab) • (910) 392-4424 (Fax)
710 Bowsertown Road • Manteo, NC 27954
(252) 473-5702

ANALYTICAL & CONSULTING
CHEMISTS

NCDENR: DWQ CERTIFICATE #94. DLS CERTIFICATE #37729

Customer:

A.C. SCHULTES OF CAROLINA
3887 S. NC 41
Wallace, NC 28466
Attn: Bill Jefferys

Date of Report: January 24, 2005
(amended) *

Purchase Order #: .

Report Number: 4-8067

REPORT OF ANALYSIS

Date Sampled: 12/05/04

Report To: Bill Jefferys

Sampled By: Allen Jackson

Project :

WELL WATER: Date County Orville Well

Parameter	# 17863	Date Analyzed
Mercury, Hg mg/L	< 0.0002	12/10/04
Arsenic, As mg/L	0.008	01/07/05
Arsenic, As mg/L	0.007	01/24/05

Comments:

Reviewed by _____

ANALYTICAL & CONSULTING
CHEMISTS**Environmental Chemists, Inc.**

6602 Windmill Way • Wilmington, NC 28405

(910) 392-0225 (Lab) • (910) 392-4424 (Fax)

710 Bowsertown Road • Manteo, NC 27954

(252) 473-5702

NCDENR: DWQ CERTIFICATE #94. DLS CERTIFICATE #37729

Customer:**A.C. SCHULTES OF CAROLINA**

3887 S. NC 41

Wallace, NC 28466

Attn: Bill Jefferys

Date of Report: December 13, 2004**Purchase Order #:****Report Number:** 4-8067**REPORT OF ANALYSIS****Date Sampled:** 12/05/04**Report To:** Bill Jefferys**Sampled By:** Allen Jackson**Project :****WELL WATER: Date County Orville Well**

Parameter	# 17863	Date Analyzed
Mercury, Hg mg/L	< 0.0002	12/10/04

Comments:

Reviewed by

*R.K. Stigliand**Jamie Hicks*

OXFORD LABORATORIES

Division of Tritest

Analytical and Consulting Chemists

1316 South Fifth Street

Wilmington, N.C. 28401

(910) 763-9793

Fax (910) 343-9688

DATE RECEIVED 12-08-04

DATE REPORTED 12-27-04

4129316

PAGE 1 OF 1

A.C. SCHULTES OF CAROLINA INC
3887 SOUTH NC 41
WALLACE, NC 28466

P.O. # DARE CO ORVILLE

ATTENTION: WILLIAM JEFFREYS

SAMPLE DESCRIPTION: 1 Hg 12-05-04

- 1. DARE COUNTY ORVILLE WELL 12-05-04
- 2. DATE ANALYZED
- 3. METHOD

RESULTS

Mercury, as Hg. PPM

<u>1</u>	<u>2</u>	<u>3</u>
<.0002	12-09	245.1

Denise J. Stalvey
DENISE STALVEY, METALS SUPERVISOR



Analytical & Consulting Chemists

Environmental Chemists, Inc.

6602 Windmill Way • Wilmington, North Carolina 28405

(910) 392-0223 Phone • (910) 392-4424 Fax

EChemW@aol.com

NCDENR: DWQ Certificate #94, DLS Certificate #37729

NEW WELL INORGANIC CHEMICAL ANALYSIS

PAGE 2 of 11

(Continued)

Note: All information must be supplied for plan review credit.

WATER SYSTEM ID #: Orville Well

Location Code: _____

Collection Date

10/28/04

(MM/DD/YY)

Collection Time

08:00 AM

(Specify AM or PM)

LABORATORY ID #: 37729

CONTAM CODE	CONTAMINANT	METHO D CODE	REQUIRED REPORTING LIMIT (R.R.L.)	NOT DETECTED (i.e. <R.R.L.) (X)	QUANTIFIED RESULTS*	ALLOWABLE LIMIT
1036	Nickel	169	0.100 mg/L	X	_____ mg/L	N/A
1040	Nitrate	109	1.00 mg/L	X	_____ mg/L	10.00 mg/L
1041	Nitrite	109	0.10 mg/L	X	_____ mg/L	1.00 mg/L
1045	Selenium	125	0.010 mg/L	X	_____ mg/L	0.050 mg/L
1050	Silver	169	0.05 mg/L	X	_____ mg/L	0.100 mg/L
1052	Sodium	169	1.0 mg/L	<input type="checkbox"/>	<u>850.0</u> mg/L	N/A
1055	Sulfate	173	5.0 mg/L	<input type="checkbox"/>	<u>66.</u> mg/L	250.0 mg/L
1068	Acidity	144	1.0 mg/L	<input type="checkbox"/>	<u>1.0</u> mg/L	N/A
1074	Antimony	125	0.003 mg/L	X	_____ mg/L	0.006 mg/L
1075	Beryllium	169	0.002 mg/L	X	_____ mg/L	0.004 mg/L
1085	Thallium	125	0.001 mg/L	X	_____ mg/L	0.002 mg/L
1095	Zinc	169	1.0 mg/L	X	_____ mg/L	5.0 mg/L
1905	Color	129	5 units	<input type="checkbox"/>	<u>37.</u> mg/L	15 units
1915	Total Hardness	141	1.0 mg/L	<input type="checkbox"/>	<u>236.</u> mg/L	N/A
1925	pH	135	N/A	N/A	<u>8.15</u> Units	6.50 - 8.50 units
1924	Alkalinity	142	1.0 mg/L	<input type="checkbox"/>	<u>325.</u> mg/L	N/A
1930	Total Dissolved Solids	160	10.0 mg/L	<input type="checkbox"/>	<u>2446.</u> mg/L	500.0 mg/L

*Note: Concentrations for Lead and Copper are action levels, not MCLs.

ANALYSES BEGUN:	DATE:	TIME:
	<u>11/01/04</u> (MM/DD/YY)	<u>03:00 PM</u> (Specify AM or PM)
ANALYSES COMPLETED:	DATE:	TIME:
	<u>11/12/04</u> (MM/DD/YY)	<u>04:19 PM</u> (Specify AM or PM)

Laboratory Log #: 15471

Certified By: Tim Stoltz

Julie Niemczura
(Print and sign name)

COMMENTS:

R.K. Stigland Julie Niemczura

REPORT # 4-7107



Consulting Chemists

Environmental Chemists, Inc.

6602 Windmill Way • Wilmington, North Carolina 28405
(910) 392-0223 Phone • (910) 392-4424 Fax
EChemW@aol.com

NCDENR: DWO Certificate #94. DLS Certificate #37729

TOC Requirements-Disinfection Byproduct Precursor Analysis PAGE 3 of 11

Note: All information must be supplied for compliance credit.

Water System ID#: _____ - _____ - _____

County: Dare

Name of Water System: Orville Well

Sample Type: Source Treated Special/Non-compliance

Location Where Collected: Orville Well
(Note: sample MUST be collected from Maximum Chlorine Residence or Distribution sites)

Location Code: _____

Collection Date

10/28/04

(MM/DD/YY)

Collection Time

08:00 AM

(Specify AM or PM)

Collected By: Allen Jackson

Mail Results to (water system representative):

A.C. Schultes of Carolina, Inc.

Telephone No. (____) _____

3887 S. NC 41

Fax No. (____) _____

Wallace, NC 28466

Responsible person's email: _____

Laboratory ID#: 37729

SAMPLE UNSATISFACTORY

RESAMPLE REQUIRED

CONTAM CODE	CONTAMINANT	METHOD CODE	REQUIRED REPORTING LIMIT (R.R.L.)		LESS THAN R.R.L (X)	QUANTIFIED RESULTS*				ALLOWABLE LIMIT		
1927	Alkalinity				1.0 mg/L	<input type="checkbox"/>					mg/L	N/A
2920	Total Organic Carbon (TOC)	<u>1</u>	<u>7</u>	<u>5</u>	1.0 mg/L	<input type="checkbox"/>			<u>5</u>	<u>9</u>	mg/L	N/A
2919	Dissolved Organic Carbon	<u>1</u>	<u>7</u>	<u>5</u>	1.0 mg/L	<input type="checkbox"/>			<u>4</u>	<u>5</u>	mg/L	N/A
2922	Ultraviolet Absorption 254 (UV254)				1.0 m ⁻¹	<input type="checkbox"/>					m ⁻¹	N/A

	DATE:	TIME:
Analysis Begun:	<u>11/02/04</u>	<u>12:13 PM</u>
Analysis Completed:	<u>11/02/04</u>	<u>01:58 PM</u>

Laboratory Log #: 15471

Certified By: Julie Niemczura
(Print and Sign Name)

COMMENTS: R.K. Stigland

Bottle ID # _____

Report # 4-7107



Environmental Chemists, Inc.

6602 Windmill Way • Wilmington, NC 28405
(910) 392-0223 (Lab) • (910) 392-4424 (Fax)

710 Bowsertown Road • Manteo, NC 27954
(252) 473-5702

ANALYTICAL & CONSULTING
CHEMISTS

NCDENR: DWQ CERTIFICATE #94. DLS CERTIFICATE #37729

Customer:

A.C. SCHULTES OF CAROLINA
3887 S. NC 41
Wallace, NC 28466
Attn: Bill Jefferys

Date of Report: December 3, 2004

Purchase Order #:

Report Number: 4-7107

REPORT OF ANALYSIS

Date Sampled: 10/28/04

Report To: Bill Jefferys

Sampled By: Client

Project :

Orville Well # 15471

Page 4 of 11

Trihalomethane Formation Potential (THMFP)

Chlorine residual after incubation = 0.8 ppm Cl₂ from a 30 ppm dose

Chloroform mg/L	= 0.0017
Bromoform mg/L	= 0.1120
Chlorodibromomethane mg/L	= 0.0279
Bromodichloromethane mg/L	= 0.0102

TFP mg/L = 0.1518

4 hour Chlorine Demand = 28.1 ppm Cl₂

Reviewed by R.K. Highland

Jennifer Hicks



Analytical & Consulting Chemists

VOLATILE ORGANIC CHEMICALS ANALYSIS (VOCs)

Note: All information must be supplied for compliance credit.

WATER SYSTEM ID #: _____

County Dare

Name of Water System: Orville Well

Sample Type: Entry Point Special/Non-compliance

Location Where Collected: Orville Well

(Note: Compliance samples MUST be collected at the Entry Point)

Location Code: _____

Collection Date	Collection Time
<u>10/28/04</u> <small>(MM/DD/YY)</small>	<u>08:00 AM</u> <small>(Specify AM or PM)</small>

Collected By: Allen Jackson
(Please Print)

Mail Results to (water system representative):

A.C. Schultes

3887 S. NC 41

Wallace, NC 28466

Phone #: (910) _____

Fax #: (910) _____

*NOTE: Please complete portion above double line on Page 2.

LABORATORY ID #: **37729**

SAMPLE UNSATISFACTORY

RESAMPLE REQUIRED

CONTAM CODE	CONTAMINANT	METHOD CODE	REQUIRED REPORTING LIMIT (R.R.L.)	NOT DETECTED (i.e. <R.R.L.) (X)	QUANTIFIED RESULTS*	ALLOWABLE LIMIT
2030	p-Isopropyltoluene	2 2 1	0.0005 mg/L	X	_____ mg/L	N/A
2210	Chloromethane	2 2 1	0.0005 mg/L	X	_____ mg/L	N/A
2212	Dichlorodifluoromethane	2 2 1	0.0005 mg/L	X	_____ mg/L	N/A
2214	Bromomethane	2 2 1	0.0005 mg/L	X	_____ mg/L	N/A
2216	Chloroethane	2 2 1	0.0005 mg/L	X	_____ mg/L	N/A
2218	Fluorotrichloromethane	2 2 1	0.0005 mg/L	X	_____ mg/L	N/A
2246	Hexachlorobutadiene	2 2 1	0.0005 mg/L	X	_____ mg/L	N/A
2248	Naphthalene	2 2 1	0.0005 mg/L	X	_____ mg/L	N/A
2378	1,2,4-Trichlorobenzene	2 2 1	0.0005 mg/L	X	_____ mg/L	0.07 mg/L
2380	Cis-1,2-Dichloroethylene	2 2 1	0.0005 mg/L	X	_____ mg/L	0.07 mg/L
2408	Dibromomethane	2 2 1	0.0005 mg/L	X	_____ mg/L	N/A
2410	1,1-Dichloropropene	2 2 1	0.0005 mg/L	X	_____ mg/L	N/A
2412	1,3-Dichloropropane	2 2 1	0.0005 mg/L	X	_____ mg/L	N/A
2413	1,3-Dichloropropene	2 2 1	0.0005 mg/L	X	_____ mg/L	N/A
2414	1,2,3-Trichloropropane	2 2 1	0.0005 mg/L	X	_____ mg/L	N/A
2416	2,2-Dichloropropane	2 2 1	0.0005 mg/L	X	_____ mg/L	N/A
2418	1,2,4-Trimethylbenzene	2 2 1	0.0005 mg/L	X	_____ mg/L	N/A
2420	1,2,3-Trichlorobenzene	2 2 1	0.0005 mg/L	X	_____ mg/L	N/A
2422	n-Butylbenzene	2 2 1	0.0005 mg/L	X	_____ mg/L	N/A
2424	1,3,5-Trimethylbenzene	2 2 1	0.0005 mg/L	X	_____ mg/L	N/A
2426	Tert-Butylbenzene	2 2 1	0.0005 mg/L	X	_____ mg/L	N/A
2428	Sec-Butylbenzene	2 2 1	0.0005 mg/L	X	_____ mg/L	N/A
2430	Bromochloromethane	2 2 1	0.0005 mg/L	X	_____ mg/L	N/A
2941	Chloroform	2 2 1	0.0005 mg/L	X	_____ mg/L	N/A

(VOLATILE ORGANIC CHEMICALS ANALYSIS (VOCs))

Note: All information must be supplied for compliance credit continued)

WATER SYSTEM ID #: Orville Well

Location Code: _____

Collection Date

Collection Time

10/28/04

08:00 AM

(MM/DD/YY)

(Specify AM or PM)

LABORATORY ID #: 37729

CONTAM CODE	CONTAMINANT	METHOD CODE	REQUIRED REPORTING LIMIT (R.R.L.)	NOT DETECTED ABOVE R.R.L. (X)	QUANTIFIED RESULTS*	ALLOWABLE LIMIT
2942	Bromoform	2 2 1	0.0005 mg/L	X	_____ mg/L	N/A
2943	Bromodichloromethane	2 2 1	0.0005 mg/L	X	_____ mg/L	N/A
2944	Chlorodibromomethane	2 2 1	0.0005 mg/L	X	_____ mg/L	N/A
2955	Xylenes (Total)	2 2 1	0.0005 mg/L	X	_____ mg/L	10.00 mg/L
2964	Dichloromethane	2 2 1	0.0005 mg/L	X	_____ mg/L	0.005 mg/L
2965	o-Chlorotoluene	2 2 1	0.0005 mg/L	X	_____ mg/L	N/A
2966	p-Chlorotoluene	2 2 1	0.0005 mg/L	X	_____ mg/L	N/A
2967	m-Dichlorobenzene	2 2 1	0.0005 mg/L	X	_____ mg/L	N/A
2968	o-Dichlorobenzene	2 2 1	0.0005 mg/L	X	_____ mg/L	0.60 mg/L
2969	p-Dichlorobenzene	2 2 1	0.0005 mg/L	X	_____ mg/L	0.075 mg/L
2976	Vinyl Chloride	2 2 1	0.0005 mg/L	X	_____ mg/L	0.002 mg/L
2977	1,1-Dichloroethylene	2 2 1	0.0005 mg/L	X	_____ mg/L	0.007 mg/L
2978	1,1-Dichloroethane	2 2 1	0.0005 mg/L	X	_____ mg/L	N/A
2979	Trans-1,2-Dichloroethylene	2 2 1	0.0005 mg/L	X	_____ mg/L	0.10 mg/L
2980	1,2-Dichloroethane	2 2 1	0.0005 mg/L	X	_____ mg/L	0.005 mg/L
2981	1,1,1-Trichloroethane	2 2 1	0.0005 mg/L	X	_____ mg/L	0.20 mg/L
2982	Carbon Tetrachloride	2 2 1	0.0005 mg/L	X	_____ mg/L	0.005 mg/L
2983	1,2-Dichloropropane	2 2 1	0.0005 mg/L	X	_____ mg/L	0.005 mg/L
2984	Trichloroethylene	2 2 1	0.0005 mg/L	X	_____ mg/L	0.005 mg/L
2985	1,1,2-Trichloroethane	2 2 1	0.0005 mg/L	X	_____ mg/L	0.005 mg/L
2986	1,1,1,2-Tetrachloroethane	2 2 1	0.0005 mg/L	X	_____ mg/L	N/A
2987	Tetrachloroethylene	2 2 1	0.0005 mg/L	X	_____ mg/L	0.005 mg/L
2988	1, 1,2,2-Tetrachloroethane	2 2 1	0.0005 mg/L	X	_____ mg/L	N/A
2989	Chlorobenzene	2 2 1	0.0005 mg/L	X	_____ mg/L	0.10 mg/L
2990	Benzene	2 2 1	0.0005 mg/L	X	_____ mg/L	0.005 mg/L
2991	Toluene	2 2 1	0.0005 mg/L	X	_____ mg/L	1.00 mg/L
2992	Ethylbenzene	2 2 1	0.0005 mg/L	X	_____ mg/L	0.70 mg/L
2993	Bromobenzene	2 2 1	0.0005 mg/L	X	_____ mg/L	N/A
2994	Isopropylbenzene	2 2 1	0.0005 mg/L	X	_____ mg/L	N/A
2996	Styrene	2 2 1	0.0005 mg/L	X	_____ mg/L	0.10 mg/L
2998	n-Propylbenzene	2 2 1	0.0005 mg/L	X	_____ mg/L	N/A

*Note: If result exceeds allowable limit, the laboratory must fax analytical results to the State within 48 hours

	DATE:	TIME:
ANALYSES BEGUN:	<u>11/08/04</u> (MM/DD/YY)	<u>03:00 PM</u> (Specify AM or PM)
ANALYSES COMPLETED:	<u>11/10/04</u> (MM/DD/YY)	<u>05:00 PM</u> (Specify AM or PM)

Laboratory Log #: 15471

Certified By: Rick Crowell (Print and sign name)

COMMENTS: R.K. Stigland & Javis Hicks REPORT # 4-7107



Analytical & Consulting Chemists

NCDENR: DWO Certificate #94, DLS Certificate #37729

PESTICIDES AND SYNTHETIC ORGANIC CHEMICALS ANALYSIS (SOCs) PAGE 7 of 11

Note: All information must be supplied for compliance credit.

WATER SYSTEM ID #: _____ County: Dare

Name of Water System: Orville Well

Sample Type: Entry Point Special/Non-compliance

Location Where Collected: Orville Well

(Note: Compliance sample MUST be collected at the Entry Point)

Location Code: _____

Collection Date	Collection Time
<u>10/28/04</u> <small>(MM/DD/YY)</small>	<u>08:00 AM</u> <small>(Specify AM or PM)</small>

Collected By: Allen Jackson
(Please Print)

Mail Results to (water system representative):

A.C. Schultes

3887 S. NC 41

Wallace, NC 28466

Phone #: (910) _____

Fax #: (910) _____

*NOTE: Please complete portion above double line on Page 2.

LABORATORY ID #: 37729

SAMPLE UNSATISFACTORY

RESAMPLE REQUIRED

CONTAM CODE	CONTAMINANT	METHOD CODE	REQUIRED REPORTING LIMIT (R.R.L.)	NOT DETECTED (i.e. < R.R.L.) (X)	QUANTIFIED RESULTS*	ALLOWABLE LIMIT
2005	Endrin	210	0.0001 mg/L	X	_____ mg/L	0.002 mg/L
2010	Lindane	210	0.0002 mg/L	X	_____ mg/L	0.0002 mg/L
2015	Methoxychlor	210	0.0001 mg/L	X	_____ mg/L	0.04 mg/L
2020	Toxaphene	210	0.001 mg/L	X	_____ mg/L	0.003 mg/L
2021	Carbaryl	235	0.004 mg/L	X	_____ mg/L	N/A
2022	Methomyl	235	0.004 mg/L	X	_____ mg/L	N/A
2031	Dalapon	203	0.001 mg/L	X	_____ mg/L	0.2 mg/L
2035	Di(2-ethylhexyl)adipate	225	0.0006 mg/L	X	_____ mg/L	0.4 mg/L
2036	Oxamyl(vydate)	235	0.002 mg/L	X	_____ mg/L	0.2 mg/L
2037	Simazine	210	0.00007 mg/L	X	_____ mg/L	0.004 mg/L
2040	Picloram	203	0.0001 mg/L	X	_____ mg/L	0.5 mg/L
2041	Dinoseb	203	0.0002 mg/L	X	_____ mg/L	0.007 mg/L
2042	Hexachlorocyclopentadiene	210	0.0001 mg/L	X	_____ mg/L	0.05 mg/L
2043	Aldicarb Sulfoxide	235	0.0005 mg/L	X	_____ mg/L	N/A
2044	Aldicarb Sulfone	235	0.0008 mg/L	X	_____ mg/L	N/A
2045	Metolachlor	210	0.0008 mg/L	X	_____ mg/L	N/A
2046	Carbofuran	235	0.0009 mg/L	X	_____ mg/L	0.04 mg/L
2047	Aldicarb	235	0.0005 mg/L	X	_____ mg/L	N/A
2050	Atrazine	210	0.0001 mg/L	X	_____ mg/L	0.003 mg/L
2051	Alachlor	210	0.0002 mg/L	X	_____ mg/L	0.002 mg/L
2065	Heptachlor	210	0.00004 mg/L	X	_____ mg/L	0.0004 mg/L

* Note: If result exceeds allowable limit, the laboratory must fax analytical results to the State within 48 hours.



Analytical & Consulting Chemists

Environmental Chemists, Inc.

6602 Windmill Way • Wilmington, North Carolina 28405

(910) 392-0223 Phone • (910) 392-4424 Fax EChemW@aol.com

NCDENR: DWO Certificate #94, DLS Certificate #37729

PESTICIDES AND SYNTHETIC ORGANIC CHEMICALS ANALYSIS (SOCs) PAGE 8 of 12

(continued)

Note: All information must be supplied for compliance credit.

WATER SYSTEM ID #: Orville Well

Location Code: _____

Collection Date: 10/28/04 Collection Time: 08:00 AM

LABORATORY ID #: 37729

Table with 7 columns: CONTAM CODE, CONTAMINANT, METHOD CODE, REQUIRED REPORTING LIMIT (R.R.L.), NOT DETECTED ABOVE R.R.L. (X), QUANTIFIED RESULTS*, ALLOWABLE LIMIT. Lists various pesticides and their analysis results.

*Note: If result exceeds allowable limit, the laboratory must fax analytical results to the State within 48 hours.

Summary table with columns for ANALYSES BEGUN, ANALYSES COMPLETED, DATE, and TIME. Includes dates 10/29/04 and 11/12/04.

Laboratory Log #: 15471

Certified By: Jim Pittman (Print and sign name)

COMMENTS: R.K. Highland, Jim Pittman (Handwritten signatures)

REPORT # 4-7107



Florida Radiochemistry Services, Inc.

Contact: Michael J. Naumann

5456 Hoffner Ave., Suite 201 Orlando, FL 32812

Phone: (407) 382-7733 Fax: (407) 382-7744

Page 9 of 11

RADIOLOGICAL ANALYSIS

Note: All information must be supplied for compliance credit.

WATER SYSTEM ID #: _____ County: Dare

Name of Water System: Orville Well

Sample Type: Distribution Entry Point Composite Special/Non-compliance

Mail Results to (system representative):

Envirochem

Telephone #: () 919 392 0223

Fax #: () 910 392 4424

Collection Data

Period	Date (MM/DD/YY)	Time (Specify AM or PM)	Loc. Code	Sample Location	Collected By
Single or 1 st Qtr	<u>10/28/04</u>	<u>8:00 AM</u>		<u>Well</u>	<u>A. J.</u>
2 nd Qtr	___/___/___	___:___ M			
3 rd Qtr	___/___/___	___:___ M			
4 th Qtr	___/___/___	___:___ M			

LABORATORY ID #: 1 2 7 0 9

SAMPLE UNSATISFACTORY

RESAMPLE REQUIRED

CONTAM CODE	CONTAMINANT	METHOD CODE	REQUIRED REPORTING LIMIT (R.R.L.)	NOT DETECTED (i.e. < R.R.L.) (X)	QUANTIFIED RESULTS*	COUNTING ERROR	ALLOWABLE LIMIT
4000	Gross Alpha ✓	4 3 5	3 pCi/L	<input type="checkbox"/>	<u>4.1</u> pCi/L	<u>3.3</u>	15 pCi/L
4004	Radon	N/A	100 pCi/L	<input type="checkbox"/>	_____ pCi/L	_____	N/A
4006	Uranium ✓	4 5 6	2 pCi/L	<input checked="" type="checkbox"/>	_____ pCi/L	<u>0.6</u>	20.1 pCi/L
4010	Combined Radium	N/A	N/A	N/A	_____ pCi/L	_____	5 pCi/L
4020	Radium 226 ✓	4 4 6	1 pCi/L	<input checked="" type="checkbox"/>	_____ pCi/L	<u>0.2</u>	3 pCi/L
4030	Radium 228 ✓	4 5 2	1 pCi/L	<input checked="" type="checkbox"/>	_____ pCi/L	<u>0.6</u>	2 pCi/L
4100	Gross Beta ✓	4 3 5	4 pCi/L	<input type="checkbox"/>	<u>36.6</u> pCi/L	<u>6.3</u>	50 pCi/L
4102	Tritium	N/A	1,000 pCi/L	<input type="checkbox"/>	_____ pCi/L	_____	20,000 pCi/L
4172	Strontium 89	N/A	10 pCi/L	<input type="checkbox"/>	_____ pCi/L	_____	N/A
4174	Strontium 90	4 2 5	2 pCi/L	<input type="checkbox"/>	_____ pCi/L	_____	8 pCi/L
4264	Iodine 131	N/A	1 pCi/L	<input type="checkbox"/>	_____ pCi/L	_____	N/A
4270	Cesium 134	N/A	10 pCi/L	<input type="checkbox"/>	_____ pCi/L	_____	N/A

*Note: If result exceeds allowable limit, the laboratory must fax analytical results to the State within 48 hours.

DATE:

TIME:

ANALYSES BEGUN:

11/15/04
(MM/DD/YY)

10:00 AM
(Specify AM or PM)

ANALYSES COMPLETED:

11/23/04
(MM/DD/YY)

14:30 PM
(Specify AM or PM)

Laboratory Log #: 0411085-01

Certified By: MIKE NAUMANN
(Print and sign name)

15471

COMMENTS:

12-31-03

→ PUSH ←

REPORT # 4-7107



ASBESTOS ANALYSIS

Note: All information must be supplied for compliance credit.

WATER SYSTEM ID #: NA

County: Dave

Name of Water System: Orville Well

Sample Type: Distribution Entry Point Special/Non-compliance

Location Where Collected: Well

Location Code: NA

Collection Date	Collection Time
10/28/2004 (MM/DD/YY)	8:00, AM (Specify AM or PM)

Collected By: A. Jackson
(Please Print)

Mail Results to (water system representative):

Envirochem
6602 Windmill Way
Wilmington, NC 28405

LABORATORY ID #: 3 7 7 9 2

SAMPLE UNSATISFACTORY

RESAMPLE REQUIRED

CONTAM CODE	CONTAMINANT	METHOD CODE	REQUIRED REPORTING LIMIT (R.R.L.)	NOT DETECTED (i.e. < R.R.L.) (X)	QUANTIFIED RESULTS 1,2	ALLOWABLE LIMIT
1791	Chrysotile	<u>1 7 2</u>	0.2 MFL	<input checked="" type="checkbox"/>	< 0.17 MFL	7.0 MFL
1792	Amphibole	<u>1 7 2</u>	0.2 MFL	<input checked="" type="checkbox"/>	< 0.17 MFL	7.0 MFL
1094	Total Asbestos	<u>1 7 2</u>	0.2 MFL	<input checked="" type="checkbox"/>	< 0.17 MFL	7.0 MFL

Notes: ¹ MFL = Million Fibers per Liter > 10 µm.

² If result exceeds allowable limit, the laboratory must fax analytical results to the State within 48 hours.

	DATE:	TIME:
ANALYSES BEGUN:	12/07/2004 (MM/DD/YY)	2:30, PM (Specify AM or PM)
ANALYSES COMPLETED:	12/10/2004 (MM/DD/YY)	4:10, PM (Specify AM or PM)

Laboratory Log #: 290402230

Certified By: Essie J. Spencer
(Print and sign name)

COMMENTS: 15471 / Report #4-7107

07/2002

Laboratory should Mail Results to:
Public Water Supply Section, Attn: Data Entry, 1634 Mail Service Center, Raleigh, NC 27699-1634
Fax: 919.715.6637

Environmental Chemists, Inc.

6602 Windmill Way, Wilmington, North Carolina 28405
910-392-0223 phone 910-392-4424 fax Email: EChem@aol.com
NCDENR: DWQ Certificate #94; DLS Certificate #37729 01-15-03

Analytical & Consulting Chemists

COLLECTION SHEET FOR DRINKING WATER

Water System ID#: _____ County: Dare
Name of System: Orville well
Results to: A.C. Schultes
PO # M10844
Phone #: _____
Fax #: _____
Email or Cell #: _____

Requested Test/Method		Collection Date	Collection Time	Sample Type	Location Code	Pres.	Location Where Collected	Lab ID	Report No.
*Sample Type: (E)=Entry Point; D=Distribution; M=Maximum; S=Special/Non-Compliance)									
() Chlorinated		10-28-04	8:00 am					15471	4-7107
Free _____									
Total _____									
() Nitrate () Nitrite									
(X) Inorganics, Regular () New Well (X)									
(X) Trihalomethanes (THM) F.P.									
(X) VOC by EPA 502.2 or () EPA 524.2									
(X) SOC Check appropriate methods listed below:									
(X) EPA Method 504 (EDB + DBCP)									
() EPA Method 507 (N&P Compounds)									
(X) EPA Method 508 (Chlorinated Pesticides)									
(X) EPA Method 515 (Chlorinated Herbicides)									
(X) EPA Method 525.1 (Organic Compounds)									
(X) EPA Method 531.1 (Carbamates)									
() Other <u>Radilogica</u>									
() Other <u>Asbestos</u>									

Collected by: Allen Jackson Date: 10-28-04 Time: 8:15 am

Delivered by: Allen Jackson Date/Time: 10-28-04 8:50 am
Received by: Allen Jackson Date/Time: 10-27-04
Received by: Allen Jackson Date/Time: 10-28-04

Temperature When Sampled: _____ Initials: _____
Temperature When Received: 1°C Initials: ALJ